

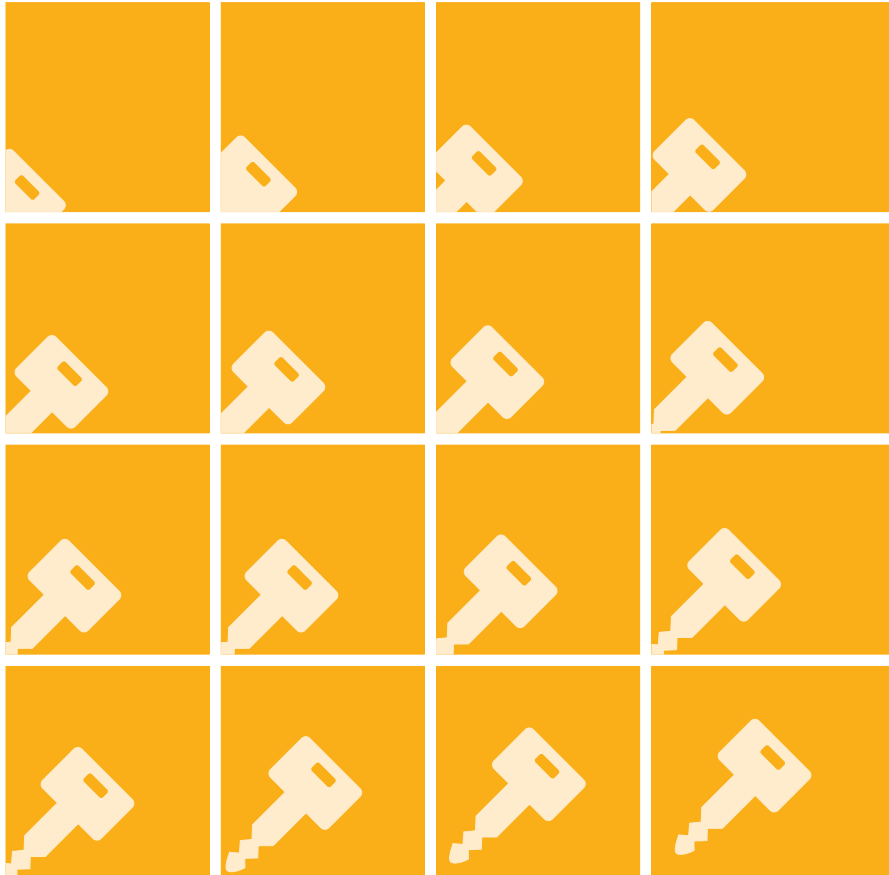

Owner's Manual

2017 Model Year



Pub. No. MH994193

OWNER AND VEHICLE INFORMATION

OWNER NAME: _____

USER/COMPANY NAME: _____

MAILING ADDRESS: _____

CITY, STATE: _____ ZIP: _____

VEHICLE IDENTIFICATION NUMBER: _____

DATE OF DELIVERY (WARRANTY START DATE): _____ / _____ / _____
MO. DAY YR.

SELLING DEALER IMPRINT HERE

INTRODUCTION

Thank you for purchasing a Mitsubishi Fuso FE, FG Truck.

This Owner's Manual explains proper vehicle handling, simple maintenance practices, and the periodic maintenance schedule. Following the instructions in this manual will help assure safe and comfortable operation of your vehicle.

Please take the time to read this publication thoroughly as improper use of the vehicle may result in a breakdown or cause an accident.

After reviewing the owner information, this manual should be stored in the vehicle for convenient referencing and remain with the vehicle when sold.



HOW TO USE THIS MANUAL

- The information in this manual is accurate as of the time of printing. Because of differences in specifications and improvements that may be added after preparation of this manual, some of the descriptions and illustrations may differ from your vehicle.
- This Owner's Manual is used for all vehicle models, and therefore contains descriptions of all available equipment, including options. This may mean that there are descriptions for some equipment that is not available on your particular vehicle.
- This manual contains important cautionary instructions and supplementary information under the following four headings which identify the nature of the instructions and information:

DANGER

Precautions that should be taken when handling dangerous substances such as battery fluid in order to prevent a serious injury or death

WARNING

Precautionary instructions, which, if not observed, could result in serious injury or even death.

CAUTION

NOTE:

Precautionary instructions, which, if not observed, could result in damage to or destruction of equipment or parts.

Suggestions or supplementary information for more efficient use of equipment or better understanding.

- California Proposition 65 Warning

DANGER

THIS PRODUCT CONTAINS OR EMITS CHEMICALS KNOWN TO THE STATE OF CALIFORNIA TO CAUSE CANCER AND BIRTH DEFECTS OR OTHER REPRODUCTIVE HARM.

- The following symbols are used throughout this manual.
 - ⇒ □ : requests that reader should refer to the page of the number indicated.
- The following symbols are used in illustrations.

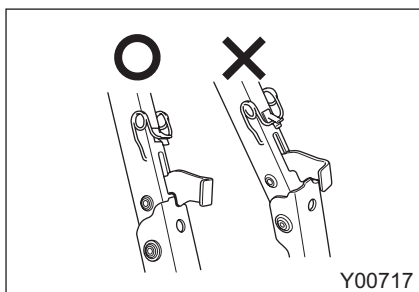

○ :It means "Do this" or "Good condition".

× :It means "Can not", "Do not do this", "Do not let this happen" or "bad condition".

OPERATING PRECAUTIONS

INSPECTION IS VITAL TO THE VEHICLE'S PERFORMANCE.

Inspecting your vehicle at regular intervals is very important for maximizing performance and extending service life. Be sure to perform the pre-operational checks and periodic inspections.

- **Pre-operational checks**

Inspect your vehicle at the start of every day's operation. This will ensure safe and comfortable operation.

- **Periodic inspections**

Inspect your vehicle periodically based on either the distance traveled or period of use.

The intervals between and content of periodic inspections are as shown in the Maintenance Schedule section in this manual. Please adhere to the maintenance schedule carefully.

In addition to maximizing the vehicle's working life, regular inspections also help prevent accidents.

THE VEHICLE'S OPERATING ENVIRONMENT TEMPERATURE IS -25°C TO +40°C (-13°F TO +104°F).

Special care should be taken when the vehicle is used outside of this operating environment temperature range. Please contact your nearest authorized dealer for details.

THE VEHICLE'S BATTERY VOLTAGE IS 12 V.

If you are installing equipment to the vehicle, please check the voltage of the equipment.

If the battery has been discharged and you need to jump-start the vehicle, only do so after checking that the battery voltage of the other vehicle is also 12 V.

AVOID DRIVING ON OFF-ROADS AS MUCH AS POSSIBLE.

Your vehicle is not suitable for permanent off-road application. Permanent off-road use may have an impact on the vehicle's durability.

CONTENTS

1. VEHICLE INFORMATION AND REFERENCE	1-1
2. WARNING LABELS	2-1
3. OPENING AND CLOSING	3-1
4. SEAT AND STEERING WHEEL ADJUSTMENTS	4-1
5. SWITCHES AND CONTROLS	5-1
6. INSTRUMENT AND WARNING LAMPS	6-1
7. STARTING AND OPERATING YOUR VEHICLE	7-1
8. 4WD OPERATION <FG MODELS>	8-1
9. CLIMATE CONTROL SYSTEMS	9-1
10. INTERIOR EQUIPMENT AND ACCESSORIES	10-1
11. COLD WEATHER CARE AND INFORMATION	11-1
12. SIMPLE INSPECTION AND SERVICE	12-1
13. ROADSIDE EMERGENCY INFORMATION	13-1
14. VEHICLE SERVICE SPECIFICATIONS	14-1
15. MAINTENANCE SCHEDULE	15-1
16. ALPHABETICAL INDEX	16-1
17. MAINTENANCE RECORD	17-1

Each chapter has a table of contents on its first page.

1. VEHICLE INFORMATION AND REFERENCE

CHASSIS AND ENGINE NUMBERS	1-2
VEHICLE IDENTIFICATION NUMBER (VIN)	1-3
MAINTENANCE	1-4
FUELS	1-5
DIESEL EXHAUST FLUID (DEF)	1-8
RECORDING, STORING, AND HANDLING OF THE VEHICLE DATA	1-13
REPORTING SAFETY DEFECTS	1-14
OBTAINING SERVICE	1-14

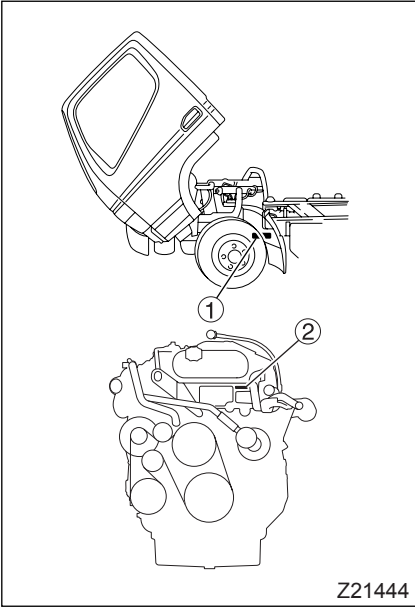

CHASSIS AND ENGINE NUMBERS

1 Chassis number

The chassis number ① is indicated on the left frame, near the left front wheel.

Example: FEC52 - □□□□□□

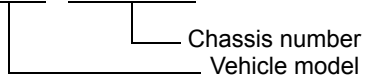

2 Engine number

The engine number ② is indicated on the front side of the cylinder head.

Example: 4P10 - □□□□□□

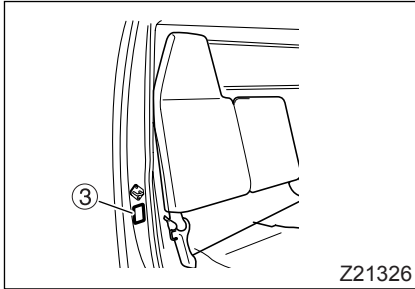
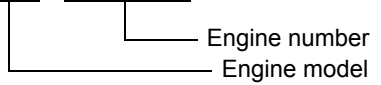

A label ③ indicating the vehicle information including the vehicle model, chassis number, and engine model is located on the assistant driver's door pillar.

VEHICLE IDENTIFICATION NUMBER (VIN)

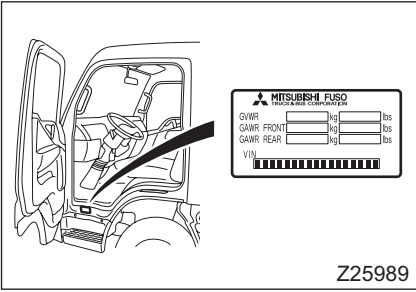

The VIN is stamped on a plate that is located as shown in the illustration.

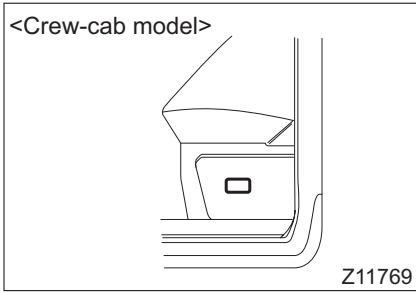

MAINTENANCE

Inspecting your vehicle at regular intervals is very important for maximizing performance and extending service life. It is recommended that you make a habit of performing the following inspections.

This manual describes simple maintenance inspections and procedures that can be carried out by the owner. If you have difficulty or your vehicle needs maintenance work that is not shown in this manual, please refer to an authorized dealer.

1 Pre-operational check

Make a habit of inspecting your vehicle at the start of every day's operation. This will ensure safe and comfortable operation. ⇒  P. 12-12

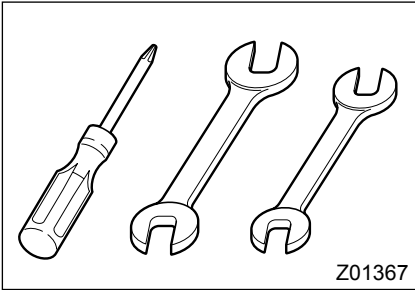

Z01367

2 Periodic inspection

In addition to maximizing the vehicle's working life, regular inspections also help prevent accidents. Periodic inspection is based on either the distance traveled (odometer reading) or period of use (months/years).

The intervals between and content of periodic inspections are as shown in the Maintenance Schedule section. Please adhere to the maintenance schedule carefully.

FUELS

Use only diesel fuels conforming to the following recommendations, without any additives, for diesel engines installed in Mitsubishi Fuso trucks.

1 Diesel fuel requirement property

CAUTION

Use diesel fuel that suits the temperature in which you are using the vehicle. Diesel fuel freezing in the fuel tank or fuel pipes may make the engine difficult to start, or may cause the engine to stop operating.

The following recommendations concerning diesel fuel used with Mitsubishi Fuso diesel engines are given for optimum fuel economy and performance.

Use condition	Recommendation
Normal operation at temperatures above -12°C (10°F).	ASTM D-975 Grade Ultra Low Sulfur Grade 2-D*
Operation at temperatures below -12°C (10°F), or long-hour no-load operation.	ASTM D-975 Grade Ultra Low Sulfur Grade 1-D*

Biodiesel fuel can be used if it has a 5% or lower blend ratio and complies with ASTM D-6751.

NOTE:

** ASTM is an acronym for the American Society for Testing and Materials which recommends fuel containing 0.0015% – basis 15 ppm sulfur or less sulfur content.*

Note that a sulfur content exceeding 0.0015% – basis 15 ppm sulfur deteriorates the performance of emission control device.

To meet fuel requirements, only use good quality diesel fuel from a reputable supplier in your vehicle.

2 Diesel fuel requirement quality

Use only a ultra low sulfur diesel fuel (with a sulfur content of 15 ppm or lower) for refueling your Mitsubishi Fuso diesel engine. If a non-approved fuel is introduced into your vehicle, the catalyst inside the Diesel Particulate Filter (DPF) ability to remove the small particles (particulate matter or PM) in the exhaust gases will be compromised. As a result, your vehicle would not meet the required emission regulations.

3 Danger of fire and explosion by using mixed fuel

Fuel containing 5% gasoline has a flash point as low as 0°C (32°F), which can lead to a fire or explosion while the engine is running.



DANGER

NEVER MIX DIESEL FUEL WITH GASOLINE, GASOHOL OR ALCOHOL.

USE OF FUEL MIXED WITH ONE OR MORE OF THESE COULD LEAD TO A FIRE OR EXPLOSION INVOLVING SERIOUS INJURY, DEATH OR PROPERTY DAMAGE. IF YOU ACCIDENTALLY USE GASOLINE OR ALCOHOL WHEN REFUELING THE VEHICLE, REMOVE ALL OF IT FROM THE FUEL SYSTEM.

4 Adverse effects of mixed fuel on engine

Using diesel fuel mixed with gasoline, alcohol, or both, has the following adverse effects on the engine:

- Fuel viscosity becomes lower, resulting in excessive wear, damage, and failure of fuel system parts.
- Difficulty in starting the engine will result due to a reduced cetane number.



CAUTION

- **The lower the cetane number, the more likely internal engine damage will occur.**
- **Do not add antifreeze agents or other substances to the fuel. They could damage the engine's fuel injection system.**
- **If the fuel tank cap and breather (air hole) become so dirty that the breather gets blocked, the fuel tank may deform and the fuel injection system may fail. Be sure to clean them regularly.**

5 Refueling

WARNING

- Stop the engine before fueling.
- Never smoke when fueling since diesel fuel could ignite or explode. Never operate lighters or other items that emit sparks.
- If you accidentally fill the fuel tank with gasoline on your diesel vehicle, do not start the engine. Starting the engine with gasoline in the fuel tank could cause a fire and explosion involving serious injury or death. The fuel needs to be removed from the tank. Please call your authorized dealer for service.

CAUTION

Be careful not to allow the engine to run out of fuel. Engine stall resulting from an empty tank could cause damage to the fuel injection system.

NOTE:

If the vehicle runs out of fuel, air will enter the fuel system. Simply refueling the vehicle will not make the engine startable ; the air must be bled out of the fuel system.

⇒  P. 13-31

- Wipe clean any dirt, mud or other material that is present around the fuel tank inlet.
- Ensure that dirt, water or other substances do not enter the fuel tank when filling it with fuel.

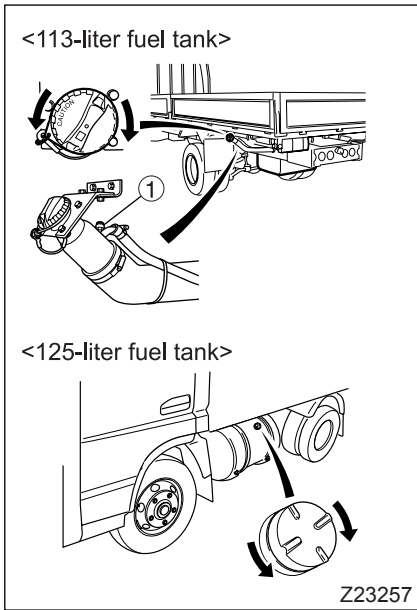

- **113-liter fuel tank**

The fuel tank is at the rear of the vehicle. To open the fuel tank cap, slowly turn it counterclockwise. To close the cap, turn it clockwise until you hear a click.

Fuel tank capacity
113 liters (29.8 gallons)

- **125-liter fuel tank**

The fuel tank is on the left-hand side of the vehicle. To open the cap, slowly turn it counterclockwise. To close the cap, turn it fully clockwise.

Fuel tank capacity
125 liters (33 gallons)

⚠ WARNING

- When filling the fuel tank using a gun-type fuel pump, do not continue pumping after the pump automatically stops. (The tank is full at this point.) When filling the fuel tank using any other method, stop as soon as the surface of the fuel becomes visible through the opening of the fuel filler. If you supply so much fuel that it comes up to the opening, fuel may leak through the check valve ① when the vehicle starts moving and when it stops moving. If fuel leaks, carefully wipe it all up to prevent the risk of fire.
- If the pointer of the fuel gauge is above the “F” mark, do not add the fuel any more.

DIESEL EXHAUST FLUID (DEF)

DEF is injected into the exhaust gas inside the muffler in order to break down the Nitrogen Oxides (NOx) in the exhaust gas into water and nitrogen gas, and thus reduces the amount of NOx.

⇒ P. 5-50

 **WARNING**

DEF is a colorless, transparent, odorless and harmless water solution (urea 32.5%, water 67.5%; Freezing temperature -11°C (12°F)), so no problem will occur if you get it on your skin. However, some persons with delicate skin may in very rare cases get a rash, so carry out the following procedure.

- If DEF gets on your skin, wash it off with water. If there is any change in your skin or it is painful, promptly see a doctor to receive treatment.
- In the event that you accidentally ingest DEF, drink one to two cupfuls of water or milk, and promptly see a doctor to receive treatment.
- If DEF gets into your eyes, immediately wash your eyes with a copious amount of water, then see a doctor to receive treatment.

1 Selecting the proper DEF

Be sure to use DEF that conforms to ISO 22241.
ISO: International Organization for Standardization.

 **CAUTION**

Do not perform the following actions when using DEF as this may cause damage to the BlueTec[®] exhaust gas aftertreatment.

- Do not dilute the DEF.
- Do not mix the DEF with another reagent.
- Do not use DEF that does not conform to ISO 22241.

2 Adding DEF

 **WARNING**

Do not pour anything other than DEF into the DEF tank. Particularly, never pour diesel fuel or gasoline into the DEF tank, because this may cause a fire or damage the BlueTec[®] exhaust gas aftertreatment.

If you accidentally fill the DEF tank with any fluid other than DEF, immediately turn the starter switch to the “LOCK” position, and contact an authorized dealer to have the incorrectly added fluid drained off and the vehicle inspected.

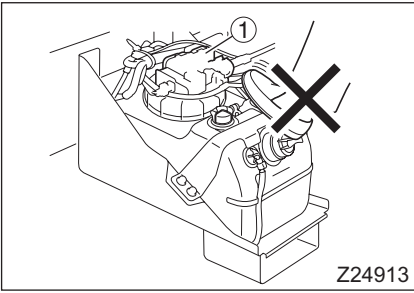

! CAUTION

Do not rest your foot on the DEF tank and the cover, or step on them, because this may damage the tank, cover and/or the sensors ① on the tank.

NOTE:

- Be sure to add DEF well before it is used up. If the DEF tank becomes empty, a driving restriction automatically engages, locking the gear in first or reverse, so the vehicle can be driven only slowly.
- It is recommended that you obtain an additional container of DEF for use in the event that the DEF tank becomes empty.
- You can obtain DEF at any of the following places:
 - Authorized dealer
 - Authorized Parts and Service Center (PSC)
 - Old World Industries distributor
 - Exxon Mobil service station

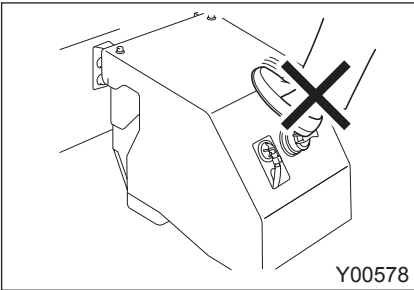

DEF tank capacity	12 liters (3 gallon)
-------------------	----------------------

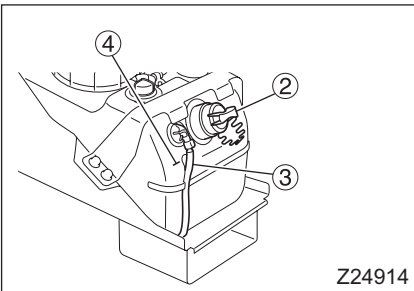

1. Turn the starter switch to the “LOCK” position to stop the engine.
2. Wipe away dirt, mud, or other contamination in the vicinity of the DEF fill cap location.
3. Turn the DEF cap ② counterclockwise and remove it.
4. While observing the level gauge ③, fill the DEF to the FULL line ④ on the tank.

! CAUTION

- Do not use a steel container to hold DEF. DEF reacts with steel and produces a corrosive material. If the tank is refilled with DEF containing this corrosive material, the BlueTec® exhaust gas aftertreatment will be damaged.
- Containers and appliances used to handle DEF must not have been used for other purposes. Impurities that may remain in them could adversely affect the quality of DEF and prevent the engine from starting.

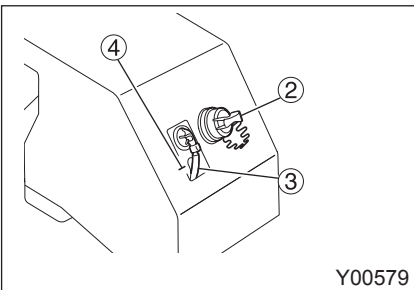

5. Securely install the cap by turning it clockwise.



NOTE:

If DEF is spilled, it should be wiped up completely using a cloth or other suitable material. The area should then be washed with water.

3 Canceling the driving restriction that is engaged when the DEF tank is empty

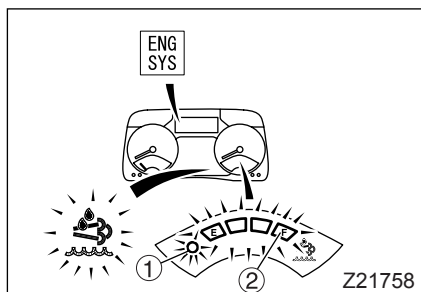
If the DEF tank becomes empty, a driving restriction automatically engages, locking the gear in first or reverse, so the vehicle can be driven only slowly. In the event of a driving restriction, fill the DEF and then disengage the restriction as follows.



1. After refilling the tank with DEF, turn the starter switch from "LOCK" to "ON".
2. Wait until the following changes in state have completed:
 - The  warning lamp, DEF level warning lamp ①, and the  warning extinguish.
 - The DEF level indicator lamp ② stops flashing.
 - The buzzer stops sounding.

Do not turn the starter switch to the "ACC" or "LOCK" position before all the above changes have completed.

NOTE:

- It may take a while after turning the starter switch to the "ON" position before the warning lamp extinguishes and for the buzzer to stop sounding.
- When the DEF tank becomes empty in cold weather, cancel the driving restriction immediately after refilling with DEF. Not canceling the driving restriction and allowing the DEF tank to become frozen may make it difficult to start the engine until the tank thaws out.

4 Storing DEF

Seal the DEF container, and store it indoors in a well-ventilated place away from direct sunlight. The temperature of the storage place should be between -5°C (23°F) and 25°C (77°F).

 **WARNING**

Do not store DEF in a high temperature location.

If the temperature is high, DEF may release ammonia, which is toxic. When storing the container, seal it. Also, open it outdoors in a well-ventilated area. If a pungent odor is emitted from the container, do not carelessly go near it.

NOTE:

- You can use frozen DEF after allowing it to thaw, without loss of quality.
- If you seal the container to prevent the water from evaporating, the quality of the DEF will not change.
- Although DEF is a non-flammable liquid, it may emit a pungent odor if it is heated due to a fire, for example. In the event that a fire breaks out, promptly move the container to a safe place.
- It is strongly recommended to store or carry DEF in the original container in which it was sold. If unavoidable, you can also use a polypropylene tank instead, after thoroughly cleaning the inside with DEF and making sure that it contains absolutely no water or other impurities.

 **CAUTION**

Do not store DEF in a non-specified container. If DEF is stored in a steel container and then introduced into the DEF tank, corrosive material produced by chemical reactions will damage the BlueTec[®] exhaust gas aftertreatment.

- DEF must be handled as industrial waste when discarding it.

 **CAUTION**

Do not discard DEF in a lake or marsh, in the sea, or in a river because this may cause environmental destruction.

RECORDING, STORING, AND HANDLING OF THE VEHICLE DATA

1 Recording and storing of the vehicle data

Vehicles are equipped with multiple computers for recording data about vehicle control and operation. Though the type of data recorded varies according to vehicle specifications, the major types of data recorded by these computers include the following.

- Engine speed
- Operational status of the accelerator pedal
- Operational status of the brake pedal
- Vehicle speed
- Gear position (not applicable for vehicles with manual transmissions)

NOTE:

These computers are different from typical data recorders, and they do not record video or audio, such as conversations.

2 Handling of the recorded vehicle data

Mitsubishi Fuso Truck & Bus Corporation (MFTBC) and third parties commissioned by MFTBC acquire and use the data stored in these computers to diagnose vehicle faults, for research and development, and to improve quality.

MFTBC and the persons commissioned by MFTBC will not disclose or provide the recorded data to third parties except for the case where:

- MFTBC obtains the consent of the owner (the lessee in case of leased vehicles),
- MFTBC is requested by a police, court, government agency or the like with legal force to provide the data, or
- the data is provided to research institutions for the purpose of statistical analysis; provided that such data must be modified in a way that the owner and the vehicle cannot be identified.

REPORTING SAFETY DEFECTS

If you believe that your vehicle has a defect that could cause an accident or could cause injury or death, you should immediately inform both the National Highway Traffic Safety Administration (NHTSA) and Mitsubishi Fuso Truck of America, Inc. (MFTA).

If NHTSA receives similar complaints, it may open an investigation, and if it finds that a safety defect exists in a group of vehicles, it may order a recall and remedy campaign. However, NHTSA cannot become involved in individual problems between you, your dealer, or MFTA.

To contact NHTSA, you may either call the Vehicle Safety Hotline at 1-888-327-4236 (TTY: 1-800-424-9153) or write to: Administrator, U.S. Department of Transportation National Highway Traffic Safety Administration Office of Defects Investigation -NVS-210 1200 New Jersey Ave. SE West Building Washington, DC 20590.

You can also obtain other information about motor vehicle safety from the Vehicle Safety Hotline.

For further information, please visit the following NHTSA website:

<http://www.safercar.gov>

OBTAINING SERVICE

At Mitsubishi Fuso Truck of America, Inc. (MFTA), we are proud of the quality and workmanship that is built into every MFTA Truck. We are equally proud of our corporate commitment to promote the highest possible degree of customer satisfaction with our products and services.

Today's trucks are extremely complex and are comprised of an enormous number of individual parts. Occasionally, a failure of one of these parts may occur. Should you experience such a failure, we are confident that you will find an Authorized Dealer prepared to provide you with high quality service. Every Authorized Dealer has trained personnel, plus the tools and equipment necessary to provide for your various service needs. In the event that a problem arises, we ask you to follow the procedure outlined as follows, and in the sequence listed:

STEP 1: CONTACTING YOUR NEAREST AUTHORIZED DEALER

This is the most direct and expedient way to obtain service. Each Authorized Dealer has the ultimate responsibility for providing the services and repairs you may need. We recommend that you contact the Service Manager of your nearest Authorized Dealer for assistance. In the event that you feel additional assistance is required, ask to speak to the General Manager of the Authorized Dealer.

STEP 2: CONTACTING MFTA

After the completion of Step 1, and in the event that your nearest Authorized Dealer has been unable to satisfactorily resolve the problem, please contact MFTA's Customer Service Representative at **1-877-711-0707**.

Please be prepared to provide the following information when you call:

- Your Name, Company Name, Address, Telephone Number
- Vehicle Model
- Vehicle Model Year
- Vehicle Identification Number
- Mileage
- Name of Dealer contacted under Step 1, if applicable
- Details of the Complaint/Comment

You also may correspond with the Customer Service Representative in writing, addressed to:

**MINITUBISHI FUSO TRUCK OF AMERICA, INC.
CUSTOMER SERVICE REPRESENTATIVE
2015 CENTER SQUARE RD.
LOGAN TOWNSHIP, NJ 08085**

2. WARNING LABELS

INTERIOR LABELS 2-3
EXTERIOR LABELS 2-5

- The caution and warning labels show important information. Be sure to read them before using the vehicle.
- If any label has peeled so it is difficult to read, is scratched or otherwise damaged, or has peeled off completely, please inform an authorized dealer. The warning and caution labels apply only to the vehicle itself, not to any equipment mounted on the vehicle. For information on caution and warning labels that apply to equipment mounted on the vehicle, please refer to the Owner's Manual supplied by the manufacturer of the equipment.
- The locations of these labels and the information on them may vary with the vehicle model. Check the information on each label on your vehicle.

INTERIOR LABELS

1 Near the driver's seat

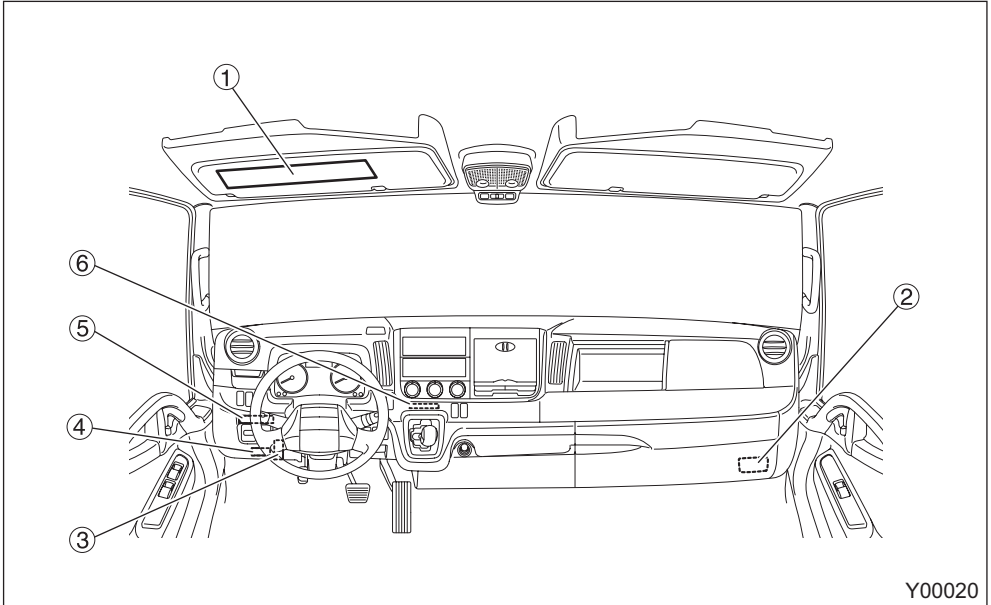

Location	Category	Information	Ref. page
①	⚠ WARNING	High temperatures of exhaust system components	5-52
	⚠ WARNING	Handling of DPF system with regeneration control	5-52
	⚠ WARNING	Handling of DEF	1-8
②	⚠ WARNING	Use of specified fuses	13-10
③	⚠ WARNING	Engine oil level check	12-22
④	⚠ WARNING	Fuel to use	1-5
⑤	⚠ WARNING	DPF indicator lamp	5-52
⑥	⚠ WARNING	How to drive on downhill roads *1	7-12

*1: This label may not be installed on your vehicle.

2 Driver's door and door pillar

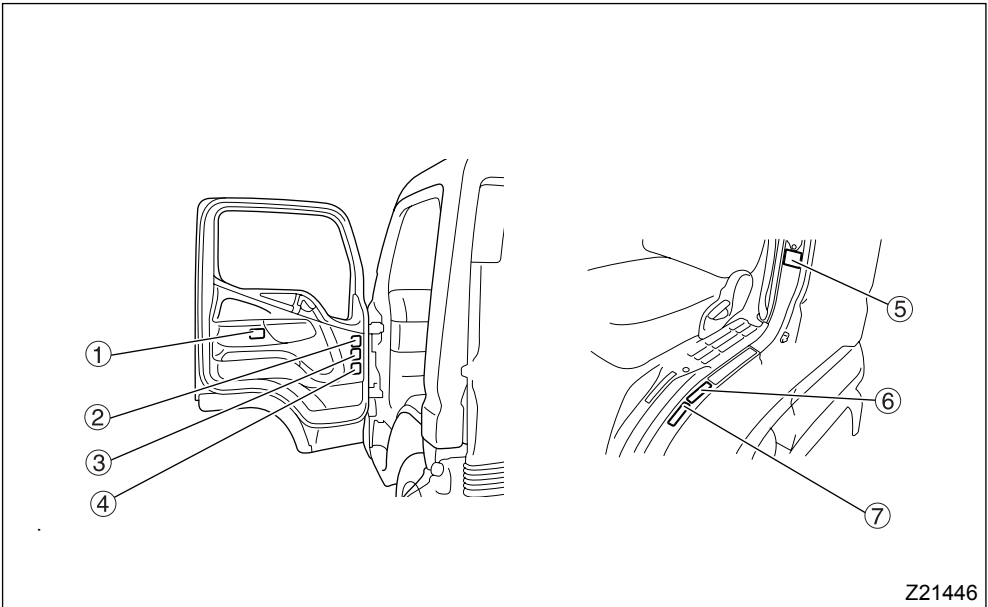

Location	Category	Information	Ref. page
①	⚠ CAUTION	Handling of PTO *1	5-47
②	⚠ WARNING	Handling of DUONIC®	5-21
③	⚠ WARNING	4WD <FG>	8-1
④	⚠ CAUTION	Towing precautions	13-32
⑤	Standard value	Tire pressure	12-72
⑥	⚠ WARNING	113-liter fuel tank refilling precaution	1-5
⑦	⚠ WARNING	Precautions for vehicles with limited slip differential *1, 2	12-75

*1: If equipped

*2: Standard on FG

EXTERIOR LABELS

1 On frame and exterior equipment

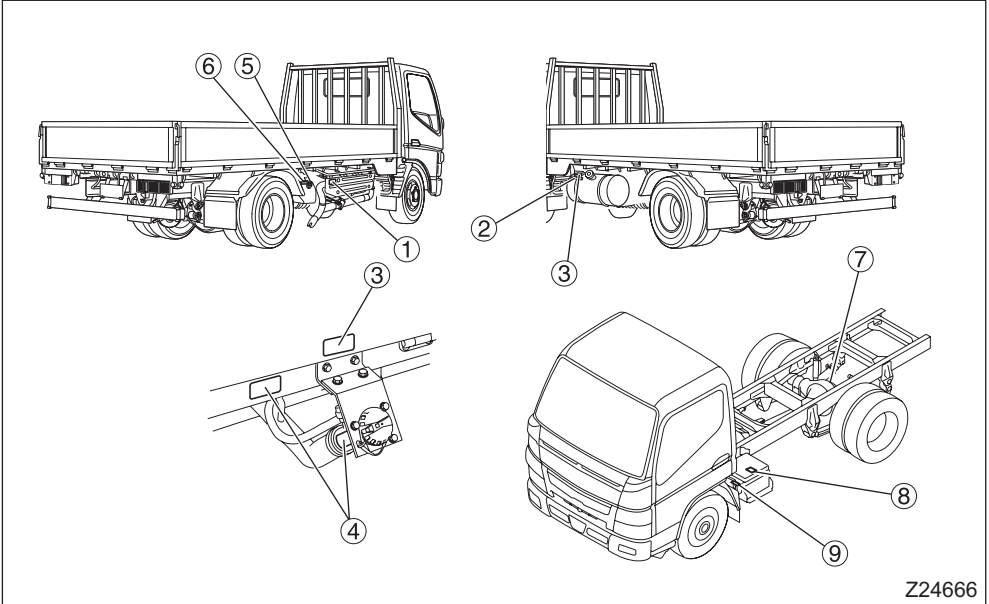

Location	Category	Information	Ref. page
①	⚠ DANGER	High temperatures of the exhaust system components	5-52
②	⚠ CAUTION	Use of diesel fuel	1-5
③	⚠ WARNING	Fuel selection	1-5
④	⚠ WARNING	113-liter fuel tank filling precautions	1-5
⑤	⚠ CAUTION	Prohibition against standing on the DEF tank	1-8
⑥	⚠ CAUTION	Use of DEF	1-8
⑦	⚠ CAUTION	Oil specification for limited slip differential*	12-35
⑧	⚠ DANGER	Battery handling precautions	12-90
⑨	⚠ WARNING	Fuse information and location	13-10

*: If equipped

2 On cab outside and engine

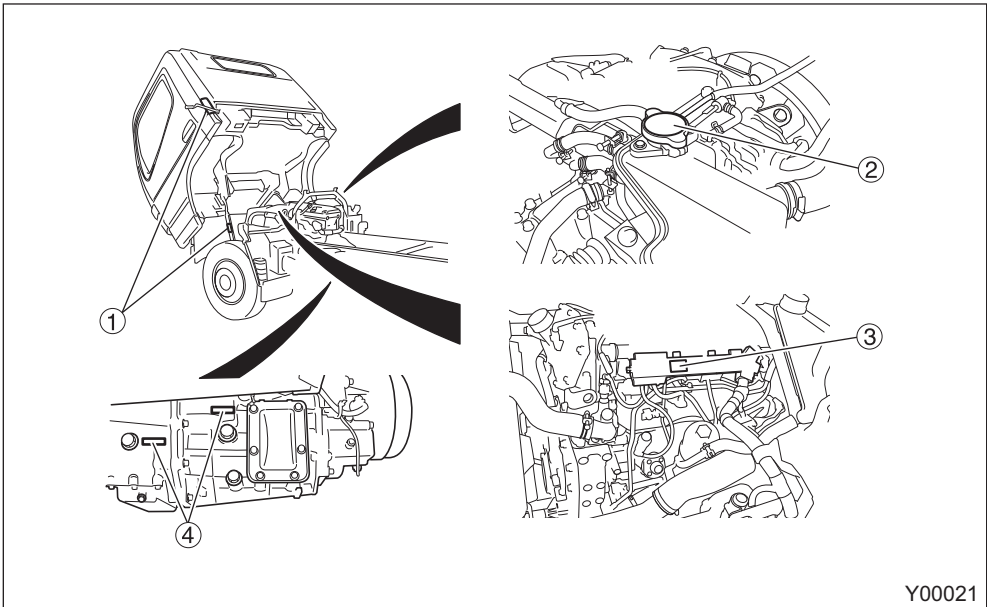

Location	Category	Information	Ref. page
①	⚠ WARNING	Handling of cab tilt function (Vehicles other than Crew-cab models)	12-6
②	⚠ WARNING	Handling of the pressure cap	12-62
③	⚠ CAUTION	Inspection and replacement of engine oil	12-22
④	⚠ CAUTION	Oil specification for clutch and transmission	12-30

3. OPENING AND CLOSING

STARTER KEY * 3-2

ENGINE IMMOBILIZER STARTER KEY * 3-3

DOORS 3-6

CENTRAL DOOR LOCKS 3-8

KEYLESS ENTRY SYSTEM 3-9

ENTERING AND EXITING THE VEHICLE 3-13

DOOR WINDOW GLASS 3-15

*: If equipped

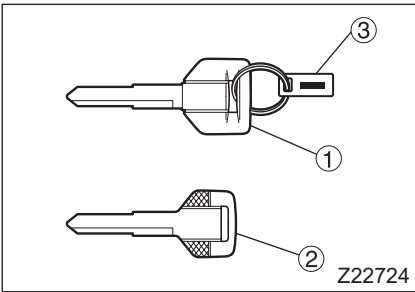
STARTER KEY *

Supplied keys

- ① Main starter key
- ② Sub starter key
- ③ Key number plate

Your vehicle comes with two keys, the main starter key ① and a sub starter key ②, however either of these keys can be used to lock and unlock the doors, and start and stop the engine.

NOTE:

Keep the key number plate ③ in a safe place. If you have lost your keys, you can purchase new keys by informing an authorized dealer of this key number.

ENGINE IMMOBILIZER STARTER KEY *

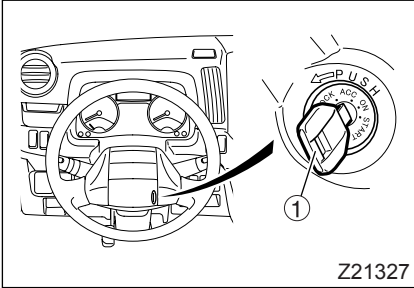

1 Engine immobilizer

- The engine immobilizer is a theft prevention device. It prevents the engine from being started unless an engine immobilizer starter key ① that has been registered to it is used.
- The engine immobilizer automatically starts operating as soon as the starter switch is turned to “ACC” or “LOCK”. Once the engine immobilizer is activated, it prevents the engine from being started.
- The engine immobilizer starter key sends a signal to the vehicle, thereby canceling the engine immobilizer such that the engine can be started.

NOTE:

The immobilizer complies with part 15 of the FCC Rules. Operation is subject to the following two conditions:

- (1) The immobilizer may not cause harmful interference.
- (2) The immobilizer must accept any interference received, including interference that may cause undesired operation.

Changes or modifications not expressly approved by the party responsible for compliance could void the user's authority to operate the equipment.

2 Supplied keys

- ① Engine immobilizer starter key
- ② Key number plate

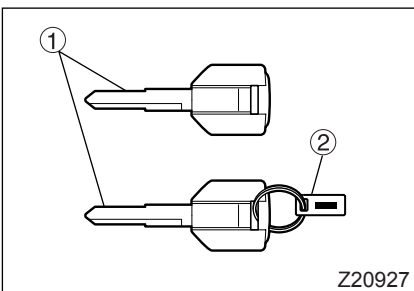

The engine immobilizer starter key ① incorporates an engine immobilizer function (theft prevention device).

NOTE:

Keep the key number plate ② in a safe place. If you have lost your keys, you can purchase new keys by informing an authorized dealer of this key number.

3 Using the engine immobilizer starter key

In the circumstances detailed below, it is possible that the vehicle cannot receive a signal from the immobilizer starter key, meaning that the engine cannot be started, even if the starter switch is turned to the "START" position. If this happens, remove any keys and other metallic objects that are touching the immobilizer starter key, return the starter switch to the "ACC" or "LOCK" position, and try starting the engine again.

If you still cannot start the engine, have the vehicle inspected at an authorized dealer.

- A metallic ring is on top of the handle of the engine immobilizer starter key.

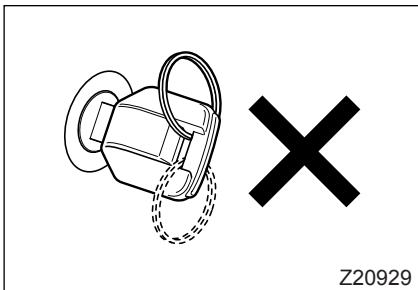

- The handle of the engine immobilizer starter key is in contact with a metallic part of another key.

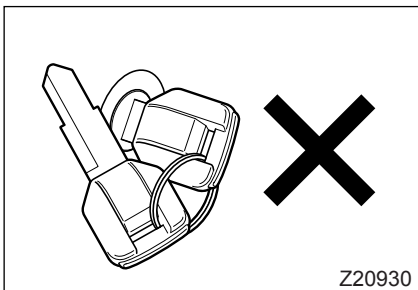

- The engine immobilizer starter key is placed on top of or near to another vehicle's engine immobilizer starter key.
- A key holder that emits radio frequency waves or the remote control switch of the keyless entry system is placed on top of or near the engine immobilizer starter key.
- A card with an embedded IC chip or a mobile phone is held together with the engine immobilizer starter key.

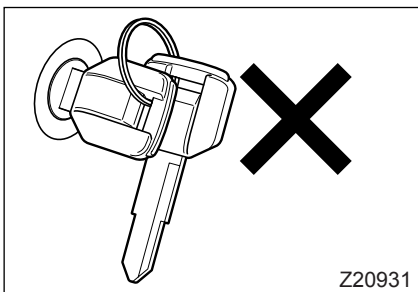

The engine immobilizer starter key is an electronic device containing a signal transmitter. Keep in mind the following cautions:

- Do not bend the engine immobilizer starter key or subject it to strong shocks.
- Do not leave the engine immobilizer starter key in any part of the cab where it could be exposed to direct sunlight and get extremely hot (60°C (140°F) or higher).
- Do not store the engine immobilizer starter key near a magnet or any other source of magnetism.
- Do not disassemble or modify the engine immobilizer starter key.
- Keep magnetic keyrings and other magnetic items away from the engine immobilizer starter key.
- Do not place the engine immobilizer starter key near an audio player, personal computer, television set, or other device that is a source of magnetism.
- Do not clean the engine immobilizer starter key using an ultrasonic cleaner.

In the event that you lose an engine immobilizer starter key or wish to have a new one made, contact an authorized dealer. (A maximum of six engine immobilizer starter keys can be registered with a single vehicle.) You will need to take to the authorized dealer all the engine immobilizer starter keys that you have at the time.

Please note the following regarding registration of starter keys:

- When having the registration of a starter key deleted by an authorized dealer, also take to the dealer all the starter keys for which you do not wish to delete the registration.
- If you lose all of the starter keys, additional registration or deletion of registration of starter keys is not possible, and you must then purchase a new immobilizer control unit and a new starter key.

DOORS **WARNING**

- To help prevent accidents, always check for vehicles and pedestrians approaching from behind before opening the doors.
- Make sure the doors are completely closed before starting. Driving with a door ajar could cause the door to suddenly fall open.
- Exercise caution when opening a door in strong wind. Otherwise, the wind could catch the door and suddenly blow it open.
- Exercise caution when opening a door on a downward slope. Otherwise, the inclination of the vehicle could cause the door to suddenly fall open.
- When leaving the vehicle, take with you any children or pets who were riding in the cab. Never leave children or pets in the cab. A child left in the cab could interfere with the vehicle, causing it to move or catch fire. Also, the cab gets extremely hot in sunshine and in hot weather so a child left in the cab could suffer heatstroke.
- When closing a door, be careful not to trap your hand or anything else.

 **CAUTION**

- Only open or close a door slowly without applying undue force; otherwise the door components could be damaged.
- Do not swing on or hang anything heavy on any of the doors. Doing so could damage the door components.

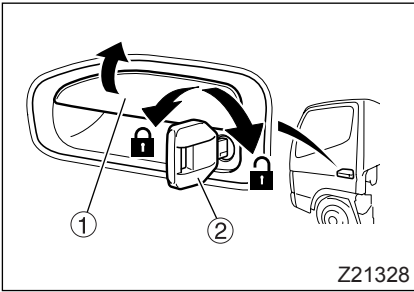

1 From outside the vehicle

- To open, pull the outer handle ① toward you.
- Use the starter key ② to lock or unlock the door.
- It is possible to lock each door without using the starter key. With the driver's door or assistant driver's door, push the lock knob ③ toward the front of the vehicle then pull the outer handle and keep it pulled as you close the door. With a rear door, push the lock knob ④ down then pull the outer handle and keep it pulled as you close the door.

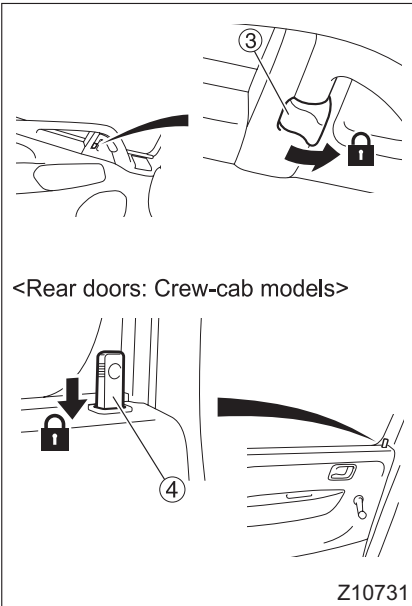

NOTE:

- *Locking the driver's door using the starter key or lock knob also causes the assistant driver's door and the rear doors (Crew-cab model vehicles) to automatically lock.*
On the other hand, unlocking the driver's door using the starter key or lock knob unlocks only the driver's door.
- *When you leave your vehicle, stop the engine and lock the doors to prevent theft.*
- *When you lock the vehicle without using the starter key, make sure that you are carrying the key before you lock it.*
- *In models with the keyless entry system, you will not be able to lock the driver's side door with the lock knob while the starter key is inserted in the starter switch. Lock the door after removing the starter key.*

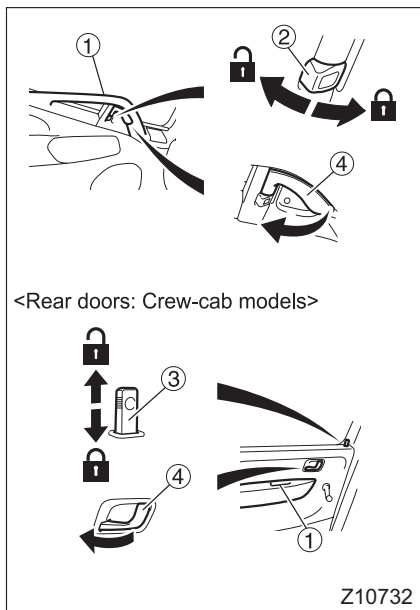

2 From inside the vehicle

- To close, use the door waist bar ①. Close the door completely.
- To lock the driver's door or assistant driver's door, push the lock knob ② toward the front of the vehicle. To lock a rear door, push the lock knob ③ down.
- To unlock and open the driver's door or assistant driver's door, push the lock knob toward the rear of the vehicle then pull the inner handle ④. To unlock and open a rear door, pull up the lock knob then pull the inner handle ④.





CAUTION

Closing the door by pulling any part other than the door waist bar could damage the door mechanism.

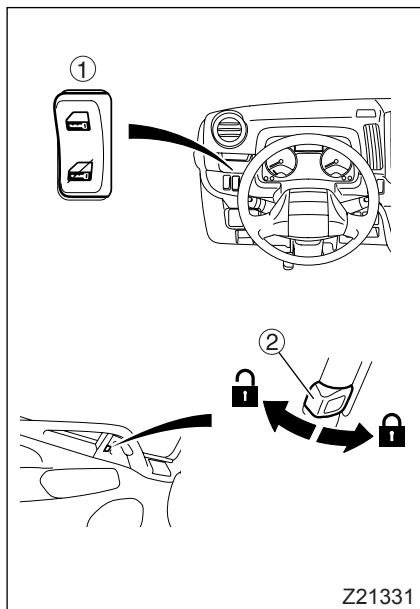
CENTRAL DOOR LOCKS



- When the  side of the switch ① is pressed, all doors are locked. When the  side of the switch is pressed, all doors are unlocked.
- When the lock knob ② on the driver's door is pushed forward, the assistant driver's door and the rear doors (Crew-cab model vehicles) are also automatically locked. If the lock knob on any door is subsequently pushed rearward, only that door is unlocked.
- When the driver's door is locked from outside using the starter key, the assistant driver's door and the rear doors (Crew-cab model vehicles) are also automatically locked. If the starter key is subsequently used to unlock any door, all the doors except that door remain locked.

KEYLESS ENTRY SYSTEM

1 The Grant of Equipment Authorization certificate for wireless transmitter (remote control switch)

TCB	<p>GRANT OF EQUIPMENT AUTHORIZATION</p> <p>Certification Issued Under the Authority of the Federal Communications Commission</p> <p>By:</p> <p>Underwriters Laboratories, Inc.-Northbrook 333 Pflugsten Road Northbrook, IL 60062</p>	TCB								
<p>U-shin Ltd 5217, Nakaze, Hamamatsu-shi Shizuoka-ken, 434-0012 Japan</p> <p>Attention: Satoru Gokuda , Acting Executive Manager design Dept.2</p>	<p>Date of Grant: 06/14/2010 Application Dated: 06/14/2010</p>									
<p>NOT TRANSFERABLE</p> <p>EQUIPMENT AUTHORIZATION is hereby issued to the named GRANTEE, and is VALID ONLY for the equipment identified hereon for use under the Commission's Rules and Regulations listed below.</p>										
<p>FCC IDENTIFIER: OBIH7079TX</p> <p>Name of Grantee: U-shin Ltd</p> <p>Equipment Class: Part 15 Remote Control/Security Device Transceiver</p> <p>Notes: Transmitter, Keyless Entry</p>										
<p><u>Grant Notes</u></p>	<p><u>FCC Rule Parts</u> 15.231</p>	<table border="0" style="width: 100%;"> <tr> <td style="text-align: center;"><u>Frequency Range (MHZ)</u></td> <td style="text-align: center;"><u>Output Watts</u></td> <td style="text-align: center;"><u>Frequency Tolerance</u></td> <td style="text-align: center;"><u>Emission Designator</u></td> </tr> <tr> <td style="text-align: center;">315.0 - 315.0</td> <td></td> <td></td> <td></td> </tr> </table>	<u>Frequency Range (MHZ)</u>	<u>Output Watts</u>	<u>Frequency Tolerance</u>	<u>Emission Designator</u>	315.0 - 315.0			
<u>Frequency Range (MHZ)</u>	<u>Output Watts</u>	<u>Frequency Tolerance</u>	<u>Emission Designator</u>							
315.0 - 315.0										



1. FCC ID: OBIH7079TX
2. This device complies with Part 15 of the FCC Rules. Operation is subject to the following two conditions:
 - This device may not cause harmful interference.
 - This device must accept any interference received, including interference that may cause undesired operation.
3. Changes or modifications not expressly approved by the party responsible for compliance could void the user's authority to operate the equipment.

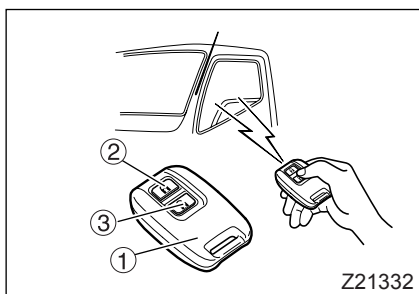

2 Keyless entry system

The keyless entry system allows you to lock/unlock the driver's door, assistant driver's door and rear doors (Crew-cab model vehicles) by operating the remote control switch ①.



⚠ WARNING

If you carry the keyless entry remote control switch with you when traveling on an airplane, avoid pressing any button on the switch. If you keep the switch in a suit pocket or somewhere like a bag, prevent the switch buttons from being accidentally pressed, since the radio-wave signals emitted from the switch could interfere with normal operation of the airplane.

⚠ CAUTION

- Do not expose the remote control switch to water, disassemble it, or apply shock by dropping it.
- Do not leave the remote control switch in a place that is exposed to direct sunlight or where the temperature rises to 60°C/140°F or above. Doing so will shorten the life or cause failure of the remote control switch.
- Do not remove the cover from the remote control switch unless you replace the battery. Removing it for no reason could lead to a remote control switch malfunction.

3 Operating the remote control switch

- Point the remote control switch toward the center of the cabin.
- Operate the remote control switch within 3 m (9.8 ft.) from the center of the cabin.
- Press the  button ② to lock all doors.
- Press the  button ③ once to unlock the driver's door. You can unlock the assistant driver's door and rear doors (Crew-cab model vehicles) if you press the  button one more time within 5 seconds.

NOTE:

The assistant driver's door and rear doors (Crew-cab model vehicles) do not unlock if you press the  button ③ more than 5 seconds after unlocking the driver's door.

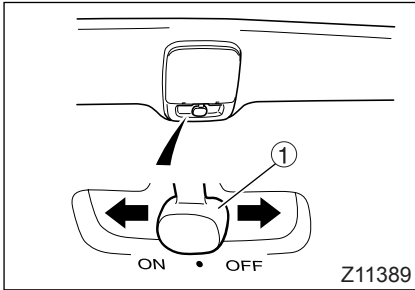

- When you press the buttons, be sure to press them for at least one second. If a button does not work after one press, press the button again after one or two seconds.
- After locking the doors with the remote control switch, always check that the doors are locked by lifting the outside handle of a door.
- You can check the locking/unlocking of the doors by the flashing of the hazard lamps and the room lamp. Leave the room lamp switch ① “•” (in the center “•” position).
When the doors are locked, the room lamp and the hazard lamps flash twice.
When the doors are unlocked, the hazard lamps flash once and the room lamp lights up for approximately 10 seconds.
- If you do not open a door within 30 seconds after unlocking with the remote control switch, the doors will automatically be locked again.

NOTE:

- *The range in which you can operate the remote control varies depending on the surroundings, such as proximity to a TV tower, power station, broadcasting station, etc.*
- *If you lose the remote control switch or the switch does not work, please contact an authorized dealer. The dealer will produce two new spare remote control switches for you.*

The remote control switch does not work under the following conditions:

- *Any door is not fully closed.*
- *The starter key is in the starter switch.*

4 Replacing the remote control switch battery

The battery may be inefficient if the remote control switch does not lock or unlock the doors upon pressing the corresponding button. Replacing the battery will solve the problem.



WARNING

- **Keep the batteries out of the reach of children. If a child swallows a battery, visit a doctor immediately.**
- **Do not disassemble, heat or drop the battery in water. Doing so could cause a fire or explosion.**

⚠ CAUTION

- Use the designated standard type of battery. If the battery is replaced with an incorrect type, the battery could explode.
- Attach the battery with the “+” mark facing upward.
- Do not use a metal tool such as tweezers to replace the battery. Doing so could cause a short circuit.
- Dispose of used batteries in accordance with local regulations. Inconsiderate disposal could adversely affect the environment. For disposal, wrap the battery with tape, vinyl sheet, etc. for insulation so that the battery cannot contact other metal objects or be exposed to water.
- Do not expose the inside of the remote control switch to water, and keep it away from dirt and dust. Otherwise, the switch could fail.

Recommended replacement battery	Quantity
Lithium battery CR2032	1

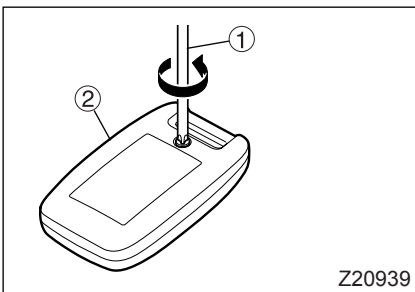

1. Using a Phillips-head screwdriver ①, turn the screw and remove the cover ②.

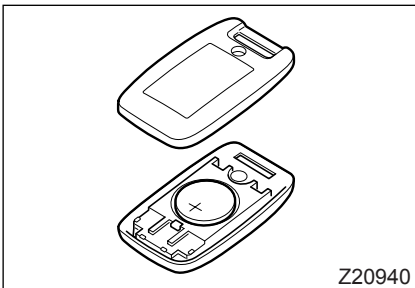

2. Replace the battery. Place a new battery with the “+” mark facing upward.
3. Reattach the cover and the screw.
4. Operate the switch and check that the remote control works.

ENTERING AND EXITING THE VEHICLE**WARNING**

- Always use the step to climb into or down from the vehicle. Never put your foot on the wheel or tire since it could easily slip off.
- The step can become slippery in rain or snow. Firmly hold the grip while climbing into or down from the vehicle. Holding the grip is particularly important when snow has settled and frozen on the step.
- If your hand or the soles of your shoes are oily or greasy, you could slip when climbing down from the vehicle.
Wipe any oil and grease off the soles of your shoes before entering or leaving the vehicle.
- Do not jump down from the vehicle. Jumping down from the vehicle could cause you to fall or sustain an injury. Always use the step and hold the grip to climb into or down from the vehicle.
- Take care when entering or exiting the vehicle on a slope or in a strong wind since the door could open or close suddenly.

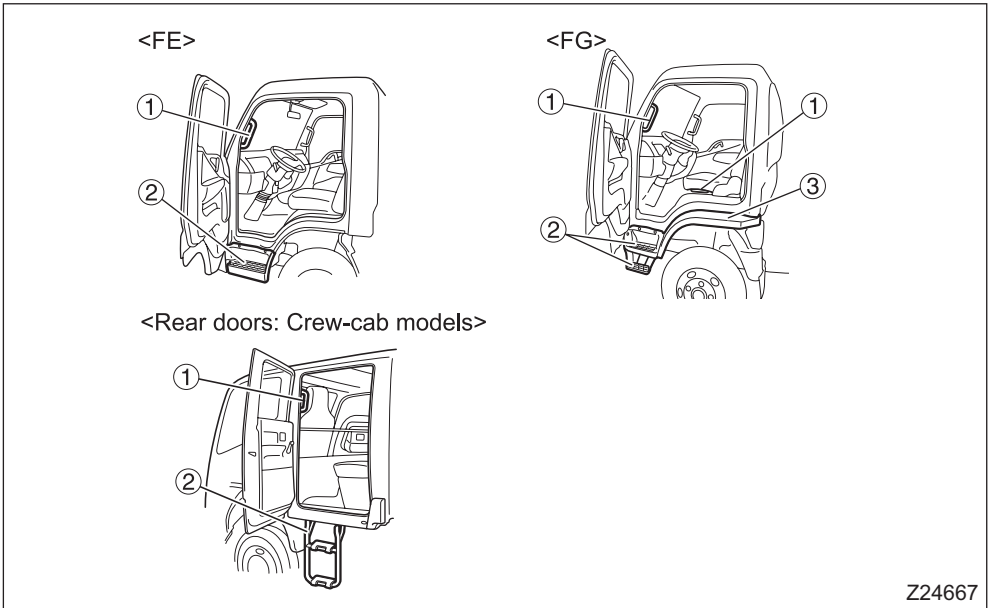

Z24667

! CAUTION

- Climb into and out of the cab by holding only the grip. If you hold onto any other parts of the vehicle, they could break or fail.
- When entering or leaving an FG model truck, do not place your feet or hands on the fender ③. The fender could suffer damage. Also, the fender can be dangerously slippery.

When climbing into and out of the cab, support your body by at least three points at a time by firmly gripping the handle ① and fully placing your feet on the steps ②.

DOOR WINDOW GLASS

WARNING

Do not put your hands or face out of the window while driving. Doing so could cause you to hit an object outside the vehicle, or become seriously injured in the event of sudden braking. Be extra careful with children.

1 Power window switches

WARNING

When closing the power windows, be careful not to trap your hands, neck or other body parts. Doing so could cause serious injury if a body part is trapped by the window glass. Be extra careful with children. Only adults should open or close the power windows - never allow children to operate them.

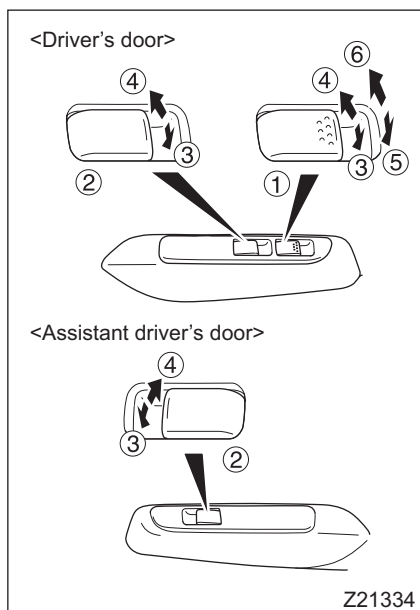

The power window switches function only when the starter switch is in the "ON" position.

① For the driver's door window

② For the assistant driver's door window

The switch for the driver's door window has an auto function for fully opening or fully closing the window with a single touch of the switch.

- Manual operation
 - Gently press the switch ③ to open the window. The window will move only while you are pressing the switch. It will stop when you release the switch.
 - Gently pull the switch ④ to close the window. The window will move only while you are pulling the switch. It will stop when you release the switch.
- Automatic operation
 - Press the switch firmly ⑤ to fully open the driver's door window with a single touch of the switch. If you wish to stop the window part-way, give the switch a gentle pull.
 - Pull the switch firmly ⑥ to fully close the driver's door window with a single touch of the switch. If you wish to stop the window part-way, give the switch a gentle push.

⚠ CAUTION

Do not keep any door or window open in rainy weather, and be careful not to spill a drink on any of the window switches. If water or any other liquid gets on a window switch, it can cause a malfunction.

NOTE:

In cold weather, the auto function may not work temporarily. In this event, keep pushing or pulling the switch to fully open or close the window.

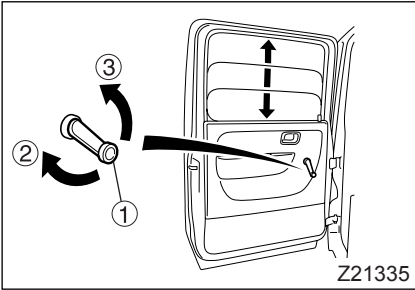
**2 Window regulator handle
<Crew-cab models>**

Turn the window regulator handle ① to open or close the window.

- ② Open
- ③ Close

4. SEAT AND STEERING WHEEL ADJUSTMENTS

SEATS 4-2
SEAT BELTS 4-5
STEERING WHEEL 4-9

SEATS

! WARNING

- Adjusting the seat while the vehicle is in motion is dangerous as the seat may move more than you intend. Be sure to stop the vehicle and set the parking brake before performing any adjustment of the seat.
- After you have adjusted the seat, gently move or rock the seat to ensure that it is locked in the desired position.
- When adjusting the seat, keep your hands away from the bottom of the seat and from moving parts of the seat. Otherwise, you could suffer an injury by getting your hands and fingers trapped.
- When adjusting the angle of the seatback, keep your back or hand pressed against it. Otherwise, the seatback could suddenly return to its original position and injure you by hitting your face or other body parts.

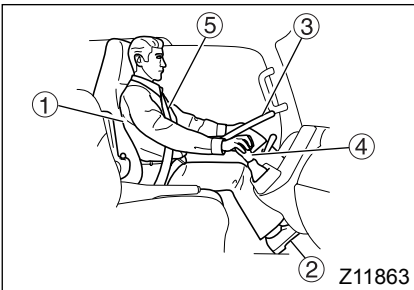
**1 Driver's seat****1.1 Correct driving position**

- Before driving the vehicle, adjust the seat with reference to the following points:
 - ① Your back must touch the seatback, and you must be able to see the warning lamps and gauges.
 - ② You must be able to reach and firmly press the pedals.
 - ③ You must be able to operate the steering wheel and switches with ease.
 - ④ You must be able to operate the shift lever with ease.
 - ⑤ You must be able to fasten the seat belt correctly.
- Adjust the steering wheel to a position at which you can operate it comfortably with your arms slightly bent.

! WARNING

Adjust the seat and steering wheel so that you are in the correct driving position. Driving in an incorrect driving position could lead to a severe accident.

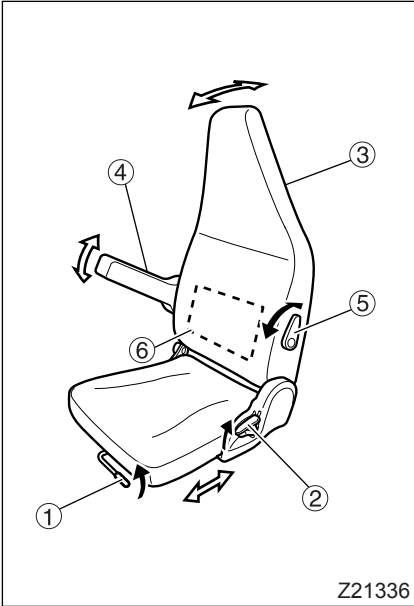

1.2 Making adjustments

- ① Slide adjustment lever
Slide seat forward or backward while holding slide adjustment lever up. After making the adjustment, release the lever and move the seat back and forth slightly to lock it in position.
- ② Reclining lever
Raise reclining lever to adjust the angle of the seatback.
- ③ Seatback
Raise reclining lever to adjust the angle of the seatback.
- ④ Armrest
Lower the armrest to use it.

! WARNING

Do not climb on or sit on the armrest. Doing so could damage the armrest or cause injury.

- ⑤ Lumbar support lever
Pull the lever to adjust the lumbar support in the seatback as desired.

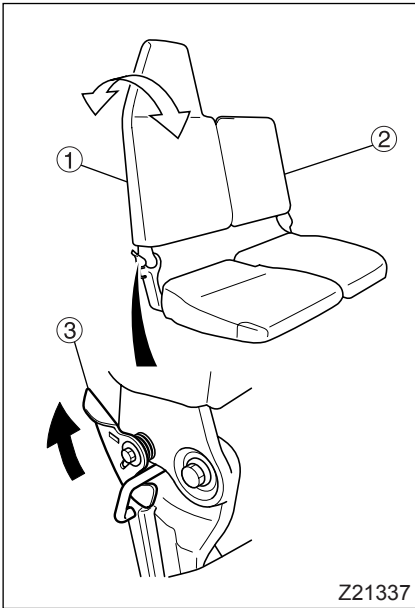

Z21337

2 Assistant driver's seat

- ① Assistant driver's seat
- ② Center seat

It is possible to tip the seatback fully forward. With the lever ③ pulled, grasp the seatback at the top and tip it forward.

After returning the seatback to its original position, gently rock it to make sure it is locked in place.

NOTE:

If the lever ③ is difficult to move, pull it while pushing the top of the seatback rearward. Then you will be able to pull the lever easily.

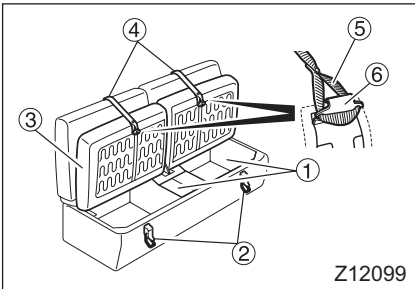

Z12099

3 Rear seat – Crew-cab models

Storage compartments ① are located under the rear seat. The rear seat can be folded up for access to them. When you wish to stow or remove something from these compartments, release the clamps ② at the base of the seat and raise the seat cushion ③. To retain the seat cushion, use the retaining bands ④ that are attached to the seatback. Fit the loop ⑤ at the end of each retaining band over the corresponding hook ⑥ on the seat cushion.

After using this storage, return the rear seat to the original position and lock it by fully fastening the clamps.



SEAT BELTS

- To help prevent injury in the event of a sudden stop or accident, all vehicle occupants must wear their seat belts correctly.
- When wearing your seat belt, sit back in your seat with your back straight. If a seat belt is used incorrectly, its effectiveness is greatly diminished and it could aggravate injuries in the event of an accident.
- For details of seat belt usage for children and pregnant women, refer to “Infants and child restraints” and to “Pregnant women”. ⇨ P. 4-8

WARNING

- **Passengers must never be in the cargo area while the vehicle is in motion. Unless seated and properly belted up, the risk of injury is greatly increased.**
 - **Seat belts should be worn as low as possible over the hips. Wearing a seat belt across the abdomen could be dangerous since undue pressure would be placed on internal organs in the event of a collision.**
 - **Make sure that the seat belt is not twisted when fastening it. A twisted seat belt could be dangerous since its reduced width will apply a larger force to a smaller part of your body in the event of impact.**
 - **Replace any seat belt that is cut or frayed, or if its buckle does not work properly.**
 - **Never use a single seat belt for more than one person.**
 - **It is dangerous to fasten or unfasten your seat belt while driving since the momentary diversion of your attention could lead to a serious accident. Always stop the vehicle first.**
- The driver's seat and the assistant driver's seat feature 3-point lap and shoulder belts with Emergency Locking Retractor (ELR), while the middle seat features a 2-point lap belt.

1 Lap and shoulder belts with ELR

NOTE:

It is not necessary to adjust the length of these seat belts.

An ELR seat belt extends and retracts automatically as its wearer moves but locks automatically for protection in the event of a sudden stop or shock.

The belt's tightness should be adjusted automatically. If there is any looseness, lift the shoulder belt gently and the mechanism will take up the slack. With the belt properly tightened, the risk of it slipping off in a collision is reduced.

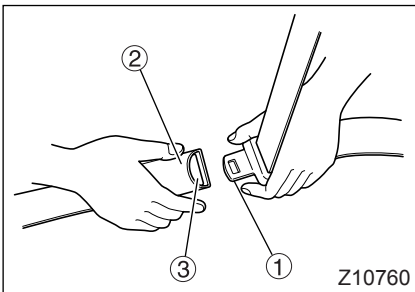

• Fastening

1. Sit back in your seat with your back straight.
2. Hold tang ① and gently extend the belt. If the belt locks or is difficult to extend, let it retract and pull it gently again.
3. Take care that the belt does not become twisted. Insert the tang into the buckle ② until you hear a click.

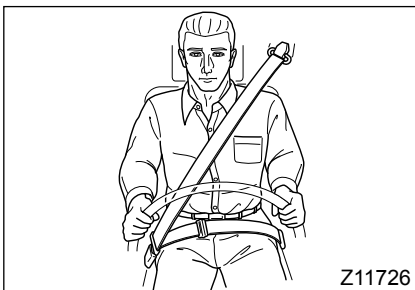

4. Pull on the tang to confirm that it is locked in.
5. Adjust the belt so it is across your hips and shoulder.

• Unfastening

1. Press the red button ③ to unlock the buckle.
2. The belt automatically retracts when unlocked. To prevent the tang causing damage or injury, hold it while the belt retracts.

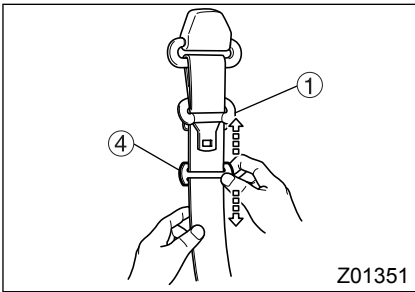
**NOTE:**

The 3-point lap and shoulder belts with ELR come with a tang stopper (4) to prevent the tang (1) from sliding down. Adjust the tang stopper position so that the tang is easy to grasp.

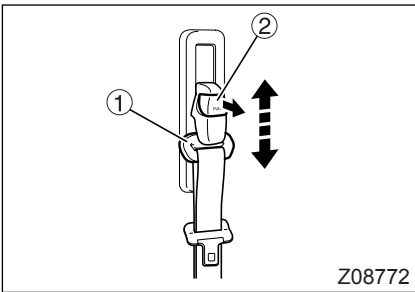
**1.1 Seat belt anchor**

<Driver's seat>

 **WARNING**

The shoulder belt can be dangerous if worn across the neck. Adjust its position so that it does not cross over the neck.

Adjust the seat belt anchor (1) upward or downward to ensure that the belt passes across your shoulder. You will need to keep the lock button (2) pulled while moving the seat belt anchor downward. When the seat belt anchor has reached the desired position, release the lock button and jiggle the seat belt anchor up and down to make sure it is locked in place.

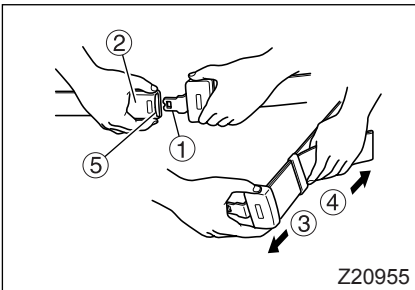
**2 Lap belt****• Fastening**

1. Sit back in your seat with your back straight.
2. Take care that the belt does not become twisted. Insert the tang (1) into the buckle (2) until you hear a click.
3. Pull on the tang to confirm that it is locked in.
4. Adjust the belt so it is low across your hips.
5. To adjust the belt's length, hold the tang at 90° to the belt. Pull the belt end to shorten the belt or the tang to lengthen it.

(3) To lengthen

(4) To shorten

 **WARNING**

For maximum protection in the event of an accident, the belt must not be loose. A loose belt could even aggravate injuries.

- **Unfastening**

1. Press the red button ⑤ to unlock the buckle.
2. When the belt is not in use, insert its tang into the buckle.

3 Infants and child restraints

- When carrying infants or children, they must be restrained properly to minimize the risk of injury in the event of a sudden stop or accident. Never allow infants or children to stand or kneel on the seats. For maximum safety, we recommend fitting and using a restraint system that complies with Federal Motor Vehicle Safety Standards. The use of infant and/or child restraint systems is mandatory in some states. Please abide by your state's regulations.
- Older children may sit on the regular seats and use the regular seat belts. However, make sure that the shoulder belts do not cross their necks or faces.

4 Pregnant women

Since a seat belt could exert undue pressure on the abdomen in the event of an accident, pregnant women should consult a doctor about the use of seat belts before riding in the vehicle.

A pregnant woman should wear her seat belt as low as possible across the hips, not across her abdomen.

5 Seat belt care

- Periodically, check the functionality of the mechanical parts such as the buckles, tangs, and emergency locking retractor (ELR) units. Also check for any damage that could stop the seat belts from functioning properly. Replace the seat belt unit if there is any malfunction or damage.
- Replace any webbing that is cut, frayed, or otherwise damaged. Webbing is the part of the seat belt in contact with the passenger that receives and softens the shock of an impact.
- Replace any seat belt that has been subjected to shock (in a collision, for example) even if it appears normal. If any seat belt is subjected to any shock, however light, have it inspected by an authorized dealer.
- Keep sharp or other potentially damaging objects away from the seat belts, especially the webbing.

- Keep the seat belts clean and dry. Use a mild soap and lukewarm water to clean seat belts. Solvents such as gasoline and thinner may seriously affect the strength of the webbing.
⇒  P. 12-100
- Never attempt to bleach or dye the seat belts, as this could weaken them considerably.
- Do not attempt to remove the seat belts or disassemble the ELR units.

STEERING WHEEL

WARNING

- After every adjustment, try to move the steering wheel back and forth to make sure that it is securely locked. Unless the lever returns to its original position, the steering wheel may move while the vehicle is in motion and cause an accident.
- Make adjustments with the vehicle stationary. Adjusting the steering wheel while driving is dangerous since it could detract from your concentration or cause the steering wheel to move more than desired.

The steering wheel can be adjusted to the preferred height and tilted forward/backward. Adjust the steering wheel as well as the seat to the best positions for easy and safe driving.

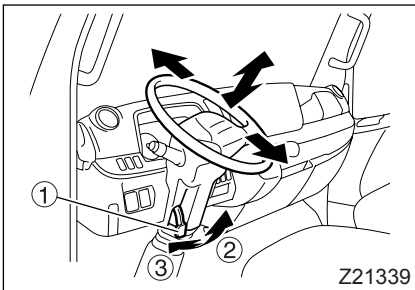

- Pull the lock lever ① then adjust the steering wheel to the height and angle that are most comfortable for you.
 - Push the lock lever back in to securely retain the steering wheel.
- ② Adjust
③ Retain

5. SWITCHES AND CONTROLS

LOCATION OF SWITCHES AND CONTROLS	5-2
STARTER SWITCH	5-3
STARTING THE ENGINE	5-5
WARMING UP THE ENGINE	5-10
STOPPING THE ENGINE	5-12
PEDALS	5-14
PARKING BRAKE LEVER	5-15
COMBINATION SWITCH	5-16
DUONIC®	5-21
CRUISE CONTROL	5-38
HAZARD WARNING LAMP SWITCH	5-44
FRONT FOG LAMP SWITCH *	5-45
VAN BODY DOME LIGHT SWITCH	5-45
REARVIEW MIRRORS	5-45
HEATED MIRROR SWITCH *	5-46
HORN SWITCH	5-47
TRANSMISSION PTO *	5-47
BlueTec® SYSTEM	5-50
IDLE LIMITING SYSTEM *	5-67

*: If equipped

LOCATION OF SWITCHES AND CONTROLS

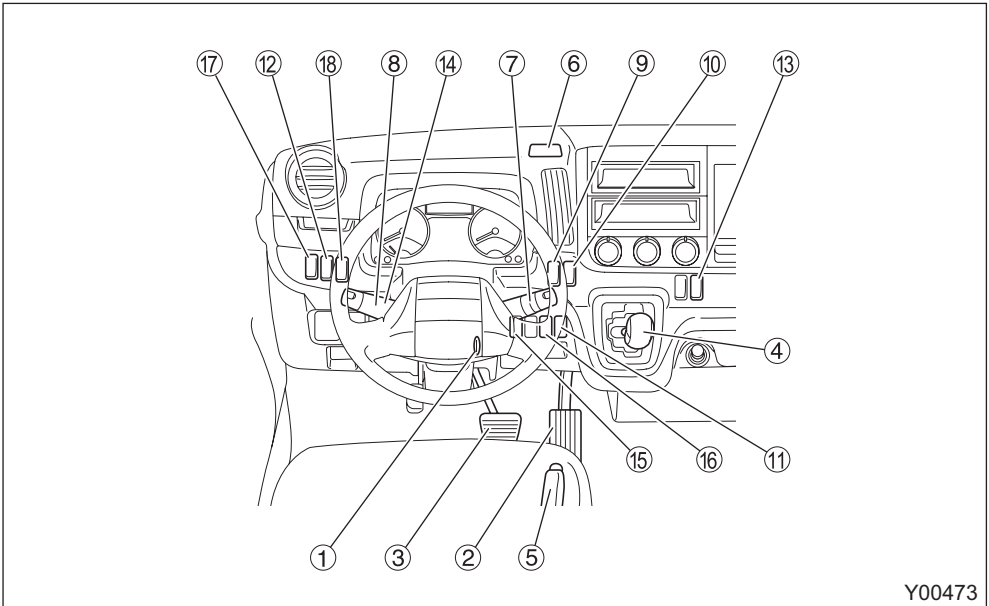

Y00473

- ① Starter switch
- ② Accelerator pedal
- ③ Brake pedal
- ④ Gearshift lever
- ⑤ Parking brake lever
- ⑥ Hazard warning lamp switch
- ⑦ Combination switch
(wiper and washer switch, exhaust brake switch*)
- ⑧ Combination switch
(lighting switch, passing signal/dimmer switch, turn signal switch)
- ⑨ Front drive switch <FG> ⇨ P. 8-3
- ⑩ ECO mode switch
- ⑪ DPF cleaning switch
- ⑫ Central door lock switch ⇨ P. 3-8
- ⑬ Cruise control main switch
- ⑭ Cruise control SET/RESUME switch
- ⑮ Van body dome light switch
- ⑯ Heated mirror switch*
- ⑰ Transmission PTO switch*
- ⑱ Front fog lamp switch*

*: If equipped

STARTER SWITCH

1 Starter switch position

WARNING

Never turn the starter switch to any position other than the “ON” position while driving the vehicle. Turning the starter switch to the “ACC” position would be dangerous because the engine would stop and the following problems would occur:

- The braking force is severely reduced.
- The power steering system would stop working so the steering action would become extremely heavy.
- The fuel injection system can malfunction.
- The electric circuits for the warning lamps and meters would stop working, and electric parts could fail.

When the starter key is removed from the starter switch, the steering wheel locks, making steering impossible.

CAUTION

- Do not turn the starter switch to the “START” position while the engine is running. Doing so could damage the starter.
- The starter key cannot be turned from the “ACC” position to the “LOCK” position unless it is pressed in. Do not attempt to turn it by force. Keep the key pressed in while turning it from the “ACC” position to the “LOCK” position.
- If you park the vehicle over an extended period of time, always remove the key from the starter switch. Leaving the key in the “LOCK”, “ON” or “ACC” position could run down the battery.
- Avoid using the “ACC” position for long periods, for example, for listening to the radio, as the battery could become completely discharged.

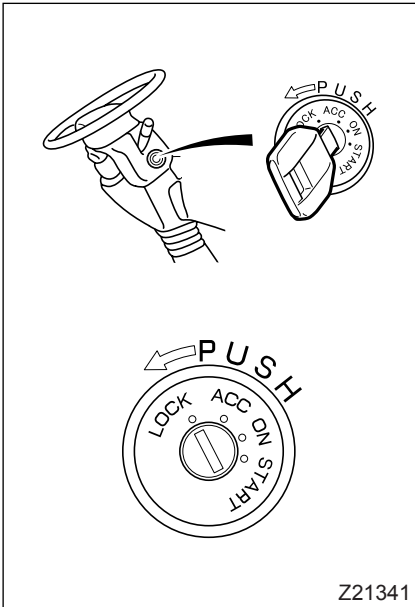

- **LOCK**
The starter key can be inserted and removed in this position only. To place the key in the “LOCK” position, turn it to the “ACC” position then press it in. Keep it pressed in while turning it to the “LOCK” position. When the key is removed, the steering wheel locks.
The lighting switch, hazard warning lamps, interior lamp, horn, central door locks and turn signal lamps can be used.
- **ACC**
The engine is shut off or is not running in this position.
The cigarette lighter can be used. Audio equipment (radio, etc.) installed and connected in the approved manner can also be used.
- **ON**
The engine is running in this position.
All electrical circuits are operable.
- **START**
The engine turns and starts in this position.
Once the engine is running, release the key and the switch will automatically return to the “ON” position.

NOTE:

- *Turn the key only after inserting it fully in the starter switch.*
- *If you are unable to turn the key, gently turn the steering wheel clockwise and counterclockwise as you turn the key.*
- *The starter key can neither be turned to the “LOCK” position nor pulled out unless the gear-shift lever is in the “P” position.*

2 Key in starter reminder alarm

A buzzer sounds if you open the door with the engine shut down and the key left in the starter switch. Remove the starter key from the switch and keep it with you whenever leaving the vehicle.

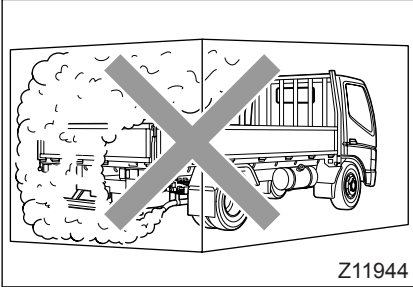
STARTING THE ENGINE**⚠ WARNING**

- Do not start or warm up the engine in a garage or other closed area. When starting the engine or entering or leaving a garage, do not run the engine for longer than is necessary as the accumulation of exhaust gas in closed areas is very dangerous. Exhaust emissions contain carbon monoxide (CO), which if breathed can cause unconsciousness or death.
- If you smell exhaust gases inside the cab, inspect the exhaust pipe and check whether exhaust gases are leaking through holes or cracks caused by corrosion or damage. If exhaust gases are leaking, have the exhaust pipe inspected by an authorized dealer.
If exhaust gases that have leaked from the exhaust pipe come into the cab, ventilate the cab with fresh air by opening the windows fully or by opening the doors.
- Make sure that there are no flammables under or behind the parked vehicle, especially close to the exhaust pipe. A fire could be started by the heat from the engine or exhaust pipe.
- When you start the engine, be sure to sit in the correct position on the driver's seat to wait for the engine to warm up. If you are leaning out of the door window or otherwise incorrectly seated and the vehicle suddenly moves, a serious accident could occur.

⚠ CAUTION

- Do not try to push-start the engine. Push-starting the engine is impossible for this vehicle and could damage the transmission. Add the engine oil if the oil level is low.
- Do not turn the starter switch to the “START” position numerous times rapidly. Doing so may damage the starter and engine or cause them to malfunction. Wait at least 3 seconds between attempts.
- Do not continue operating the starter for more than 15 seconds as this could damage it or discharge the battery.

NOTE:

If you operate the starter continuously for 10 seconds and the engine still does not start, turn the starter switch to the “ACC” position and wait about 30 seconds for the battery to recover before performing the starting procedure again.

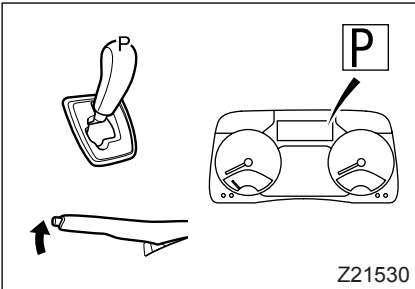

1 Pre-starting steps

1. Pull parking brake lever to fully apply the parking brake.
2. Place the gearshift lever in the “P” position. Make sure the gear position indicator displays “P”.

NOTE:

Your vehicle’s engine cannot be started unless the gearshift lever is in the “P” or “N” position. For safety, we recommend starting the engine with the gearshift lever in the “P” position. Use the “N” position only when absolutely necessary, for example, if the engine stops while the vehicle is on a railroad crossing.

2 Starting procedure

1. Fully depress the brake pedal.

CAUTION

For safety, keep the brake pedal depressed until the engine has started.

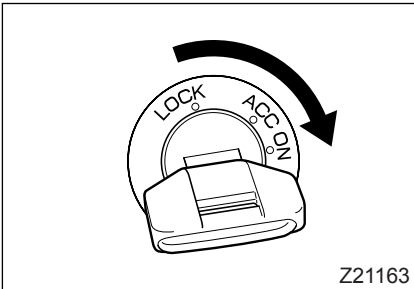
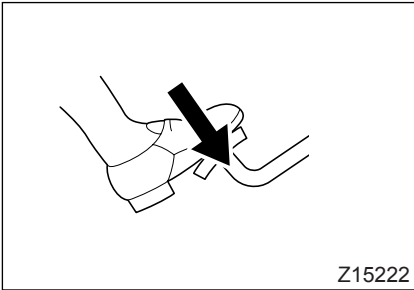

2. Turn the starter switch to the "ON" position.

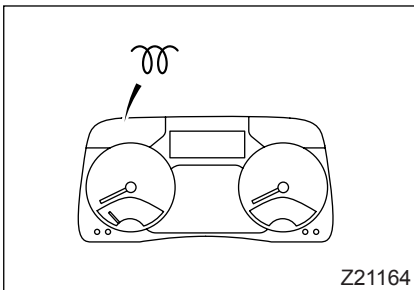

3. Check whether the  indicator lamp illuminates or not.

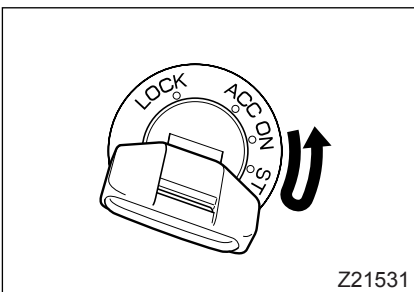

- **When the  indicator lamp does not illuminate**

While depressing the brake pedal, turn the starter switch to the "START" position to start the engine.

- **When the  indicator lamp illuminates**
The engine is being preheated. Wait until the indicator lamp goes out.
After that, while depressing the brake pedal, turn the starter switch to the “START” position to start the engine.

NOTE:

If the engine is difficult to start after the  indicator lamp has gone out, there may be a problem with the engine preheating system. Have the vehicle inspected by an authorized dealer.

4. After the engine has started, let it warm up for 1 to 2 minutes at idle speed, if possible.

⇒  P. 5-10

Engine idling speed
800 rpm

3 Starting the engine when vehicle has been parked over an extended period

When the vehicle is not used for a week or more or when the engine oil and oil filter are replaced, the engine becomes starved of oil. Before the engine is started, the proper engine cranking procedure must be performed to distribute oil to its various components.

NOTE:

Properly performing the engine cranking procedure will help prevent damage to the turbocharger.

1. Pull the parking brake lever to fully apply the parking brake.
2. Place the gearshift lever in the “P” position.
3. Start the engine. You do not need to wait for  indicator lamp to turn off.
4. Without depressing the accelerator pedal, place the starter switch in the “START” position and crank the engine for roughly 15 seconds.
If the engine starts, release the starter key and do not depress the accelerator pedal for roughly 15 seconds.

4 Starting the engine with the cab tilted

When you need to start the engine with the cab tilted for inspection or servicing purposes, be sure to observe the following safety precautions:

- Set the parking brake firmly and chock the wheels.
- Make sure the gearshift lever is placed in the “P” position and the gear position indicator shows “P”.
- Make sure nobody is near the engine compartment, then place the starter switch in the “START” position to start the engine.

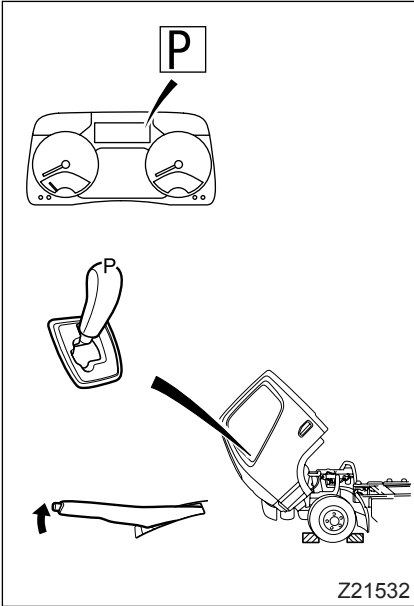

Z21532

WARMING UP THE ENGINE

Let the engine warm up for 1 to 2 minutes before starting the vehicle, if possible.

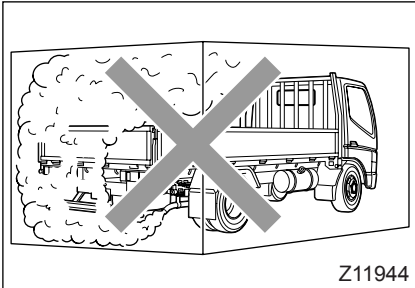
**! WARNING**

- Do not warm up the engine in a garage or other closed area. When starting the engine or entering or leaving a garage, do not run the engine for longer than is necessary as the accumulation of exhaust gas in closed areas is very dangerous. Exhaust emissions contain carbon monoxide (CO), which if breathed can cause unconsciousness or death.
- If you smell exhaust gases inside the cab, inspect the exhaust pipe and check whether exhaust gases are leaking through holes or cracks caused by corrosion or damage. If exhaust gases are leaking, have the exhaust pipe inspected by an authorized dealer.
If exhaust gases that have leaked from the exhaust pipe come into the cab, ventilate the cab with fresh air by opening the windows fully or by opening the doors.
- Make sure that there are no flammables under or behind the parked vehicle, especially close to the exhaust pipe. A fire could be started by the heat from the engine or exhaust pipe.

! CAUTION

Racing the engine immediately after it has started causes excessive wear of cylinders and pistons, leading to engine malfunction. This also causes a fault in the turbocharger as the turbocharger starts spinning at high speed before engine oil is sufficiently distributed to its shaft. Be sure to warm up the engine to operating temperature before full load operation according to the procedures described here.

NOTE:

- *Leaving the vehicle idling for a long time causes poor fuel efficiency and deterioration of engine oil. Avoid any unnecessary idling.*
- *In a cold region, the extreme coldness of the engine will cause poor fuel ignition, making the engine prone to knocking.*

- You may encounter any or all of the following conditions. They are due to the actions particular to the oxidation catalyst inside the muffler and do not indicate any abnormalities.
 - White smoke from the exhaust pipe when setting the vehicle in motion after idling the engine for a relatively long-time or when accelerating the vehicle.
 - White smoke from the exhaust pipe when the vehicle starts off immediately after the engine is started.
 - There is a strong odor from the exhaust system (with a vinegar-like odor).
- In cold months, the engine may operate at an idling speed higher than usual just after its start. The engine speed, however, will drop to a normal speed as the coolant warms up.
- Insufficiently warming up the engine may cause sluggish gear shifting.

STOPPING THE ENGINE **WARNING**

- Never allow the vehicle to coast with the engine stopped as braking may be dangerously sluggish and extremely difficult steering may result. This may also cause trouble in the fuel injection system.
- The engine and exhaust pipe are extremely hot just after stopping the vehicle. Avoid parking the vehicle where the exhaust pipe could set fire to materials such as dry grass.
- Do not stop the engine for parking with the steering wheel fully turned to either direction. This will cause the power steering system pressure to drop, thus causing the steering wheel to return rapidly, possibly injuring you.
- Do not park on a slope. A vehicle parked on a slope can move uncontrollably and cause an accident.

If it is unavoidable to park the vehicle on a slope, do the following: Firmly apply the parking brake, place the gearshift lever in the “P” position, chock the wheels, and turn the steering wheel toward an obstruction (like a curb stone) for increased safety in case the vehicle moves.

- Do not park the vehicle only with the gearshift lever placed in the “P” position; always firmly engage the parking brake. If you park the vehicle on a steep slope only by placing the gearshift lever in the “P” position without also engaging the parking brake, the gearshift lever will become extremely difficult to move or, in the worst case, it may be impossible to release the transmission from the locked state. If this happens, shift the gearshift lever into the “N” position and then, after making sure the gear position indicator shows “N”, move the lever to the “D” position.

! CAUTION

- If you stop the engine immediately after uphill or high-speed driving, the oil supplied to the rotor shaft of the turbocharger will rise to an abnormally high temperature and the rotor shafts could seize up. To avoid this, run the engine at idle for at least 3 minutes instead of stopping it immediately, if possible.
- The engine should only be stopped from an idle. Stopping it at a high RPM could result in an engine malfunction.

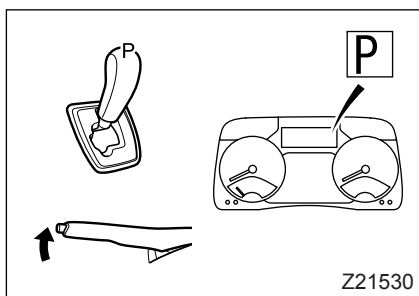

1. Hold down the brake pedal and apply the parking brake.
2. Place the gearshift lever in the "P" position. Make sure the gear position indicator shows "P".

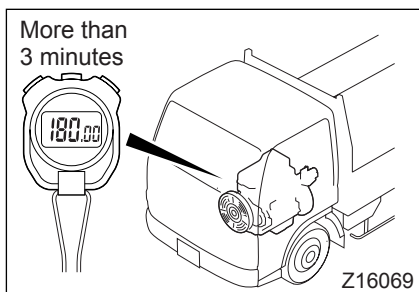

3. Allow the engine to idle for more than 3 minutes before stopping it, if possible. When the vehicle is in motion, engine parts become extremely hot. This is particularly true during uphill or high-speed driving. Therefore, let the engine cool down sufficiently by allowing it to idle for a time before stopping it.

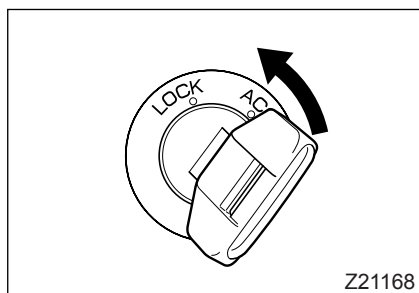

4. Turn the starter switch to the "ACC" position to stop the engine.

NOTE:

Before you leave your vehicle, be sure to remove the starter key from the starter switch and lock all the doors.

To remove the starter key, keep the key pressed in while turning it from the "ACC" position to the "LOCK" position.

PEDALS

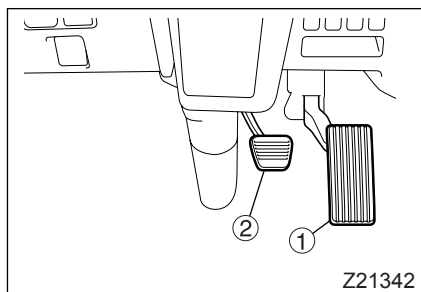

① Accelerator pedal

! WARNING

If you use a floor mat, be sure to use a Mitsubishi Fuso genuine floor mat and lay it correctly. Do not lay the floor mat over the accelerator pedal or accelerator pedal stopper. Do not lay a floor mat over another floor mat. Failure to observe these instructions would be dangerous because the accelerator pedal could be prevented from returning when released.

NOTE:

If the floor mat is in contact with the accelerator pedal and the pedal does not return, pressing the brake pedal will disable the accelerator pedal to increase safety. Likewise, if you accidentally press the brake pedal while also pressing the accelerator pedal, the accelerator pedal will be disabled to increase safety.

② Brake pedal

! WARNING

- Do not allow empty beverage cans or other objects to get under the brake pedal as they may hinder the brake pedal operation, leading to an extremely dangerous situation. Keep the floor clear of empty beverage cans and other objects.
- Always use the right foot to depress the brake pedal. If you use the left foot, the pedal-pressing action will not be fully responsive, which could lead to an accident especially in the case of emergency braking. Before starting the engine, depress the accelerator pedal and brake pedal with your right foot to confirm the locations of these pedals.

- If your vehicle is equipped with disc brakes and you notice squealing during braking, the disc brake pads have worn to the limit and must be replaced. Have the vehicle inspected by an authorized dealer.
- Use the brake pedal correctly. ⇨ P. 7-8

PARKING BRAKE LEVER

WARNING

- Do not use the parking brake when driving except in an emergency, like if the service brakes have failed. Such use of the parking brake may make the vehicle spin or, at worst, roll over. It may also cause faults in vehicle components.
- Pull up the parking brake lever all the way to properly apply the parking brake. There is no relationship between illumination of the BRAKE warning lamp and the parking brake. Pulling the lever insufficiently will not apply the parking brake properly, and the vehicle could move while parked and cause a serious accident.

1 Using the parking brake lever

① Parking

The parking brake is activated when the parking brake lever is fully pulled up. The BRAKE warning lamp illuminates simultaneously.

② Releasing

Raise the lever slightly, press the end button ③, and lower the lever with the button still pressed. Make sure that the BRAKE warning lamp extinguishes.

- When parking, review the cautions in “PARKING”, chapter 7. ⇨  P. 7-16

2 Parking brake alarm

- If you start the vehicle without releasing the parking brake and the vehicle moves at a speed of 12 km/h (7 mph) or higher, a buzzer will sound (beeps intermittently) 3 seconds later to warn you.
- If the buzzer sounds, immediately stop the vehicle in a safe place and then release the parking brake.

CAUTION

- Before putting the vehicle in motion, completely release the parking brake lever and check that the BRAKE warning lamp is not illuminated. If you accidentally drive the vehicle with the parking brake applied, the parking brake will wear prematurely and overheat, leading to reduced effectiveness and the risk of a fire.
- When parking your vehicle on a slope, block the wheels with chocks for added safety.

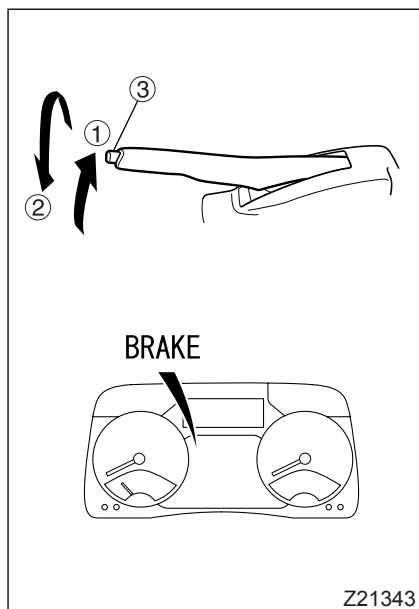

Z21343

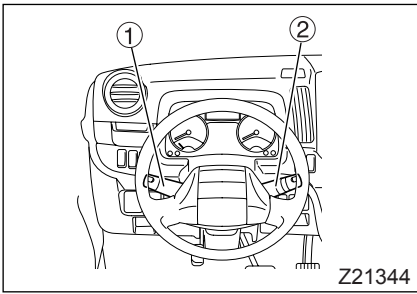

Z21344

COMBINATION SWITCH

1 Switch arrangement

- ① Lighting switch
 Passing/dimmer switch
 Turn signal switch
- ② Exhaust brake switch*
 Wiper and washer switch

2 Lighting switch

CAUTION

- Keeping the headlamps on for a long period without the engine running can drain the battery, making the engine impossible to start.
- Do not touch any lens while the lamp is illuminated or immediately after it has extinguished. The lens is very hot then and could burn you.

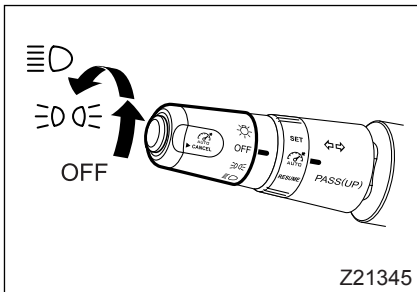

Z21345

The lighting switch can be used with the starter switch in any position. Rotating the knob at the end of the lever controls the illumination of lamps as follows:







	Identification, clearance and side marker, parking, tail, license, front fog*1 and meter cluster illumination lamps	Headlamps
OFF position	Off	On*2
position	On	On*2
position	On	On

*1: If equipped

*2: Illuminated by daytime running light system

*: If equipped

NOTE:

- The front fog lamps* light if the front fog lamp switch is turned on when the lighting switch is in the  or  position. ⇨  P. 5-45
- Even when the vehicle is operated with the lighting switch in the "OFF" or  position, the daytime running light system causes the low-beam headlamps to be illuminated. (The headlamps are dimmer than when activated using the lighting switch.) The  indicator lamp is also illuminated. When the parking brake is applied or the engine is stopped, the headlamps and the  indicator lamp extinguish.

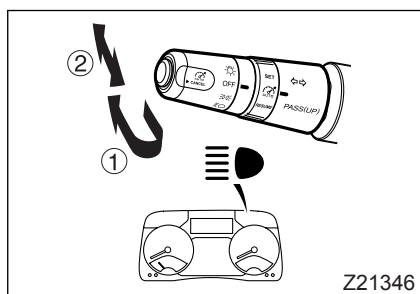

**3 Passing signal/dimmer switch****① Passing signal**

Pulling the lever up activates the high beams until the lever is released. The  indicator lamp illuminates simultaneously.

② Dimmer

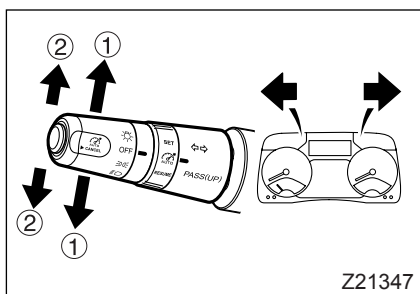

With the headlamps illuminated, pushing the lever down activates the headlamp high beams and pulling it back to the original position reactivates the low beams. When the high beams are on, indicator lamp  illuminates.

**4 Turn signal lamp switch****① Turn signal**

Pushing the lever up or down activates the corresponding turn signal causing it to flash. At the same time, the corresponding indicator lamp  or  flashes.

When the steering wheel is returned to the neutral position after a right or left turn, the switch automatically moves back to the normal position and the lamp stops flashing. After making a moderate turn, however, the switch will sometimes not return automatically. In this case, put the switch in the normal position by hand.

② Lane changer

Lightly pushing the lever up or down causes the corresponding turn signal lamp to flash while the lever is held in this position. At the same time, the corresponding indicator lamp  or  flashes.

5 Exhaust brake*

WARNING

- Reduce the vehicle speed before negotiating a curve while braking. If the tires slip due to the road surface being slippery or when the vehicle passes over a step in the road, the ABS may function, causing the exhaust brake to be temporarily released, which may result in a serious accident.
- Using the exhaust brake on a wet, frozen, snow-covered, or otherwise slippery road surface when the vehicle is lightly loaded or not loaded can cause the tires to slip on the road surface, resulting in a skid. Do not use the exhaust brake on slippery road surfaces.

The exhaust brake enhances engine braking. Use it as an auxiliary braking means on downhill stretches or during high-speed driving.

NOTE:

- Do not keep the exhaust brake switch in the activation position at all times. Keeping the switch in the activation position worsens fuel consumption, as doing so causes the exhaust brake to work frequently and the vehicle to decelerate and accelerate frequently. Save fuel by using the exhaust brake switch appropriately according to road and traffic conditions.
- The exhaust brake is activated when the automatic DPF regeneration takes place during parking. The  indicator, however, is not illuminated.

• Operation of the exhaust brake

Pushing the lever up activates the exhaust brake. While the exhaust brake is activated, the  indicator lamp stays illuminated.

- ① Deactivated
- ② Activated

The exhaust brake will be temporarily disabled in the following conditions:

- The accelerator pedal is depressed.
- The gearshift lever is moved to “N”.
- The ABS is operating.

Full functionality will be returned when the original conditions have been restored.

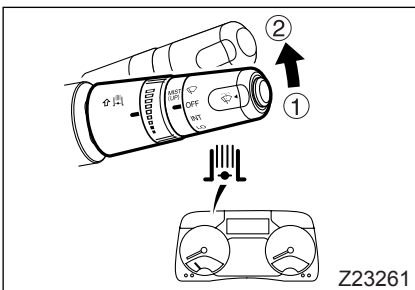

*: If equipped

6 Wiper and washer switch

WARNING

In cold weather, warm the windshield with the heater before operating the washer since washer fluid could otherwise freeze onto the windshield and obstruct your vision.

CAUTION

- Do not operate the wipers while the wiper arms are raised. Doing so will cause damage to the wiper arms.
- Operating the wipers when the windshield is dry damages the windshield glass. If the glass is dry, be sure to squirt it with washer fluid before operating the wipers.
- Check nearby conditions before operating the washer switch. Washer fluid may splash around in some circumstances.
- Do not operate the wipers when the rubber parts of the wiper blades are frozen onto the windshield or otherwise stuck to the windshield. The wiper blades could get damaged, and the wiper motor could fail.
- When the wipers are not used for a long time, dust, sand, and other substances can collect between the wiper blades and windshield. Clean the wipers before using them. Otherwise, the windshield may get scratched.
- Operating the washer continuously for more than 20 seconds or when there is no fluid in the reservoir could burn out the washer motor.
- Rotating the switch at the end of the lever activates the windshield wipers in one of the following three modes:

INT: Wipers operate intermittently. By operating the interval control switch, the operating interval of wipers can be varied between 3 and 12 seconds.

LO: Wipers operate at a slow speed.

HI: Wipers operate at a rapid speed.

MIST: The wipers operate once when you flip up the lever toward you.

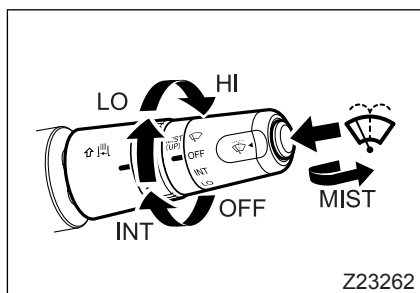

Replace the wiper blades if they start to work ineffectively.

 **CAUTION**

The rubber part of wiper blade can deteriorate over time, causing the wipers to work ineffectively and possibly causing the windshield to be scratched.

- Pressing the button sprays washer fluid onto the windshield.
- Refill the washer fluid reservoir before it is empty. ⇒  P. 12-89
- If there is washer fluid in the reservoir but none is sprayed when you operate the washer, the nozzles may be blocked. Clean the nozzles using a piece of thin wire. If fluid is still not sprayed when you operate the washer, have the vehicle inspected by an authorized dealer.

DUONIC®

The DUONIC® system combines the controls of the clutch, transmission and engine into a single system to achieve automatic clutch engagement/disengagement and gear shifting.

The clutch mechanism incorporates two clutch systems (called a “dual-clutch”), allowing the DUONIC® system to provide smooth gear shifting with minimum shock.

NOTE:

DUONIC® is a registered trademark of Daimler AG.

1 What you should know before you can safely and properly operate your vehicle

1.1 Before starting the engine

Before starting the engine, step on the accelerator pedal and brake pedal with your right foot to check and get a feel for their locations.

1.2 Creep

Creep refers to a very slow vehicle movement that occurs when the gearshift lever is placed in a driving position and the accelerator pedal is released. This occurs due to the power transmitted from an idling engine.

CAUTION

- **To prevent creep, keep the brake pedal firmly pressed when moving the gearshift lever to the “R” or “D” position. Do not release the parking brake until you have finished the shift operation.**
- **Continue depressing the brake pedal fully while the position indication on the gear position indicator is still flashing. This is especially important when starting on an uphill road. As the gear is not yet engaged and thus the creep effect is not available while the display is flashing, the vehicle may move backward if the brake pedal is released, which could cause an accident.**

1.3 Brake pedal operation

CAUTION

Always use the right foot to depress the brake pedal. If you use the left foot, the pedal-pressing action will not be fully responsive, which could lead to an accident especially in the case of emergency braking. Before starting the engine, step on the accelerator pedal and brake pedal with your right foot to confirm the locations of these pedals.

1.4 Leaving the vehicle with the engine running

Before leaving the vehicle, make sure the parking brake is firmly applied, the gearshift lever is in the “P” position, and the gear position indicator is showing “P”. If you open the door with the engine running and the gearshift lever in the “D” position, a buzzer will sound continuously to warn you.

If you place the gearshift lever in the “R” position with the engine running, the buzzer will sound intermittently.

1.5 Parking

Park the vehicle on a level, flat surface if possible. When parking the vehicle, do the following:

While keeping the brake pedal depressed, firmly apply the parking brake and then place the gearshift lever in the “P” position.

If it is unavoidable to park the vehicle on a slope, firmly engage the parking brake while keeping the brake pedal depressed, and then place the gearshift lever in the “P” position. In addition, chock the wheels.

1.6 Selecting the “R” (reverse) position

Bring the vehicle to a complete stop before placing the gearshift lever in the “R” position. The “R” position cannot be selected while the vehicle is moving.

1.7 Towing

If it becomes necessary to tow the vehicle, observe the following. Doing otherwise could damage the DUONIC[®] system. Never attempt to push-start the engine.

- On an FE model vehicle, disconnect the propeller shaft or rear axle shafts, or have the towing vehicle to raise the rear wheels before towing the vehicle.
- Before towing a 4WD vehicle, raise the front wheels and disconnect the propeller shaft at the rear before towing the vehicle.

1.8 Driving on a slippery road

WARNING

Use the manual shift mode when driving on slippery surfaces (such as a wet or frozen road). Using the automatic shift mode on slippery roads could cause an accident for the following reasons:

Skidding is more likely to be caused by automatic shift-downs that take place normally when driving in the automatic shift mode. Skidding also may occur easily due to automatic shift-downs following full or quick operation of the accelerator pedal.

Even while driving using the manual shift mode, the vehicle is likely to skid if you suddenly depress the accelerator pedal or quickly shift down the gear.

1.9 Starting on uphill roads

The vehicle may move backward when starting on an uphill road even though the creep effect helps to reduce backward movement. If the vehicle seems likely to move backward, be sure to also use the parking brake.

2 Controls and indicators

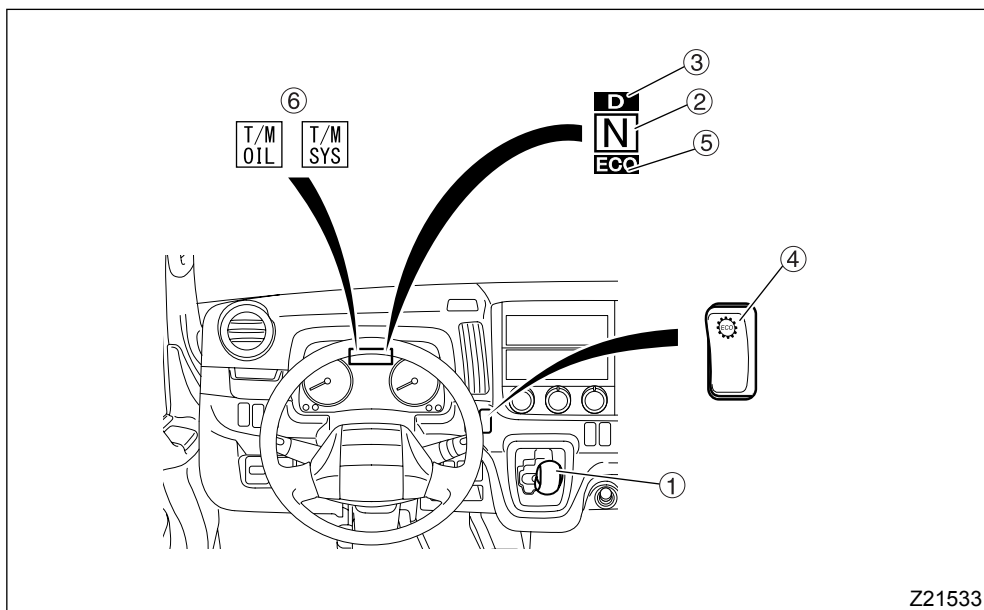

Z21533

① Gearshift lever

Used to control the operation of the DUONIC® system. Move the lever until it completely engages in each position.

② Gear position indicator

Indicates the selected gear of the transmission.

③ Automatic shift mode indicator

This indication appears while driving in the automatic shift mode.

④ ECO mode switch

When this switch is turned on, the economy mode works to make early up-shifts to improve fuel economy.



This switch is usable when driving in the automatic shift mode.

⑤ ECO mode indicator

This indication appears when the economy mode is activated.

⑥ Warnings

If there is a problem with the DUONIC® system, one of the following warnings appears on the multi-information display.



-  (red)
Indicates that the DUONIC® system is faulty.
-  (red)
Indicates that the clutch control fluid or the clutch temperature is abnormally high.

-  (amber)
 Indicates that the DUONIC[®] system is faulty (but the vehicle may be driven if automatic or manual gear shifting is possible).



3 Gearshift lever

This lever is used to control the operation of the DUONIC[®] system. Move the lever until it completely engages in each position.

3.1 How to operate the gearshift lever

- To switch from the automatic shift mode to the manual shift mode, use either of the following methods with the gearshift lever in the “D” position:
 - Move the gearshift lever to the “+” or “-” position.
 - Push the gearshift lever into the “A/M” position.
- The indication “” on the multi-information display disappears when the manual shift mode is engaged.
- To switch from the manual shift mode back to the automatic shift mode, push the gearshift lever into the “A/M” position from the “D” position. The automatic shift indicator shows “” when the automatic shift mode is engaged.
- When you release the gearshift lever after moving it to the “+”, “-” or “A/M” position, it will return to the “D” position.

NOTE:

- Unless the engine is started, operating the gearshift lever has no effect on the DUONIC[®] system.*
- The following gearshift lever movements are possible only while the brake pedal is depressed: “P” to “R”; “N” to “R”*
- If the battery is discharged, the gearshift lever will stay locked and cannot be operated even if the brake pedal is depressed. At this time, if the gearshift lever is in the “P” position, the vehicle cannot be moved.*
Restore the battery by any of the following methods:
 - Charge the battery.
 - Replace the battery. ⇨  P. 12-90
 - Connect the discharged battery to the battery of another vehicle with booster cables. ⇨  P. 13-29

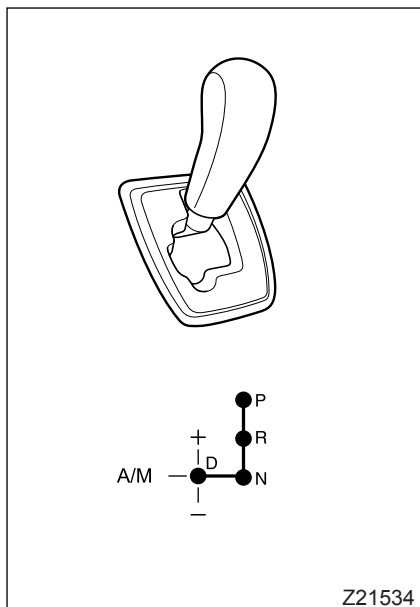

Z21534

3.2 Gearshift positions

P: Parking

- Use this position when starting or warming up the engine of a stopped or parked vehicle.
- The starter key can be removed when the gearshift lever is in this position.
- Use this position when using the PTO.

R: Reverse

- Use this position to reverse the vehicle.
- The backup lamps come on and a buzzer sounds simultaneously when the gearshift lever is in this position.

N: Neutral

- No power is transmitted to the wheels.
- Only in an emergency, you can use this position for starting the engine.

D: Drive

- This is the position for driving.
- In the automatic shift mode, gearshifts take place automatically based on vehicle load and speed.

Gearshift pattern
1 ↔ 2 ↔ 3 ↔ 4 ↔ 5 ↔ 6

NOTE:

The DUONIC[®] system automatically selects the starting gear according to the steepness of the slope and the vehicle loading. It selects 2nd on a level or downhill road and 1st on an uphill road.

- Moving the gearshift lever from “D” position to the “A/M”, “+”, or “-” position causes the manual shift mode to be selected.

A/M: Automatic/manual shift mode

Each time you push the gearshift lever into this position, the gearshift mode switches between the automatic shift mode and manual shift mode.

+: Upshift

- Use this position for manual upshifts.
- The gear shifts up by one gear each time you move the gearshift lever to this position from the “D” position.

-: Downshift

- Use this position for manual downshifts.
- The gear shifts down by one gear each time you move the gearshift lever to this position from the “D” position.

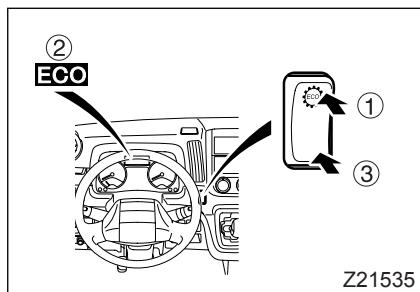

4 ECO mode switch

You can use the ECO mode switch only while driving in the automatic shift mode.

When the ECO mode is turned on using this switch, the DUONIC® system applies the following control:

- Performs upshifts earlier than when the ECO mode is off.
- Limits automatic downshifting when the accelerator pedal is depressed.
- The ECO mode is activated when the “ON” side ① of this switch is pressed. The multi-information display will then indicate “ECO” ② on the screen. Press the “OFF” side ③ of the switch to deselect the ECO mode.

NOTE:

- *The ECO mode should be used when the vehicle is half-loaded or less and driven on relatively level roads.*
- *Turn off the ECO mode switch when the vehicle is fully loaded or is driven on uphill or downhill roads.*

5 Driving tips

WARNING

- **When you start the vehicle, never operate the gearshift lever while depressing the accelerator pedal. The vehicle will suddenly lurch forward and could cause a serious accident. Be sure to depress the brake pedal whenever operating the gearshift lever while starting the vehicle.**
- **Never race the engine when the vehicle is stopped. If the gearshift lever happens to have been placed in any position other than “P” or “N”, the vehicle will suddenly lurch and could cause a serious accident.**

CAUTION

- **Always fully depress the brake pedal when moving the gearshift lever to the “D” or “R” position. Otherwise, the vehicle will creep and could cause an accident.**

- On downhill roads, never start the vehicle with the gearshift lever in the “N” position. Be sure to place the lever in the “D” position instead. If the gearshift lever is in the “N” position, engine braking does not work, which increases the risk of an accident.
- If there are steps or other sharp changes in height on the surface in front of the vehicle, depress the accelerator pedal carefully when starting the vehicle. Recklessly stepping on the accelerator pedal is dangerous as the vehicle could move unexpectedly quickly.
- Do not pump the accelerator pedal when starting the vehicle, as this will increase the chance of damaging the transmission.
- When starting the vehicle (on a slope, for example), do not use a forward gear if the vehicle is moving backward or do not place the gearshift lever in the “R” position if the vehicle is moving forward. Such actions will increase the chance of damaging the transmission.
- The following actions will cause excessive slipping of the clutch and heat generation. Refrain these operations at may cause of the transmission oil temperature warning.
 - On an uphill road, avoid stopping the vehicle by only using the accelerator pedal. Otherwise, a slipping or broken clutch may result. Be sure to stop the vehicle using the brake pedal on an uphill road.
 - Do not operate the accelerator pedal when the gearshift lever is in the “D” or “R” position and the service brakes or parking brake are applied. Failure to follow this instruction will damage the transmission.
 - Do not move the vehicle very slowly repeatedly to drive over a high step or curb. Otherwise, a slipping or broken clutch may result.

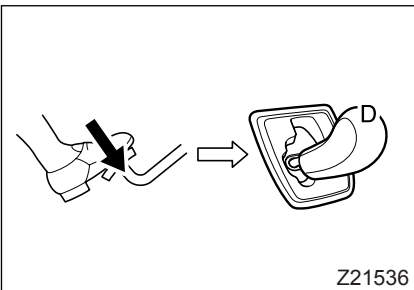

5.1 Starting

- **Automatic shift mode**
1. While keeping the brake pedal fully depressed, place the gearshift lever into the “D” position.

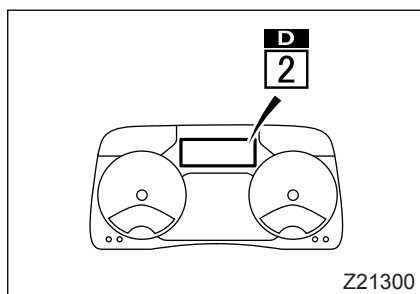

2. Check that the multi-information display is showing “**D**” and that the gear position indicator is showing “1” or “2”.

NOTE:

- The **DUONIC**[®] system selects the starting gear automatically according to the steepness of the slope and the vehicle loading. It selects 2nd on a level or downhill road and 1st on an uphill road.
- Start the vehicle only when the gear position indicator indicates “1” or “2”. When starting after the ABS has been activated, the system may take longer than usual to engage the starting gear.
- The starting gear engagement is still in progress while the indication on the gear position indicator is flashing. Do not release the brake pedal at this time.

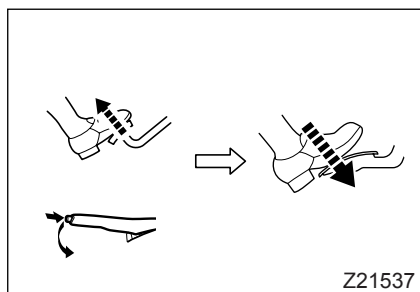

3. Release the parking brake. Gradually release the brake pedal and then slowly depress the accelerator pedal to start the vehicle.

- **Manual shift mode**

You can select 1st, 2nd or 3rd as the starting gear.

! CAUTION

- Except when starting on a downhill road, do not select 3rd gear. Selecting 3rd gear when starting in any other condition could cause a transmission failure. While starting, the system automatically prevents the 4th and higher gears from being selected.

- **Start the vehicle only when the gear position indicator indicates “1”, “2” or “3”. When starting after the ABS has been activated, the system may take longer than usual to engage the starting gear.**

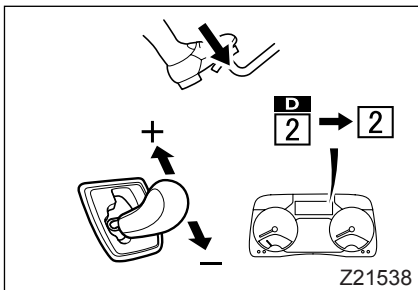

1. Fully depress the brake pedal.
 2. Move the gearshift lever from the “D” position to the “+” or “-” position.
- The gear shifts up by one gear each time you move the lever to “+”.
 - The gear shifts down by one gear each time you move the lever to “-”.

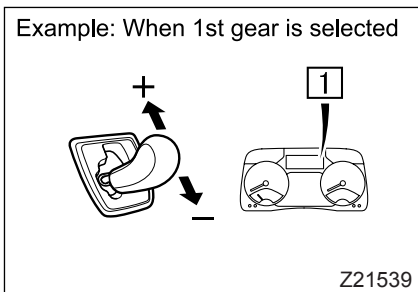

The “D” indication on the multi-information display disappears when the manual shift mode is engaged.

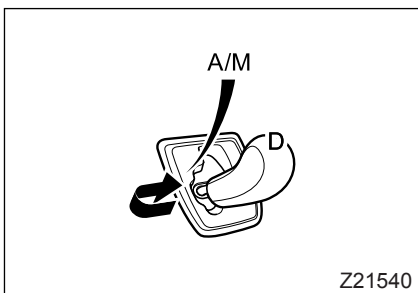

The gearshift mode also can be changed between “manual” and “automatic” each time you push the gearshift lever from the “D” position into the “A/M” position.

NOTE:

The starting gear engagement is still in progress while the indication on the gear position indicator is flashing. Do not release the brake pedal at this time.

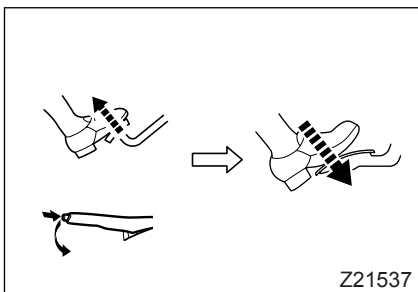

3. Make sure the gear position indicator is showing the desired gear.
4. Release the parking brake. Gradually release the brake pedal and then slowly depress the accelerator pedal to start the vehicle.

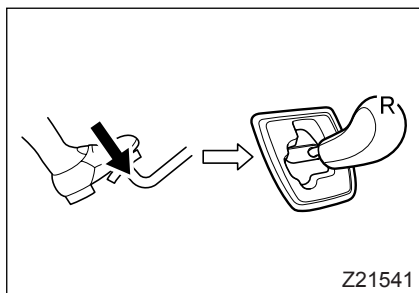

5.2 Reversing

1. While holding the brake pedal fully depressed, place the gearshift lever into the “R” position.
2. Check that the gear position indicator shows “R”.

NOTE:

- While the vehicle is moving, the reverse gear does not engage even if you place the gearshift lever into the “R” position. Always place the gearshift lever into the “R” position when the vehicle is stopped.
- Reverse gear engagement is still in progress when the indication on the gear position indicator is flashing. Do not release the brake pedal at this time.
- 3. Release the parking brake. Gradually release the brake pedal and then slowly depress the accelerator pedal to reverse the vehicle.

6 Driving

It is recommended to use the automatic shift mode for ordinary driving to reduce your workload.

CAUTION

- **Never place the gearshift lever into the “N” position while driving. This could result in an accident as engine braking is not available, and could damage the transmission.**
- **Use the manual shift mode when driving on slippery surfaces (such as a wet or frozen road). Using the automatic shift mode on slippery roads could cause an accident for the following reasons:**
Skidding is more likely to be caused by automatic shift-downs that take place normally when driving in the automatic shift mode. Skidding also may occur easily due to automatic shift-downs following full or quick operation of the accelerator pedal.
Even while driving using the manual shift mode, the vehicle is likely to skid if you suddenly depress the accelerator pedal or quickly shift down the gear.

NOTE:

- In cold weather when the temperature of the transmission oil is low, you may experience slower automatic shift-downs from 3rd to 2nd and from 2nd to 1st than usual. This does not indicate any problem; shifting will return to normal speed as the oil temperature rises.
- There could be an instance when gear engagement is slow and you notice a delay in gear shifting. If this happens repeatedly, please have the vehicle inspected by an authorized dealer.

6.1 Driving in automatic shift mode

If you pull away and drive in the automatic shift mode, gearshifts take place automatically based on the accelerator pedal position and vehicle speed. The automatic shift mode indicator ① will be shown.

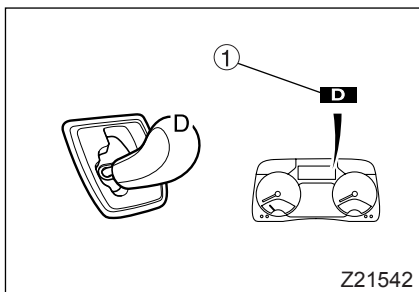

Gearshift pattern
1 ⇄ 2 ⇄ 3 ⇄ 4 ⇄ 5 ⇄ 6

NOTE:

The starting gear is automatically selected according to the steepness of the slope and the vehicle loading. The vehicle will start in 2nd on level and downhill roads and in 1st on uphill roads.

6.2 Driving in manual shift mode

Move the gearshift lever from the “D” position to the “A/M” position to switch from the automatic shift mode to the manual shift mode. You can also switch to the manual shift mode by moving the gearshift lever in the “+” or “-” direction.

The manual shift mode will then be set and the automatic shift indicator “” will disappear from the multi-information display.

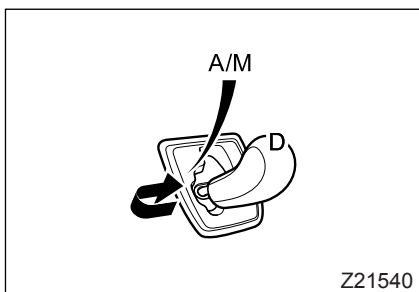

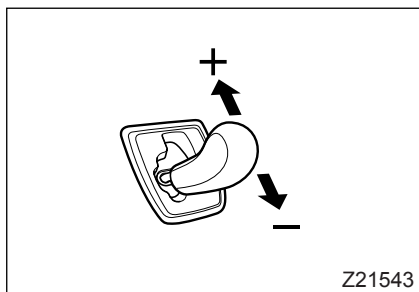

In the manual shift mode, the current gear selected will not change when the vehicle speed changes. Change the gear appropriately according to the vehicle speed.

- The gear upshifts by one gear each time you move the gearshift lever to the “+” position.
- The gear downshifts by one gear each time you move the gearshift lever to the “-” position.
- If the gearshift lever is moved to the “+” or “-” position multiple times, the gear will upshift or downshift as long as the engine is operating within the normal rpm range.

NOTE:

- *If the system determines that a manual upshift or downshift would put the engine speed out of the normal rpm range, the gearshift does not take place. If the gear does not change when you operate the gearshift lever, first adjust the vehicle speed using the accelerator or brake pedal and then operate the gearshift lever again.*
- *In cold weather when the temperature of the transmission oil is low, shifting down may be prohibited.*

If the gear does not change when you operate the gearshift lever, first reduce the vehicle speed using the accelerator or brake pedal and then operate the gearshift lever to downshift again.

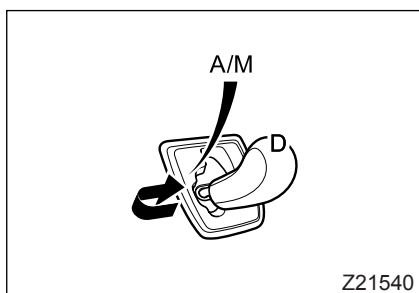

Push the gearshift lever into the “A/M” position if you want to change the gearshift mode from the manual shift mode to the automatic shift mode.

7 Moving out of mud, snow or sand

WARNING

Be sure to check safety around the vehicle before moving the vehicle by using fore-and-aft rocking motion. Failure to do so could result in an accident.

CAUTION

Do not try to free a stuck vehicle for more than 5 minutes. Prolonged rocking motion will damage the transmission or the clutch, as the transmission oil or the clutch quickly heats up to a dangerous temperature.

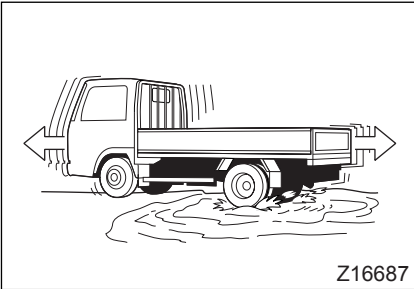

If your vehicle becomes stuck in mud, snow, or sand, it can often be moved using a rocking motion. Turn the steering wheel right and left to clear the area around the front wheels. Then shift back and forth between "D" and "N", while lightly pushing the accelerator. Use the minimum amount of accelerator pedal pressure that will maintain the rocking motion, without spinning the wheels or racing the engine.

8 Short stops

WARNING

Never race the engine when the vehicle is stopped. If the gearshift lever happens to have been placed in any position other than "P" or "N", the vehicle will suddenly lurch and could cause a serious accident.

CAUTION

On an uphill road, avoid stopping the vehicle by only using the accelerator pedal, as this could cause slipping or a broken clutch. Always use the brake pedal to stop the vehicle on an uphill road.

- When you stop the vehicle to wait at signals or in a traffic jam, the clutch automatically disengages as the vehicle slows down and an automatic gear change takes place as follows:
 - When driving in the automatic shift mode, the 2nd gear will be automatically engaged. On uphill roads, the 1st gear may be engaged depending on the steepness of the slope and the vehicle loading.
 - When driving in the manual shift mode, the 2nd gear will be automatically engaged if 3rd or higher gear was selected before stopping. On uphill roads, the 1st gear may be engaged depending on the steepness of the slope and the vehicle loading.
- Keep the brake pedal fully depressed while stopped.
- In the case of a prolonged stop, you can release the brake pedal after engaging the parking brake and placing the gearshift lever in the “P” position.

9 Leaving the vehicle with the engine running

Leave the vehicle after confirming the following:

1. The parking brake is firmly applied.
2. The gearshift lever is in the “P” position.
3. The gear position indicator is showing “P”.

NOTE:

A buzzer sounds continuously if the driver’s door or assistant driver’s door is opened while the engine is running and the gearshift lever is in the “D” position. The buzzer stops if the gearshift lever is moved to the “P” or “N” position, the engine is stopped, or the door is closed. If the gearshift lever is moved to the “R” position while the engine is running, the buzzer sounds intermittently. Always stop the engine with the gearshift lever in the “P” position.

10 If a transmission system warning appears

The multi-information display indicates a warning if there is a problem with the DUONIC® system. If a transmission system warning appears, take necessary action according to the following instructions.

10.1 warning (red)

- **If this warning appears while driving:**

Immediately slow down by braking and stop the vehicle in a safe place.

- **Actions to take after stopping the vehicle**

1. Place the gearshift lever in the "P" position and shut off the engine.
2. Restart the engine. If the engine cannot be started, contact an authorized dealer.
3. If the  warning (red) does not appear after the engine is started, you may continue to drive the vehicle. If the warning appears again, do not continue to drive the vehicle and contact an authorized dealer immediately.

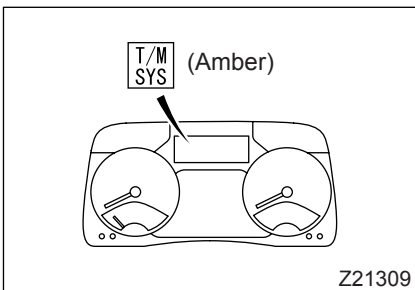
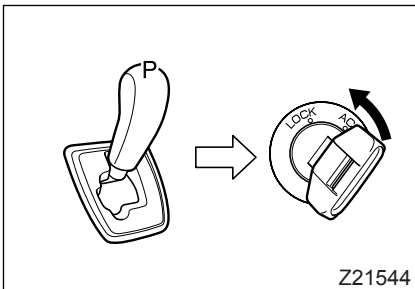
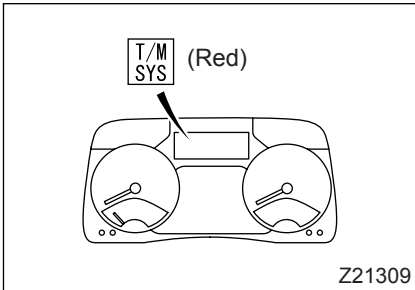

10.2 warning (amber)

- **If this warning appears while driving:**

- You may continue to drive if automatic gear shifting is possible in the automatic shift mode. However, have the vehicle inspected by an authorized dealer as soon as possible.
- If automatic gear shifting does not work in the automatic shift mode, stop the vehicle in a safe place.

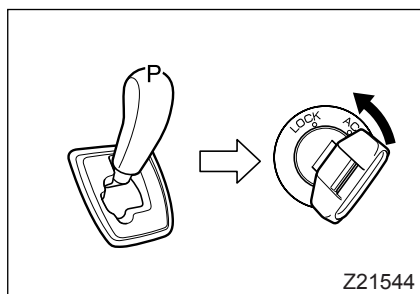

- **Actions to take after stopping the vehicle**

1. Place the gearshift lever in the "P" position and shut off the engine.
2. Restart the engine. If the engine cannot be started, contact an authorized dealer.
3. If the  warning (amber) does not appear after the engine is started, you may continue to drive the vehicle. If the warning appears again, operate the gearshift lever in the manual shift mode. You may continue to drive if manual gear shifting is possible. However, have the vehicle inspected by an authorized dealer as soon as possible. If manual gear shifting is impossible, do not continue to drive the vehicle and contact an authorized dealer.

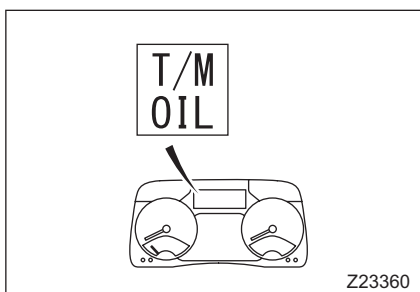

10.3 warning

- **If the warning appears and the buzzer sounds three times:**

This warning appears when the clutch control fluid temperature is too high.

If this warning appears while driving, stop the vehicle in a safe place and do the following:

- Place the gearshift lever in the "P" position, and run the engine slightly above idling speed by depressing the accelerator pedal to cool down the clutch control fluid.
- If the warning disappears, you may continue to drive the vehicle. If the warning remains shown or appears again, transmission oil leakage may be the cause. Contact an authorized dealer.

- **If the warning appears and the buzzer continues sounding:**

The clutch temperature is abnormally high.

If the warning appears while driving, perform the following:

- Select a lower gear than usual in the manual shift mode and start the engine.
- If the warning remains shown, stop the vehicle in a safe place and be sure to fully apply the parking brake.
- Place the gearshift lever in the "P" position. Depress the accelerator pedal to run the engine at a speed slightly higher than the idling speed in order to cool down the engine.
- If the warning disappears and the buzzer stops, you may continue to drive the vehicle. If the warning remains shown, contact an authorized dealer.

 **CAUTION**

Do not stop the engine without letting the transmission cool down, otherwise the transmission may seize up. Stop the engine only after the  warning has disappeared from the screen.

CRUISE CONTROL

Cruise control memorizes any desired speed above the speed indicated below and, maintains that speed automatically without having to operate the accelerator pedal. This is especially useful for free-way driving when there is little chance of having to pull over and stop.

Minimum speed for cruise control to function
--

Approx. 30 km/h (18 mph)

NOTE:

Do not operate the cruise control in the following driving conditions:

- *In heavy traffic which does not allow sufficient vehicle to vehicle distance*
- *On roads with sharp turns or poor visibility*
- *On icy, snow-covered, or otherwise slippery roads*
- *Steep downhill road*

The vehicle speed may become higher than the set speed on a steep downhill road. Turn off the cruise control if this occurs.

1 Controls and indicator

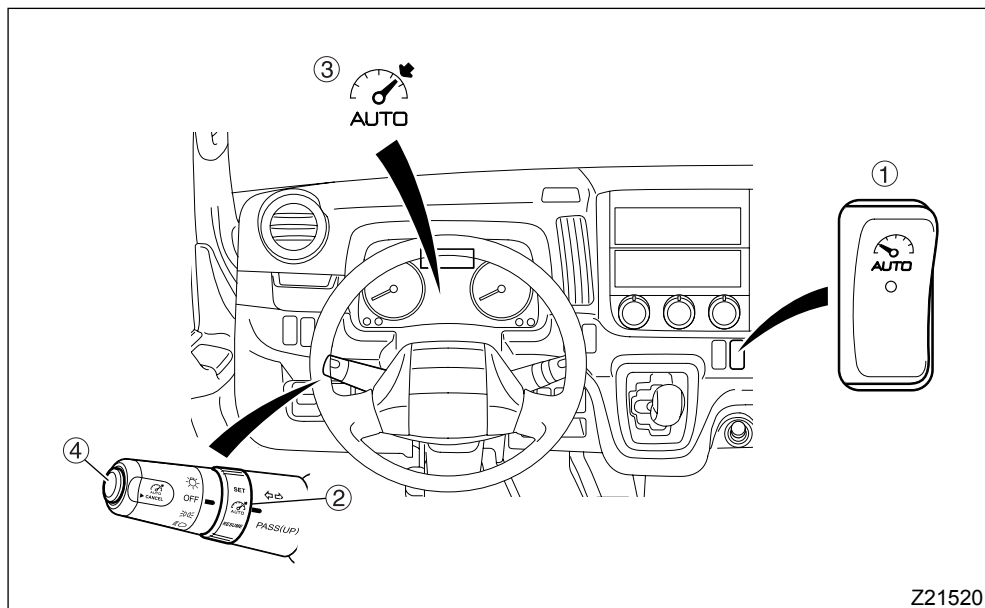

Z21520

① Main switch

This switch is used to activate and deactivate the cruise control function. The lamp inside the switch illuminates when the cruise control is on. The switch returns automatically to the normal position after having been pressed.

! WARNING

For safety, turn off the main switch when the cruise control is not in use.

② SET/RESUME switch

SET:

Turn this switch to set a desired speed and to reduce the set speed as well. The switch returns automatically to the normal position after having been turned.

RESUME:

Turn this switch to change the set speed to a higher speed and to return to the previously set speed as well. The switch returns automatically to the normal position after having been turned.

③ Cruise control indicator lamp

If the cruise control is activated, this lamp illuminates during driving.

④ Cancel switch

Press this switch to stop cruise control operation.

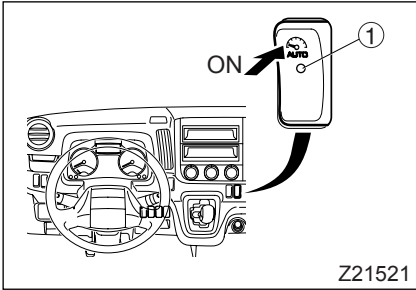
**2 To set a desired speed**

1. If your vehicle is equipped with an exhaust brake, check that the exhaust brake switch is in the "OFF" position. If the switch is in the "ON" position, place it in the "OFF" position. Press the ON side of the cruise control main switch. The lamp ① inside the switch will illuminate.

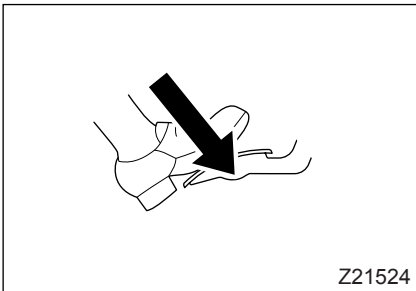

2. Depress the accelerator pedal until the desired speed is reached.

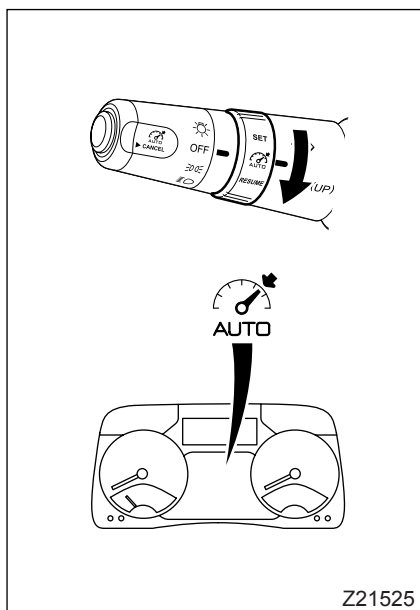

- When the desired speed is reached, turn the RESUME/SET switch toward the "SET" side. The  indicator lamp will illuminate indicating that the cruise control is activated. Now the desired speed is memorized, so release the accelerator pedal. The vehicle will maintain speed automatically.

NOTE:

- If you activate the cruise control while driving with the DUONIC® system in the manual shift mode, the DUONIC® system will switch to the automatic shift mode. When the DUONIC® system switches to the automatic shift mode, the multi-information display will show "D".
- Before pressing the ON side of the main switch to set a desired speed, make sure the exhaust brake switch is in the OFF position. You will not be able to set the speed if the exhaust brake switch is in the ON position. When driving with the cruise control active, exhaust braking can be used as usual, but the cruise control function will be deactivated while exhaust braking is being used.

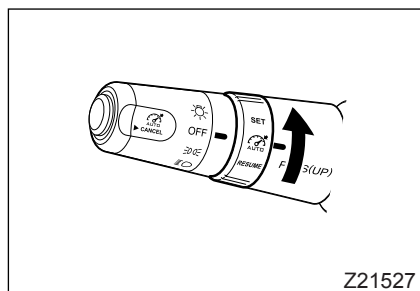

3 To increase the set speed in cruise control mode

- **By using the SET/RESUME switch**

Turn the SET/RESUME switch toward the "RESUME" side. The vehicle will accelerate. Release the switch when the desired speed is reached. The vehicle will cruise at the new, higher speed.

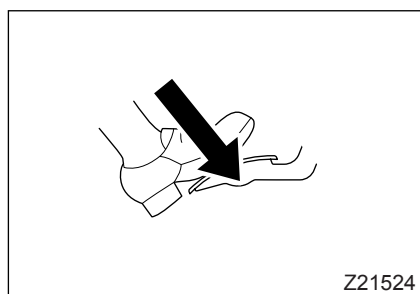

- **By using both accelerator pedal and SET/RESUME switch**

- Use the accelerator pedal to reach the desired speed.

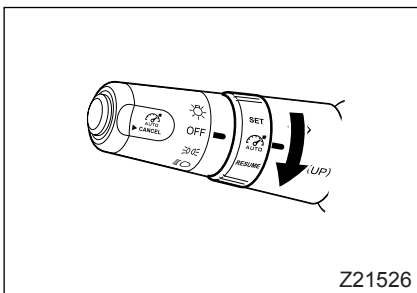

- When the desired speed is reached, turn the SET/RESUME switch to the “SET” side for 1 second or longer. The vehicle will then cruise at the new, higher speed.

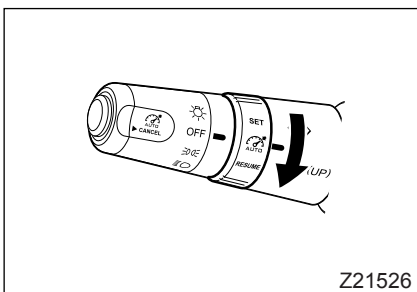

4 To decrease the set speed in cruise control mode

Turn the SET/RESUME switch toward the “SET” side. The vehicle will decelerate. Release the switch when the desired speed is reached. The vehicle will cruise at the new, lower speed.

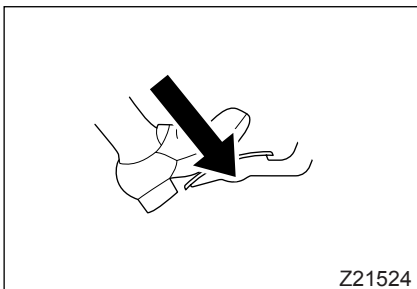

5 To accelerate temporarily in cruise control mode

Depress the accelerator pedal as you do in normal accelerating. When the pedal is released, the vehicle will cruise at the set speed again.

6 Automatic deactivation of the cruise control

The cruise control is deactivated automatically and the  indicator lamp also extinguishes in the following conditions:

- When the brake pedal is depressed
- When the exhaust brake* is activated
- When the gearshift lever is moved to any position other than “D”.
- When the vehicle speed varies more than 15 km/h (9mph) from the set speed (except at the time of operating the SET/RESUME switch).
- When the vehicle did not return to the set speed within 30 seconds after increasing the vehicle speed by depressing the accelerator pedal.

*: If equipped

! CAUTION

Placing the gearshift lever in the “N” position temporarily deactivates the cruise control. However, such practice is dangerous during driving because engine braking will no longer be possible. It will also cause malfunction of the transmission.

7 To reactivate the temporarily deactivated cruise control

- To reactivate the cruise control, turn the SET/RESUME switch toward the “RESUME” side. The  indicator lamp will illuminate again and the vehicle will resume running at the set speed.

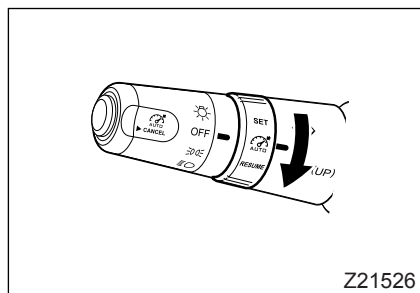
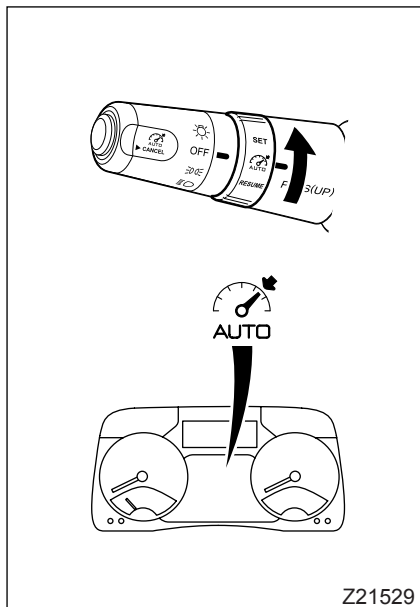

- To reactivate the cruise control while altering the set speed to a new speed, turn the SET/RESUME switch toward the “SET” side when the vehicle has reached the desired speed. The  indicator lamp will illuminate, and the vehicle will continue running at the set speed.

NOTE:

Under any of the following conditions, you cannot resume the set speed by performing the above operation. In these situations, perform the speed setting procedure from the beginning.

- The vehicle speed is lower than 30 km/h (18 mph).*

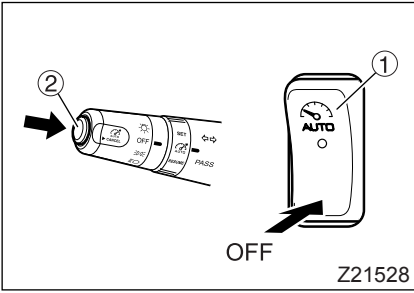

8 To deactivate the cruise control

Deactivate the cruise control by doing either of the following:

- Press the “OFF” side of the main switch ①.
- Press the cancel switch ②.

CAUTION

The cruise control cannot be deactivated if there is a problem with the engine control system. Do not use the cruise control when the  warning is displayed.

HAZARD WARNING LAMP SWITCH

CAUTION

Do not use the hazard warning lamps for an extended period of time while the engine is turned off. Doing so will drain the battery and make it impossible to start the engine.

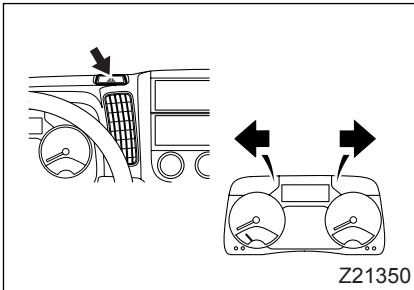

The hazard warning lamps may be used as a warning to other vehicles when you find it necessary to stop your vehicle in emergencies.

The lamps can flash in any of the starter switch positions.

Pressing the switch causes all of the turn signal lamps to flash simultaneously. At the same time, the indicator lamps  will start flashing.

Pressing the switch again causes the lamps to extinguish.

FRONT FOG LAMP SWITCH *

! CAUTION

Avoid using the front fog lamps unless visibility is poor, as they may prove distracting to other motorists during normal driving conditions.

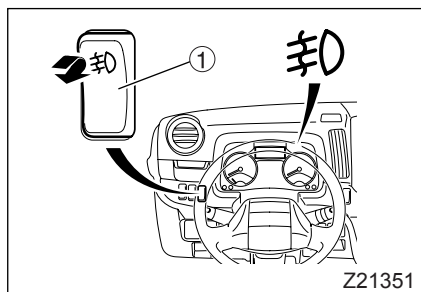

Use the front fog lamps when visibility is poor due to fog or snow.

The front fog lamps can be used with the lighting switch in the ☰ or ☷ position.

Pressing the front fog lamp switch ① lights the front fog lamps. At the same time, ☰ indicator lamp is illuminated.

The front fog lamps can be turned off by pressing the front fog lamp switch or by turning the lighting switch to the "OFF" position.

*: If equipped

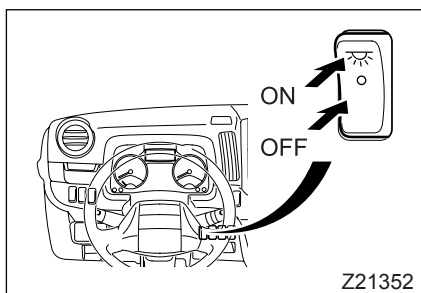

VAN BODY DOME LIGHT SWITCH

This switch operates the lighting inside the van body. With the starter switch in the "ON" position, pressing the "ON" side of this switch turns the van body interior lighting on. An indicator light comes on in the switch when the switch is in the "ON" position. Pressing the "OFF" side of this switch turns the lighting off.

! CAUTION

Leaving the van body interior lighting on for an extended period without the engine running can drain the battery.

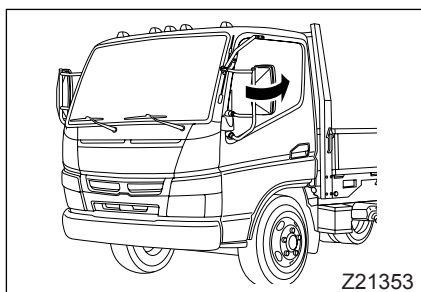

REARVIEW MIRRORS

The mirror can be swung manually in the direction indicated by the arrow.

Swing the mirror to the inward position if the mirror is obstructing free movement of the vehicle, for example, when turning a tight corner, passing an oncoming vehicle or parking in a narrow place.

WARNING

- During normal driving, the mirrors must be in their outward positions and adjusted so that clear rear views may be obtained through them.
- When turning right or left, bear in mind the difference in tracking of the front and rear inner wheels, and use the rearview mirrors to confirm safety behind you.
- Pay attention to the extended rearview mirrors when driving on narrow roads. Take particular care to ensure that they do not hit pedestrians.
- If rainy weather, drops of water can adhere to the mirrors, detracting from rearward visibility.
Stop the vehicle and wipe off the water to restore visibility.

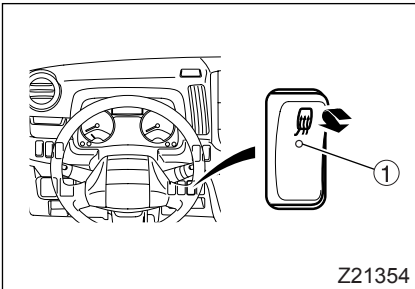

HEATED MIRROR SWITCH *

The mirror heaters can be used when the starter switch is in the "ON" position. If you press this switch when the mirrors are misted up, the heaters in the mirrors on both sides will operate to defog them. The lamp ① inside the switch will illuminate at this time. Press the switch again when the mirrors are clear. The heaters are automatically turned off in about 30 minutes if the switch is left on.

CAUTION

Do not use the mirror heaters unless the engine is running. Otherwise, the battery may discharge, making it impossible to start the engine.

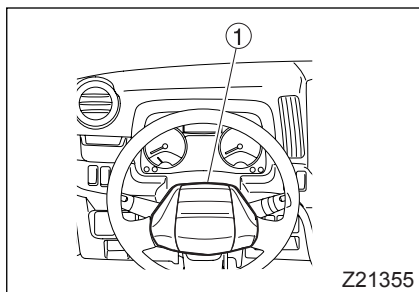

HORN SWITCH

Press the horn switch pad ① at the center of the steering wheel to sound the horn.

TRANSMISSION PTO *

! CAUTION

- Engage the PTO only with the engine running at idle.
- Pay careful attention to the  indicator lamp when using the PTO.

The engine output may dangerously change if the PTO is used for an extended time while the indicator lamp is flashing, which could lead to an accident.

If you find the indicator lamp flashing before using the PTO, first perform parked DPF regeneration and then engage the PTO. If the indicator lamp starts flashing during PTO operation, disengage the PTO and perform parked DPF regeneration before continuing the operation. ⇨  P. 5-57

- When using the PTO, never fail to engage the parking brake and place the gearshift lever in the “P” position. Placing the gearshift lever in the “P” position is important for safety although the PTO is operational also in the “N” position. Placing the gearshift lever in any position other than “P” or “N” is very dangerous as this will cause the vehicle to move and could lead to an accident.

Make sure the parking brake is firmly engaged and the gearshift lever is in the “P” position especially when using the PTO while controlling the engine from outside the vehicle.

- Be sure to disengage the PTO before driving. If you fail to disengage the PTO, the connected equipment/implement may be driven and could cause an accident. This could also damage the equipment/implement.

*: If equipped

- Depending on the type of device you connect to the PTO, please note that depressing the brake pedal during operation may reduce the speed of the engine.



NOTE:

- The transmission PTO delivers power taken from the truck's transmission to a hydraulic pump or other equipment/implement.
- Both automatic DPF regeneration and parked DPF regeneration do not work while the PTO is being used.
-  will appear and a buzzer will sound to warn you if you place the gearshift lever in any position other than "P" or "N" while the PTO is engaged or if you press the PTO switch while driving.

1 Control and indicators**① PTO switch**

Use this switch to engage and disengage the PTO.

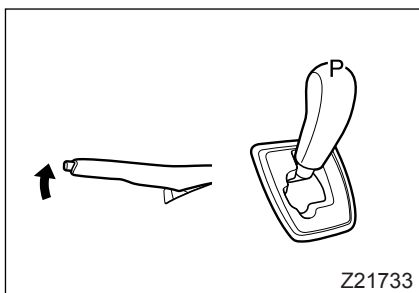
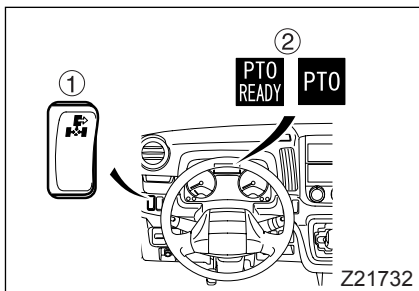

② Indicators displayed on multi-information display

-  is displayed while the transmission PTO is being engaged.
-  is displayed when the transmission PTO has been engaged.

**1.1 Engagement**

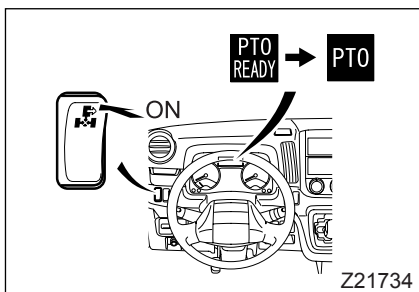
1. Confirm that the parking brake is firmly applied.
2. Confirm that the gearshift lever is placed in the "P" position.
3. Start the engine while depressing the brake pedal. After the engine has warmed up, let the engine idle.
4. Make sure the  indicator lamp is not flashing. If it is flashing, perform parked DPF regeneration before going to the next step.



5. Press the "ON" side of the PTO switch.
6. The multi-information display indicates . Once the PTO has been engaged, the indicator on the screen is replaced by .

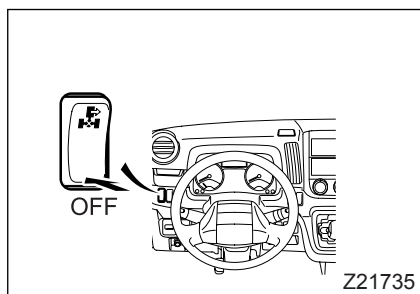

NOTE:

The  indicator may not appear under certain conditions. This does not indicate a problem.



1.2 Disengagement

Press the "OFF" side of the PTO switch.

The multi-information display indicates neither  nor .

BlueTec® SYSTEM

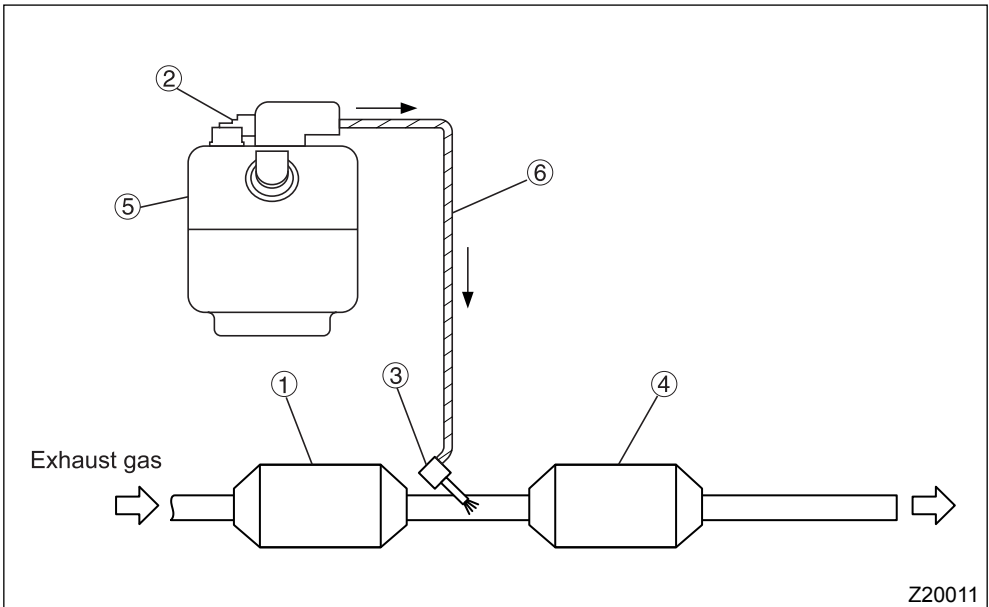

- ① **DPF muffler**
- ② **Pump module**
- ③ **Dosing module**
- ④ **Muffler with SCR/Oxidation catalyst**
- ⑤ **DEF tank**
- ⑥ **DEF tube**

NOTE:

- *BlueTec®*: A brand of Daimler AG
- *SCR* stands for "Selective Catalytic Reduction".
- The BlueTec® system is a combination of the regeneration controlling DPF system and the BlueTec® exhaust gas aftertreatment.
- The regeneration controlling DPF system collects particulate matter (PM) in exhaust gases with a ceramic filter located inside the muffler and burns the PM on the filter utilizing the effect of the front oxidation catalyst (continuous DPF regeneration).

- Continuous filter regeneration is impossible under certain conditions such as low-speed driving. Under these conditions, the system automatically raises the exhaust temperature to burn the PM to regenerate the filter (automatic DPF regeneration). However, even automatic DPF regeneration is sometimes impossible if the vehicle is repeatedly driven at very low speeds or starting and stopping the engine frequently during operation. The DPF must then be regenerated by burning the PM under manual control (parked DPF regeneration).
- The BlueTec[®] exhaust gas aftertreatment reduces nitrogen oxides (NO_x) by adding (spraying) Diesel Exhaust Fluid (DEF) to an area upstream of the selective catalytic reduction (SCR) catalyst using a device called the DEF doser to decompose NO_x into water and nitrogen gas.

1 Regeneration controlling DPF system

1.1 Controls and indicators

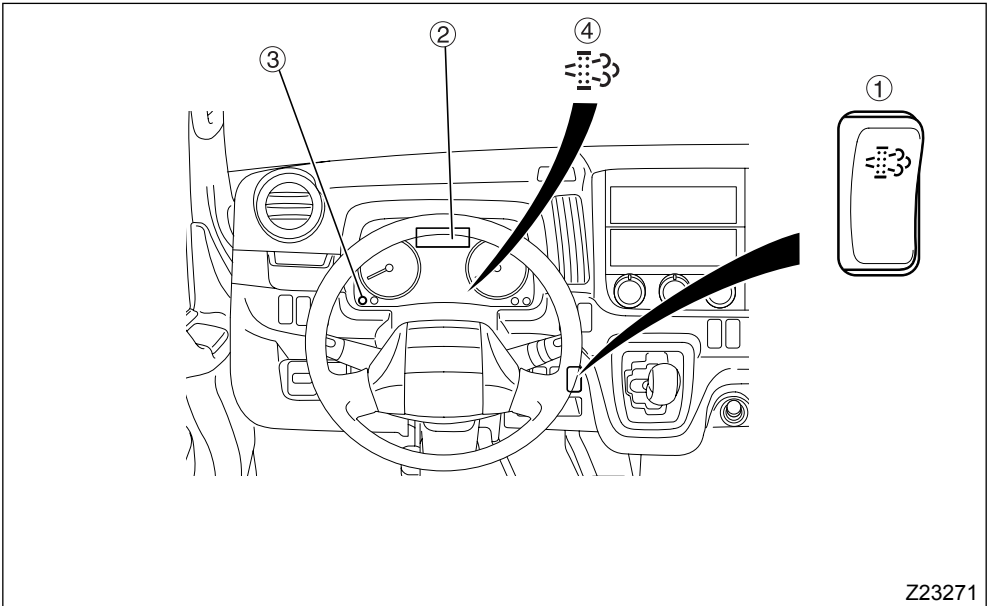

① **DPF cleaning switch**

Use this switch for parked DPF regeneration to burn PM in the DPF.

② **Multi-information display**

The multi-information display indicates the amount of PM in the DPF, a prompt for performing parked DPF regeneration, the predicted time until completion of parked DPF regeneration, and warnings.

③ **MODE switch**

Use this switch for selecting and setting indications on the multi-information display.

④ **DPF indicator lamp**

This lamp lights or flashes to indicate the state of the DPF.

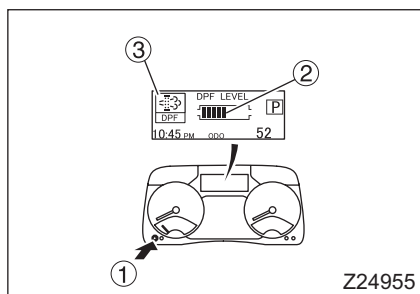

1.2 PM indicator

If you select the DPF monitor on the multi-information display, you can check the amount of PM collected in the DPF.

- Select the DPF monitor mode by pressing the MODE switch ① to see the PM indicator ②.
- The PM indicator shows the amount of PM in 9 degrees. The number of segments increases or decreases as the amount of PM changes. In addition, the color of the symbol ③ changes as follows:









Green: When the number of displayed segments is 1 to 6

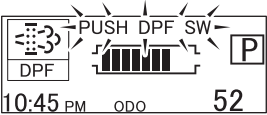

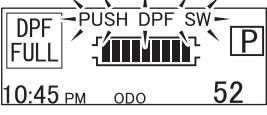

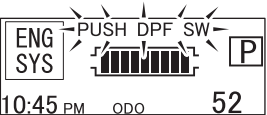
Amber: When the number of displayed segments is 7 to 9

1.3 PM indicator and warning/indicator lamp

- The PM indicator and warning/indicator lamp either light or flash according to the amount of PM in the DPF.
- Perform parked DPF regeneration if prompted by the warning/indicator lamp as well as by the PM indicator on the multi-information display.

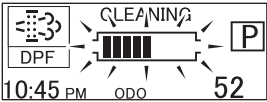
Indication by PM indicator	Warning/indicator lamp	Parked/automatic regeneration	Ref. page
<p>When the number of displayed segments is 1 to 6:</p> <p>Z24956</p>	-	-	-

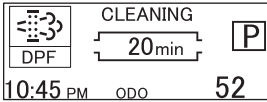
Indication by PM indicator	Warning/indicator lamp	Parked/automatic regeneration	Ref. page
<p>When the number of displayed segments is 7 or 8:</p>  <p style="text-align: right;">Z24957</p> <ul style="list-style-type: none"> • The “PUSH DPF SW” message flashes. • The  symbol turns from green to amber. 	<p>The  lamp (amber) flashes slowly (0.5-second intervals).</p>	<p>Perform parked DPF regeneration within 50 km (31 miles) or 1 hour, whichever earlier, after the lamp starts flashing.</p>	<p>5-57 5-58</p>
<p>When the number of displayed segments is 9:</p>  <p style="text-align: right;">Z24958</p> <ul style="list-style-type: none"> • The “PUSH DPF SW” message flashes. • The  warning appears. 	<p>The  lamp (amber) flashes quickly (0.25-second intervals).</p>	<p>Immediately stop the vehicle in a safe place and perform parked DPF regeneration.</p>	<p>5-57 5-58</p>
<p>When the DPF is overloaded with PM:</p>  <p style="text-align: right;">Z24959</p> <ul style="list-style-type: none"> • The “PUSH DPF SW” message flashes. • The  warning appears. 	<p>The  lamp (amber) flashes quickly (0.25-second intervals).</p>	<p>Immediately stop the vehicle in a safe place and perform parked DPF regeneration. The engine power is automatically reduced when the  warning appears.</p>	<p>5-57 5-58</p>

Indication by PM indicator	Warning/indicator lamp	Parked/automatic regeneration	Ref. page
<p>When automatic DPF regeneration is in progress:</p>  <p style="text-align: right;">Z24960</p> <ul style="list-style-type: none"> The "CLEANING" message is displayed. PM amount segments flash. 	<ul style="list-style-type: none"> The  lamp (green) illuminates. If a prompt for parked DPF regeneration has been issued following indication of 7 or more PM amount segments, the  lamp illuminates in green and amber alternately. 	Automatic DPF regeneration is in progress.	5-55
<p>When parked DPF regeneration is in progress:</p>  <p style="text-align: right;">Z24961</p> <p>The predicted time until completion of parked DPF regeneration is indicated.</p>	The  lamp (amber) illuminates.	Parked DPF regeneration is in progress.	5-57

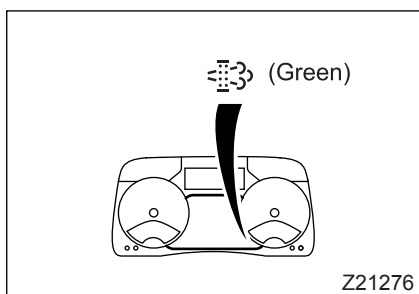

1.4 Automatic DPF regeneration



- If the DPF becomes so heavily loaded with PM that it cannot be regenerated by continuous DPF regeneration, the system initiates automatic DPF regeneration (regeneration by burning PM). The  indicator lamp (green) illuminates while the DPF is being regenerated by this method. You can operate the vehicle as usual even during automatic DPF regeneration although the engine operating sound will change due to the higher exhaust temperature.

- If you select the DPF monitor mode on the multi-information display during automatic DPF regeneration, the “CLEANING” message is displayed above the PM indicator, and the PM indicator flashes.

**WARNING**

If the vehicle must be stopped during automatic DPF regeneration, do so after checking that there are no flammable materials, such as dry grass or paper, near the exhaust pipe and muffler. As the exhaust gas as well as the exhaust pipe and muffler are extremely hot, nearby flammable materials could ignite and cause a fire.

NOTE:

- *During automatic DPF regeneration, the engine operating sound will change and, when the vehicle is stopped, the exhaust valve will be activated. These are normal conditions.*
- *Automatic DPF regeneration does not take place when the PTO is used. (Vehicles with a PTO)*
- *During automatic DPF regeneration when the  indicator lamp is flashing in amber (or the PM indicator is showing 7 or more segments), if you continue pressing the DPF cleaning switch until the lamp illuminates in amber, the system discontinues automatic DPF regeneration and initiates parked DPF regeneration.*
- *Automatic DPF regeneration does not occur while the  and  warnings (amber) are being displayed alternately.*

1.5 Parked DPF regeneration (performed following illumination of the (amber) indicator lamp)

The system sometimes cannot automatically remove the DPF trapped PM by oxidation, typically when you drive the vehicle at very low speeds or start and stop the engine frequently during operation. The system informs you of this condition by flashing the  (amber) indicator lamp to prompt you to manually remove the DPF trapped PM by burning. The flashing interval of the indicator lamp differs depending on the amount of the PM accumulated in the DPF.

NOTE:

If the vehicle is used in any of the following conditions, there will be a higher risk of automatic DPF regeneration not working, and so the indicator lamp will flash more frequently to prompt you to perform parked DPF regeneration.

- The vehicle is mainly driven at 20 km/h (12 mph) or lower speeds.
- Operation of the vehicle involves frequent starting and stopping of the engine at short intervals (less than 10 minutes).
- The vehicle is repeatedly driven for short distances (less than 10 km (6 miles)).
- The engine is used for such short times that it is shut off before having had time to warm up.

- Slow flashing (0.5-second interval)

You must use the DPF cleaning switch within 50 km (31 miles) or 1 hour of driving after the start of the flashing of the indicator lamp to perform the parked DPF regeneration in order to remove the PM inside the DPF by burning. If PTO is in use, stop work and perform the parked DPF regeneration.

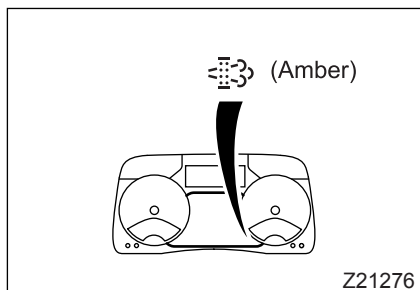



- Fast flashing (0.25-second interval)

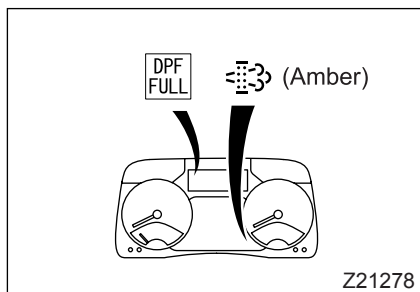

You must bring the vehicle to a stop in a safe place as soon as possible, then use the DPF cleaning switch to perform the parked DPF regeneration in order to remove the PM inside the DPF by burning.



 **CAUTION**

If the  (amber) indicator lamp flashes quickly or the  warning appears on the multi-information display, promptly perform parked DPF regeneration by using the DPF cleaning switch to remove PM in the DPF by burning. Continuing to drive with an overloaded DPF will result in system failure.

1.6 How to perform the parked DPF regeneration

The parked DPF regeneration steps you should perform upon flashing of the relevant indicator, warning and  (amber) indicator lamp are illuminated below. You may perform the parked DPF regeneration only when the  indicator lamp flashes. The parked DPF regeneration time is approximately 20 minutes although it varies with the conditions in which the vehicle is operated.

 **WARNING**

- Do not perform the parked DPF regeneration in a poorly ventilated garage or other closed area. Exhaust gas contains carbon monoxide, which is toxic and very dangerous.
- Keep all people away from the exhaust pipe and muffler.
- Prevent anyone from touching the exhaust pipe and muffler or being exposed to the exhaust gas.



 **CAUTION**

Avoid the following conditions or areas when performing parked DPF regeneration:

- Side gates or a tail gate is opened: Peripheral components may be damaged by the heat of the muffler.
- On painted road surfaces: Hot exhaust gas will discolor the paint.
- Near vegetation: It may be affected by the hot exhaust gas.
- Place with flammable materials, such as dry grass or paper: A fire may occur.

NOTE:

Parked DPF regeneration is not possible under the following conditions:

- *Within 30 seconds after starting the engine*
- *When the coolant indicator shows the temperature by up to 5 segments (Perform parked DPF regeneration after warming up the engine.)*
- *When the PTO switch is in the "ON" position (Vehicles with a PTO)*
- *When the engine speed is other than 800 rpm (idling speed).*
- *While the accelerator pedal or brake pedal is being depressed*
- *While the vehicle is moving*
- *When the gearshift lever is in any position other than "P" or "N"*
- *While the  and the  warnings (amber) are being displayed alternately.*

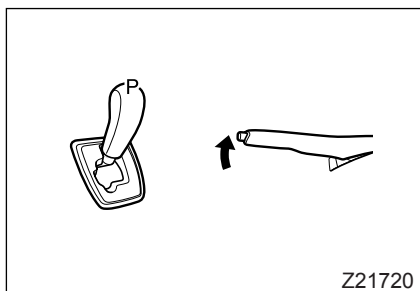

1. Park the vehicle in a safe place and warm up the engine.
2. Firmly engage the parking brake. Place the gearshift lever in the "P" or "N" position and then wait for at least 30 seconds.
3. If the air conditioner is operating, turn it off.
4. If your vehicle is equipped with a PTO, make sure the PTO is disengaged.
5. Confirm that the engine speed is at 800 rpm (idling speed).

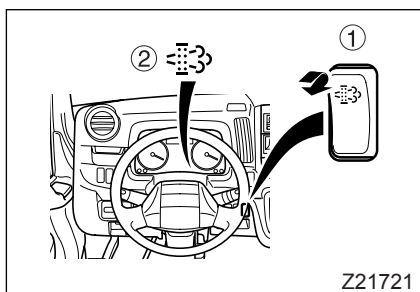

6. With the engine still in operation, continuously press the DPF cleaning switch ① until the  indicator lamp ② stops flashing and shifts to continuous illumination. The engine will increase its idling speed (to approx. 1,500 rpm) to start the parked DPF regeneration. When the parked DPF regeneration is started, the predicted time until completion of the regeneration is indicated on the multi-information display. The exhaust brake valve may also operate during the parked DPF regeneration.

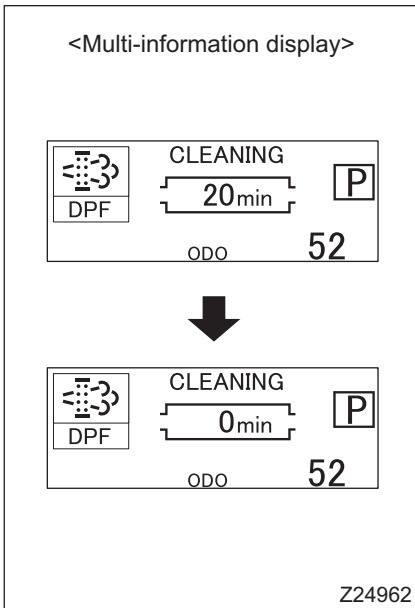

7. The predicted time indication shows a time near 0 minute, the idling speed of the engine returns to the original idling speed, and the  indicator lamp ② extinguishes.
8. Once the parked DPF regeneration is completed, you may drive the vehicle normally.
9. If you need to suspend the parked DPF regeneration before completion of the sequence, repress the DPF cleaning switch or depress the accelerator pedal.

NOTE:

- When you deliberately suspend the parked DPF regeneration, complete the remaining part of the sequence without delay by performing the above steps again.
- If the PM amount is indicated by 7 or more segments, you can start parked DPF regeneration even during automatic DPF regeneration by using the above method.

2 BlueTec® exhaust gas aftertreatment warnings

If the system detects an excessively low DEF level, an abnormality of the quality of DEF or an abnormality of the BlueTec® exhaust gas aftertreatment, the warning lamps will illuminate and blink, a buzzer will sound, and vehicle performance is automatically restricted.

2.1 DEF quantity warning

- If the DEF quantity in the tank becomes too low, the warning lamps will illuminate and blink, a buzzer will sound, and vehicle performance is automatically restricted. Be sure to add DEF well before it is used up.
- If the tank becomes empty, vehicle performance is automatically restricted so you can drive only at a low rate of speed.



CAUTION

Do not let the DEF tank become empty. If the tank becomes empty, the vehicle's operation is automatically restricted so you can drive only at a low rate of speed.

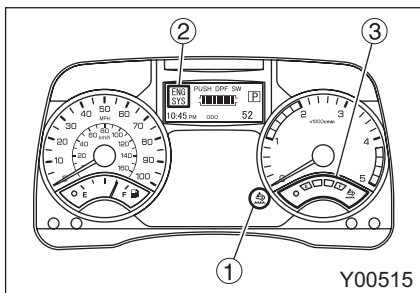

- 🔊 : Buzzer sounds
- ☀️ : Blinks
- ↔️ : Appears alternately

Warning level	1	2	3
Quantity of DEF	Too low	Little	Empty
① DEF warning lamp	-		
② Engine system warning	 (Amber)	 (Amber) (Red)	 (Amber) (Red)
Buzzer	-		Loud
③ DEF level indicator			
Normal driving	Engine power is reduced in stages.	Engine power is further reduced in stages.	Slow rate of speed. *

*: The driving restriction is engaged within 30 minutes after being set to the warning level 3. In addition, the driving restriction is engaged immediately if the fuel has been refueled, if the parking brake has been applied for approximately 5 minutes, or if the engine has been restarted. Transmission operates only in 1st gear, neutral or reverse gear selection and engine speed is limited, so the vehicle can only be driven at a slow rate of speed.

NOTE:

For the method for canceling the driving restriction, refer to the next page. ⇨ P. 1-11

2.2 Abnormal detection of DEF warning and BlueTec[®] exhaust gas aftertreatment fault warning

- If the system detects a deterioration in quality of the DEF due to the introduction of any fluid (water, low-density DEF, etc.) other than acceptable DEF, the warning lamps will illuminate and blink, a buzzer will sound, and vehicle performance is automatically restricted.
If this condition happens, turn the starter switch to the “LOCK” position to stop the engine and contact an authorized dealer immediately to have the degraded DEF drained and the vehicle inspected.
- If there is a problem with the BlueTec[®] exhaust gas aftertreatment, the warning lamps will illuminate and blink, a buzzer will sound, and a drive is restricted automatically. Immediately have the vehicle inspected by an authorized dealer.

CAUTION

If you continue to drive with the warning lamps illuminated and/or blinking and a buzzer sounding, the NO_x level of exhaust emissions will increase, damaging the environment. In addition, the BlueTec[®] exhaust gas aftertreatment will be damaged. Continuing to drive in this condition also results in reduced engine output and finally the engagement of vehicle performance restrictions after which the vehicle can only be driven at a slow rate of speed.

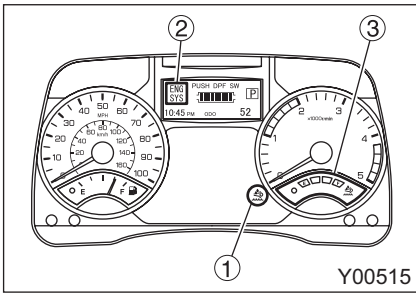

- : Buzzer sounds
- : Blinks
- : Unilluminated
- : Appears alternately

Warning level		1	2	3
① DEF warning lamp				
② Engine system warning				
Buzzer		-		Loud
③ CASE 1	Any fluid other than acceptable DEF is introduced. (DEF quality deterioration)			
③ CASE 2	The BlueTec® exhaust gas aftertreatment has a fault.			
Normal driving		Engine power is reduced in stages.	Engine power is further reduced in stages.	Slow rate of speed. *
CASE 1: Abnormal detection		1hour later	2hours 30minutes later	
CASE 2: Abnormal detection		1hour later	3hours 30minutes later	

*: The driving restriction is engaged within 30 minutes after being set to the warning level 3. In addition, the driving restriction is engaged immediately if the fuel has been refueled, if the parking brake has been applied for approximately 5 minutes, or if the engine has been restarted. Transmission operates only in 1st gear, neutral or reverse gear selection and engine speed is limited, so the vehicle can only be driven at a slow rate of speed.

NOTE:

- *If the system detects an abnormality again within 40 hours, the system is set to the warning level 3 immediately and the driving restriction is engaged.*
- *The  warning lamp may also illuminate if the engine is started when the system has abnormality.*

3 Inspection and maintenance precautions**• DEF dosing system**

The DEF dosing system (pump module plus dosing module) continues to operate for about 2 minutes after the starter switch has been put in the “LOCK” position. Wait for at least 2 minutes before disconnecting the battery and electrical system connectors in order to carry out an inspection, maintenance and so on.

• Muffler

Each muffler has a built-in catalyst and ceramic filter.

**WARNING**

Do not touch the water that comes out from the muffler. The water is weakly acidic because of the action of the catalyst inside the muffler. If it comes in contact with your skin, wash it off with lots of water.

! CAUTION

- Do not kick or strike the muffler because you may damage the catalyst and/or the ceramic filter.
- Depending upon the way in which the vehicle is used, a large amount of rust may be generated from the exhaust pipe and the suspension bracket, even at an early stage. Visually inspect the muffler, and if there is any abnormality, contact an authorized dealer and have the vehicle inspected.
- It is a violation of federal law to alter exhaust pipe, aftertreatment system, or other emission-related components, in any way that would bring the engine/vehicle out of compliance with certification requirements.
- Clean the dosing module cover ① if found to be heavily clogged with mud. If mud is left deposited, the dosing module can not cool down, and the BlueTec® will not work effectively. Clean it at regular intervals by using a brush or similar tool.

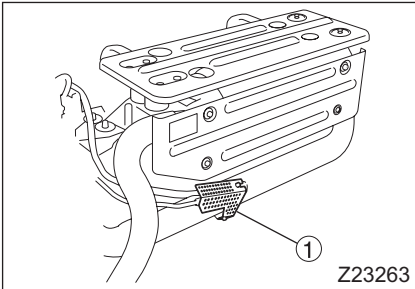
**NOTE:**

Because the exhaust gas is cleaned before it is emitted, the odor of the exhaust gas will be different from that of a conventional diesel vehicle.

IDLE LIMITING SYSTEM *

The idle limiting system is a system designed to automatically stop the engine when the vehicle has been parked for a certain period of time.

- The  warning appears (red) and the buzzer sounds for a specific period of time after the vehicle is stopped. The engine then stops automatically after a specific period of time has been reached.
- Turn the starter switch to the “LOCK” position once and then restart the engine.

**WARNING**

Do not coast down a hill with the engine stopped automatically. Doing so will make steering actions heavy and braking extremely sluggish, which could lead to a serious accident.

**CAUTION**

- **Before leaving the driver's seat, turn the starter switch to the “LOCK” position and apply the parking brake properly. Remove the starter key when leaving the vehicle. The idle limiting system is an auxiliary device that prevents the vehicle from idling for long periods of time.**
- **Remove the starter key before inspecting the vehicle. Otherwise the idle limiting system may operate and cause an unexpected accident.**

NOTE:

- *If the engine is going to be stopped for a long time, be sure to place the starter switch in the "LOCK" position to prevent deterioration of battery performance.*
- *The idle limiting system will not operate under the following conditions.*
 - *When the engine speed is 900 rpm or more*
 - *When the gearshift lever is in a position other than "P" or "N"*
 - *When the vehicle is moving*
 - *When the accelerator pedal or brake pedal is being depressed*
 - *When the DPF is in automatic regeneration or parked regeneration*
 - *When the PTO is connected*

6. INSTRUMENT AND WARNING LAMPS

INSTRUMENT AND WARNING LAMP LOCATIONS	6-2
SPEEDOMETER	6-2
TACHOMETER	6-2
COOLANT TEMPERATURE GAUGE	6-3
FUEL GAUGE	6-4
DEF LEVEL INDICATOR	6-5
MULTI-INFORMATION SYSTEM	6-6
WARNING/INDICATOR TELLTALE	6-21
WARNING/INDICATOR LAMPS	6-28

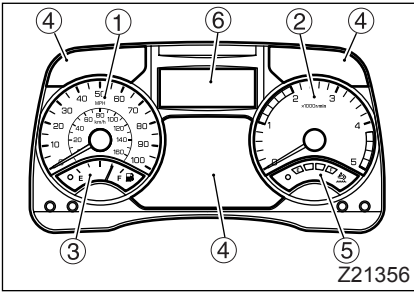

INSTRUMENT AND WARNING LAMP LOCATIONS

- ① Speedometer
- ② Tachometer
- ③ Fuel gauge
- ④ Warning/indicator lamps
- ⑤ DEF level indicator
- ⑥ Multi-information display

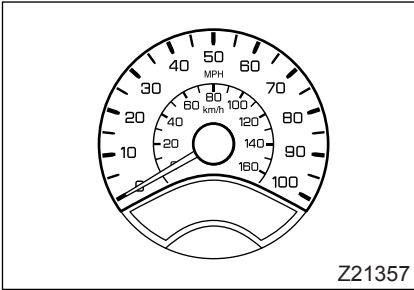

SPEEDOMETER

The speedometer indicates vehicle speed in miles or kilometers per hour.

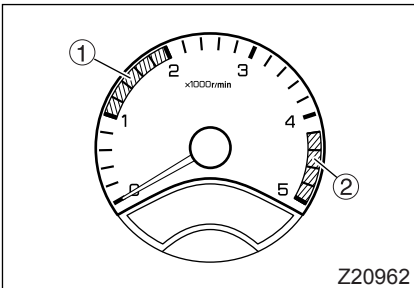

TACHOMETER

- The tachometer indicates engine speed in revolutions per minute.
- The green zone ① indicates the engine speed that is a rough guide for economic operation.
- If the needle enters the red zone ②, the engine is overrevved. Reduce the vehicle speed sufficiently during downhill driving or downshifting to keep the needle from entering this zone.





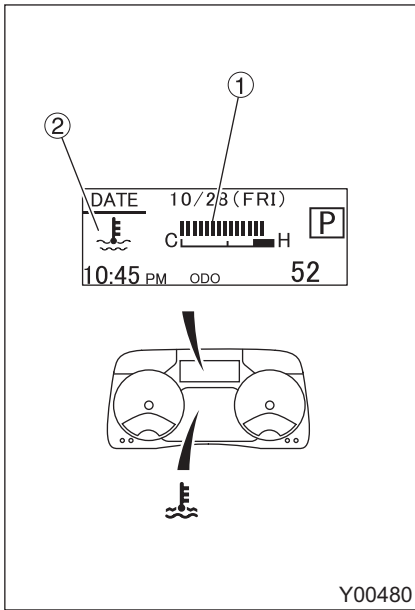

⇒ P. 7-12

CAUTION

The term “overrev” refers to rotation of the engine at an RPM exceeding the maximum limit. This occurs when the engine is driven by the wheels during downhill driving or downshifting. Persistent overrevving can lead to an engine breakdown.



COOLANT TEMPERATURE GAUGE

- The coolant temperature gauge is displayed on the multi-information display and indicates the temperature of the engine coolant.
 - With the engine running normally, the coolant temperature indicator ① will indicate around the middle point of the scale.
 - If the coolant temperature becomes abnormally high, the multi-information display ② will indicate  in amber. The vehicle can still be driven.
 - If the coolant temperature becomes even higher, the  indication on the multi-information display will change from amber to red and the  warning lamp will appear. The engine power will be reduced, but the vehicle can still be driven.
 - If the engine overheats, the  indication (red) on the multi-information display and  warning lamp will stay shown and a buzzer will sound.
- When the engine has overheated, perform the checks and corrective steps described on this reference page:  P. 13-8

CAUTION

If the engine overheats, be sure to stop the engine only after letting it run at a speed slightly above the idling RPM until the coolant cools down. Turning off the engine immediately after stopping will cause the coolant temperature to rise quickly and may cause the engine to seize up.

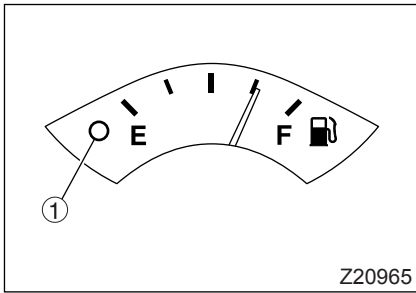

FUEL GAUGE

The fuel gauge indicates the amount of fuel still remaining in the fuel tank.

F: Full
E: Empty

When the Low-fuel warning lamp ① is illuminated, the approximate quantity of fuel remaining in the tank is as indicated below.

Quantity of fuel remaining in tank	
Tank capacity	Quantity
113 liters (29.8 gallons)	Approx. 15 liters (4 gallons)
125 liters (33 gallons)	Approx. 17 liters (4.5 gallons)

When the needle approaches the “E” mark or Low-fuel warning lamp is illuminated, refuel as soon as possible.

If the vehicle completely runs out of fuel, air must be bled out of the fuel system. ⇒ P. 13-31

CAUTION

Be careful not to allow the engine to run out of fuel. Engine stall resulting from an empty tank could cause damage to the fuel injection system.

NOTE:

If the vehicle runs out of fuel, air will enter the fuel system. Simply refueling the vehicle will not make the engine startable ; the air must be bled out of the fuel system. ⇒ P. 13-31

DEF LEVEL INDICATOR

CAUTION

Do not let the DEF tank become empty. If the tank becomes empty, the vehicle's operation is automatically restricted, so you can drive only at a low rate of speed.

We recommend carrying an additional container of DEF in your vehicle in case the DEF tank becomes empty.

1 DEF level indicator

- The DEF level indicator lamp ① shows the level of the DEF in the DEF tank.
 F (all 4 segments are lit): Full
 E (only 1 segment is lit): Replenishment required
 E (all 4 segments are flashing): Empty

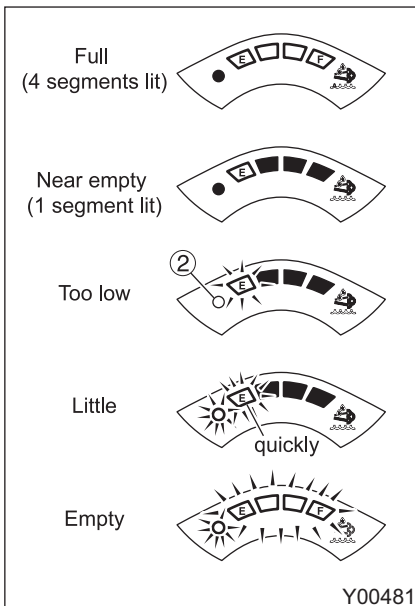
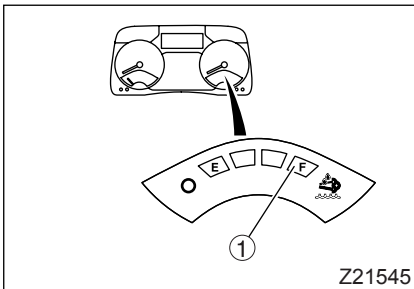

- When the tank is full of DEF, all 4 segments of the DEF level indicator are illuminated. As the DEF level drops, the segments go out one by one.
- If only the E segment of the DEF level indicator is illuminated, the quantity of DEF has fallen to an unsafe level. You should then replenish the tank with DEF. ⇨ P. 1-9
- When the DEF becomes low, the E segment will flash and the DEF level warning lamp ② will illuminate, and when it becomes even lower, the E segment will flash faster and the DEF level warning lamp will flash. When the DEF tank becomes empty, all segments will flash. When DEF becomes empty, the driving restriction is engaged and only low-speed driving will be possible, so refill the DEF before it becomes empty. For more information, see page 5-61.

MULTI-INFORMATION SYSTEM

1 Outline of multi-information system

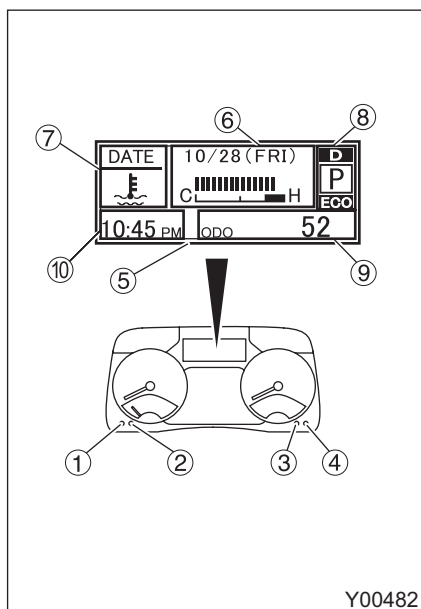

- ① MODE switch
The MODE switch is used to select the displayed information.
- ② SELECT switch
The SELECT switch is used to switch display settings for the item that have been selected with the MODE switch.
- ③ SET/RES switch
The SET/RES switch is used to configure the selected item (e.g. values, etc.) on the screen.
- ④ ODO/TRIP switch
The ODO/TRIP switch is used to switch between the odometer (total distance driven) and the trip meter (distance driven from a selected point to the present point).
- ⑤ Multi-information display
The multi-information display shows the following details ⑥ to ⑩.
- ⑥ Information area
The information area shows various types of vehicle information. ⇒ P. 6-7
- ⑦ Warning/indicator area
The warning/indicator area shows various warnings and indicators. ⇒ P. 6-21
- ⑧ Transmission information area
The transmission information area shows gear positions selected by the DUONIC® system and other transmission-related information. ⇒ P. 5-21
- ⑨ Odometer/trip meter area
The odometer/trip meter area shows the odometer and the trip meter. ⇒ P. 6-7
- ⑩ Time/outside temperature area (outside temperature indication is available for vehicles with a fully automatic air conditioner)
The time/outside temperature area can show the time. If the vehicle has a fully automatic air conditioner, this area can also show the outside temperature. ⇒ P. 6-11

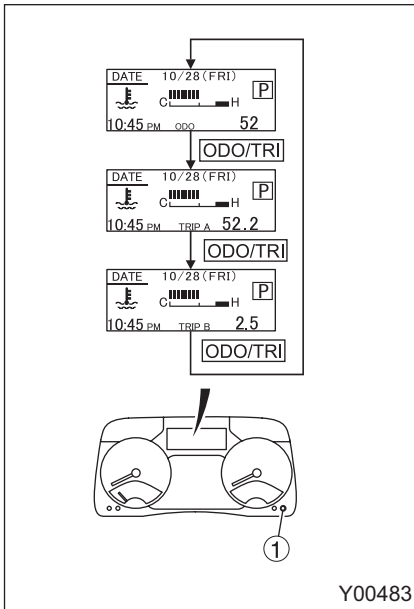

2 Odometer/trip meter

When the starter switch is turned to “ON”, either “ODO” (odometer) or “TRIP” (trip meter) is displayed. The display toggles between “ODO” and “TRIP” each time the ODO/TRIP switch ① is pressed.

- **ODO (odometer)**

Indicates the total distance driven by the vehicle to the nearest mile.

- **TRIP (trip meter)**

Indicates the distance driven by the vehicle from a selected point to the present point to the nearest 0.1 mile.

The trip meter has two options: TRIP “A” and TRIP “B”. The indications are independent of each other. To reset the trip meter to zero, press the ODO/TRIP switch for at least 1 second. The count of only the currently displayed option will return to “0.0”.

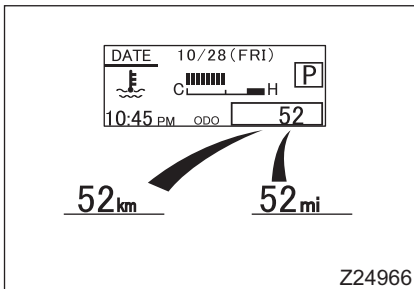

NOTE:

If the unit of fuel mileage is changed, the unit for the odometer and trip meter indication changes accordingly. For information on the fuel mileage display unit, see page 6-13.

3 Display mode selection and settings

You can select a desired display mode by pressing the MODE switch ⑦.

Display modes

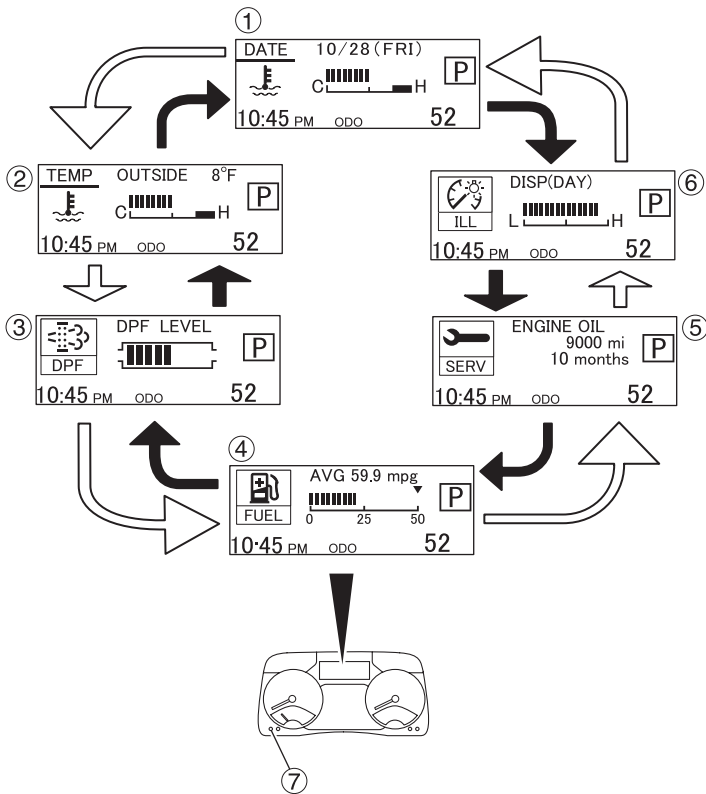

◀ : Short press (up to 1 second) on MODE switch

◀ : Long press (1 second or longer) on MODE switch

Y00484

No.	Display mode	Ref. page
①	Calendar	6-9
②	Outside air temperature (vehicles with fully automatic air conditioner)	6-11
③	DPF monitor	6-12
④	Fuel mileage information	6-13
⑤	Maintenance information	6-15
⑥	Illumination intensity (brightness adjustment)	6-19

3.1 Calendar and clock

Press the MODE switch ① to display the date on the screen.

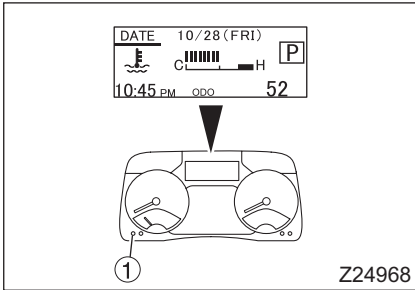

If you press the SELECT switch ② while the date is displayed on the screen, the month part of the date will change from numerical representation to English representation.

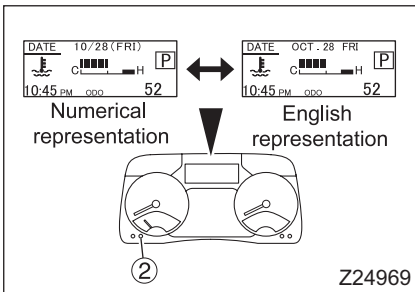

- Date and time adjustment

Example: 12-hour clock

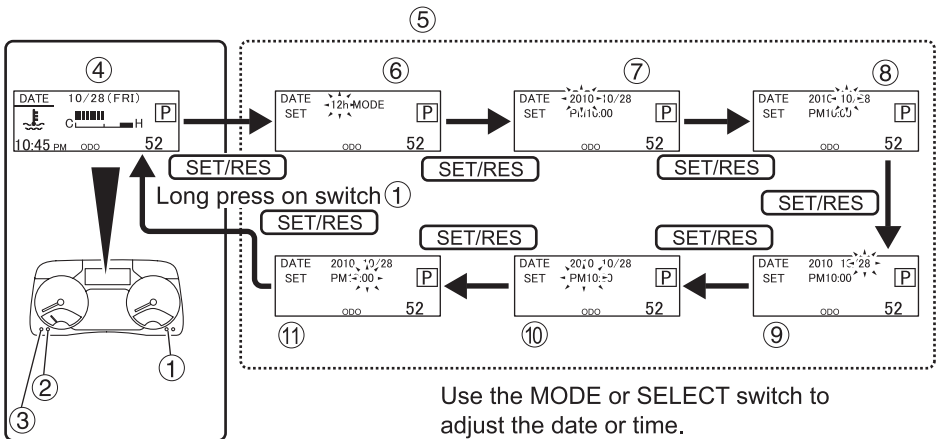

1. Press and hold the SET/RES switch ① while the calendar mode ④ is displayed on the screen until the adjustment screen ⑤ appears.
2. Each time you press the SET/RES switch, one of the indication items is selected in the sequence shown below with the selected item flashing. The cycle repeats if you press the switch repeatedly.

Initial display screen (calendar mode) ④ → Time display mode ⑥ → Year ⑦ → Month ⑧ → Day ⑨ → Hour ⑩ → Minute ⑪ → Initial display screen

While the item you want to set is flashing, press the MODE switch ③ or SELECT switch ② to make adjustments.

- The 12-hour clock will be displayed if you select “12 h” on the time display mode screen; selecting “24 h” will change the display to the 24-hour clock.
 - Press the SELECT switch to adjust the indication. Each long press (0.5 second or longer) will move the value forward by 2 years, 2 months, 2 days, 2 hours, or 10 minutes.
 - Press the MODE switch to retard the indication. Each long press (0.5 second or longer) will move the value backward by 2 years, 2 months, 2 days, 2 hours, or 10 minutes.
3. After completing necessary adjustments, press the SET/RES switch.
 4. Press the SET/RES switch as many times as necessary to go back to the initial display screen.

- **Adjusting the clock to time signals**

While the display is in the calendar mode, you can adjust the clock to a time signal by pressing the SET/RES switch and releasing the switch simultaneously with a time signal.

Example:

The clock will be adjusted to 11:00
if its current indication is between 11:00 and 11:29.

The clock will be adjusted to 12:00
if its current indication is between 11:30 and 11:59.

NOTE:

- *If the date is set, the day of the week will be automatically adjusted to the new date.*
- *The calendar can be adjusted for the period between January 1, 2009 and December 31, 2039.*

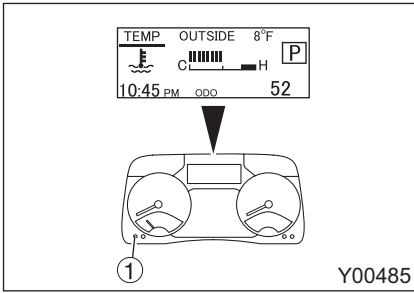

3.2 Outside air temperature <vehicles with fully automatic air conditioner>

If you select the outside air temperature mode by pressing the MODE switch ①, the outside air temperature around the front of the cab is indicated.

NOTE:

As the temperature is sensed at the outside air inlet on the cab, the indicated temperature may differ from the actual outside air temperature under certain traffic or air conditioner operating conditions.

- The following selections and settings are possible for the outside air temperature mode:
 - Selecting the unit of temperature display between degree Fahrenheit (°F) and degree Celsius (°C)
 - Selecting the bottom-left display on the screen between temperature and time
 - Setting an alarm when the outside air temperature falls below a preset temperature
- **Selections and settings in outside air temperature mode**

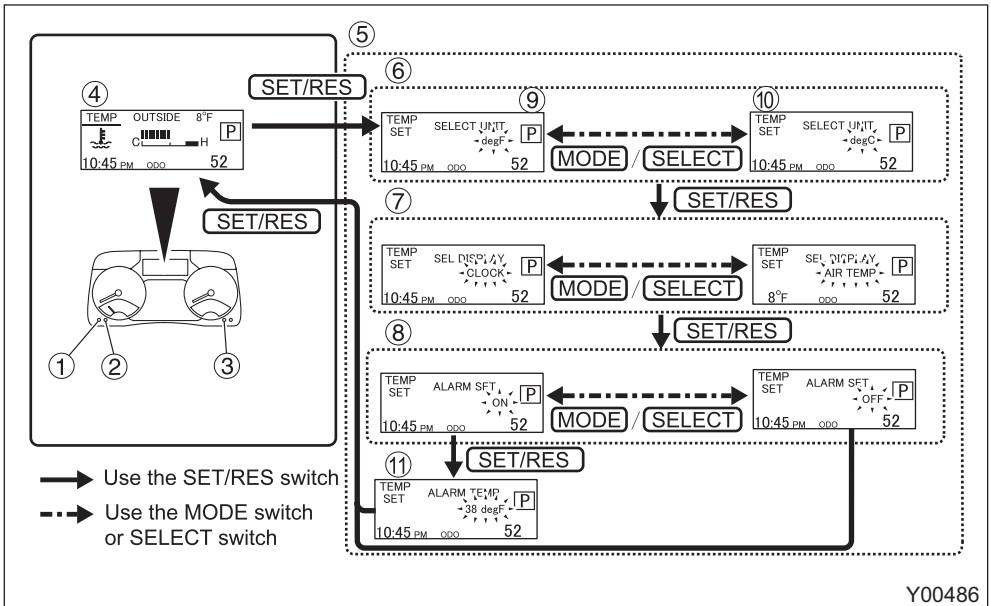

1. Select the outside air temperature mode ④ by pressing the MODE switch ①.
Press and hold the SET/RES switch ③ to display the adjustment screen ⑤.
2. Select the adjusting/setting item using the SET/RES switch. Each time you press the SET/RES switch, the display changes in the following sequence:
Temperature unit selection ⑥ → Time/temperature selection ⑦ → Temperature alarm on/off setting ⑧
 - The temperature unit can be changed between degree Fahrenheit (°F) ⑨ and degree Celsius (°C) ⑩ by pressing the MODE switch or SELECT switch ② on the temperature unit selection screen ⑥.
 - The bottom-left display can be changed between temperature and time by pressing either the MODE switch or SELECT switch on the time/temperature selection screen ⑦.
 - Method for setting temperature alarm on/off
On the temperature alarm on/off setting screen, press the MODE switch to activate the outside air temperature alarm and press the SELECT switch to deactivate the alarm. Once the alarm is activated, you can set an alarm temperature between 23°F and 41°F ⑪ (–5°C and 5°C). The alarm is issued by the temperature indication at the bottom-left on the screen flashing for about 1 minute when the set temperature is reached.

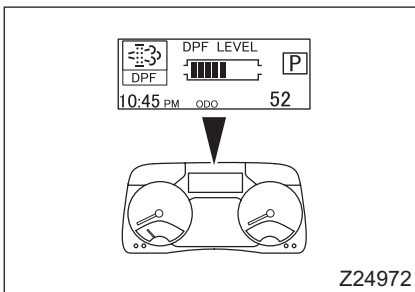

3.3 DPF monitor

This display mode indicates the amount of PM in the DPF, a prompt for performing parked DPF regeneration, and the predicted time until completion of parked DPF regeneration. If the situation requires, the DPF monitor also provides the driver with necessary warnings and indications.

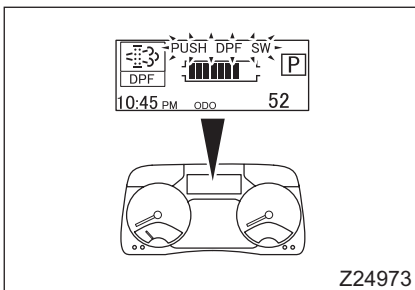

- If the DPF contains PM equivalent to 7 or more segments of the indicator, a message is displayed prompting you to perform the parked DPF regeneration.

See page 5-52 for details about the DPF.

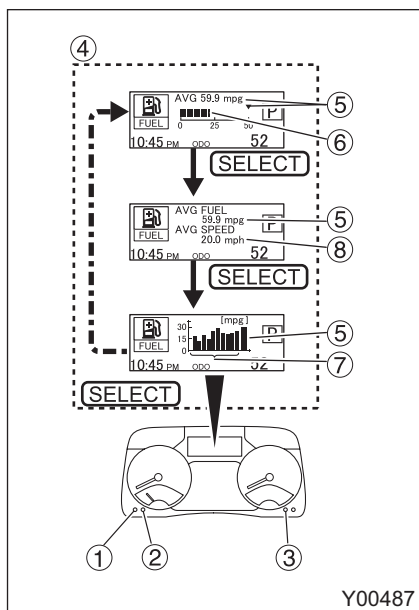

3.4 Fuel mileage information

The fuel mileage information includes: average fuel mileage ⑤, real-time fuel mileage ⑥, instantaneous fuel mileage ⑦, and average speed ⑧.

- The average fuel mileage indicates the average of the fuel mileage from the time it was last reset to the present.
- The real-time fuel mileage indicates the fuel mileage in the last 0.5-second period.
- The average vehicle speed indicates the average speed at which the vehicle has been driven since the last reset.
- The instantaneous fuel mileage is the fuel mileage over the past 1-minute period.

• How to switch the display

1. Press the MODE switch ① to select the fuel mileage information mode ④.
 2. Press the SELECT switch ② to change the display. Each time you press the SELECT switch, the following pairs of information will be displayed one after another.
- Average mileage and real-time mileage
 - Average mileage and average vehicle speed
 - Instantaneous mileage and average mileage

• How to reset the mileage and speed data

You can reset both the average vehicle speed and average mileage data by pressing and holding (1 second or more) the SET/RES switch ③.

• Adjusting the correction coefficient for fuel mileage data and selecting the unit of fuel mileage display

If necessary, you can change the correction coefficient for fuel mileage data and the unit of fuel mileage display as follows.

- Usually, there is no need to change the correction coefficient for fuel mileage data. However, the coefficient should be changed if you notice any significant difference between the actual and indicated fuel mileages. Increasing the correction coefficient value will result in larger indications for all of the average, real-time, and instantaneous fuel mileages. Reducing the value decreases them.

Default value of correction coefficient	1.00
---	------

NOTE:

If you press and hold the SET/RES switch for more than 1 second in the correction coefficient change screen, the coefficient will return to the default value (1.00).

- The fuel mileages can be indicated in units of “mpg”, “km/l”, or “l/100 km”.
 - “mpg” indicates the miles covered by the vehicle on one gallon of fuel.
 - “km/l” indicates the kilometers covered by the vehicle on one liter of fuel.
 - “l/100 km” indicates the amount of fuel in liters that the vehicle has consumed to cover a distance of 100 kilometers.

NOTE:

If the unit for fuel mileage is changed, the unit for the odometer and trip meter indication changes accordingly.

- If “km/l” or “l/100 km” is selected, the unit for the odometer and trip meter indication becomes “km”.
- If “mpg (USA)” or “mpg (UK)” is selected, the unit for the odometer and trip meter becomes “mi (mile)”.

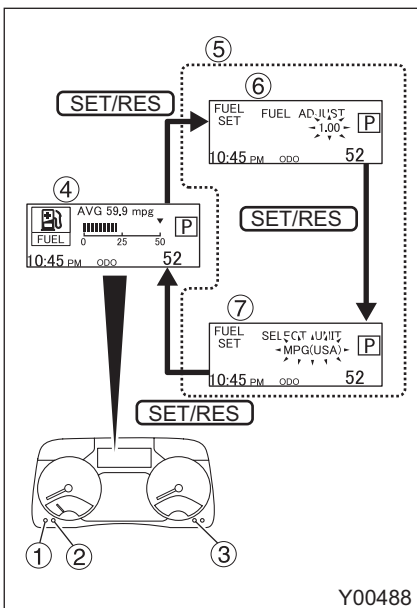

Y00488

1. Press the MODE switch ① to select the fuel mileage information mode ④.
2. Press the SET/RES switch ③ to display the adjustment screen ⑤, then press the SET/RES switch. Each time you press the switch, the display toggles between the fuel mileage correction coefficient (FUEL ADJUST) ⑥ and the fuel mileage unit (SELECT UNIT) ⑦.
3. With the desired display selected, press the SELECT switch ② or MODE switch to change the correction coefficient or fuel mileage unit.
 - Press the SELECT switch to increase the correction efficient, or the MODE switch to decrease it. Continue to press each switch if you want to change the value quickly.
 - Use the SELECT switch to change the fuel mileage unit. The unit changes in the following sequence each time you press the switch: “mpg (USA)” → “mpg (UK)” → “km/l” → “l/100 km”
4. Press the SET/RES switch to return to the initial display screen.

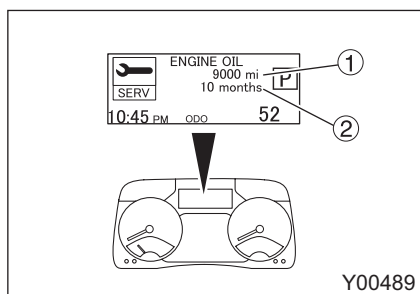

3.5 Maintenance information

If you select this mode, the multi-information display indicates the running distance ① and the number of months ② since the distance was last reset after replacing oils, fluids, or filter elements according to your selection of screen.

- Selection of maintenance information screens

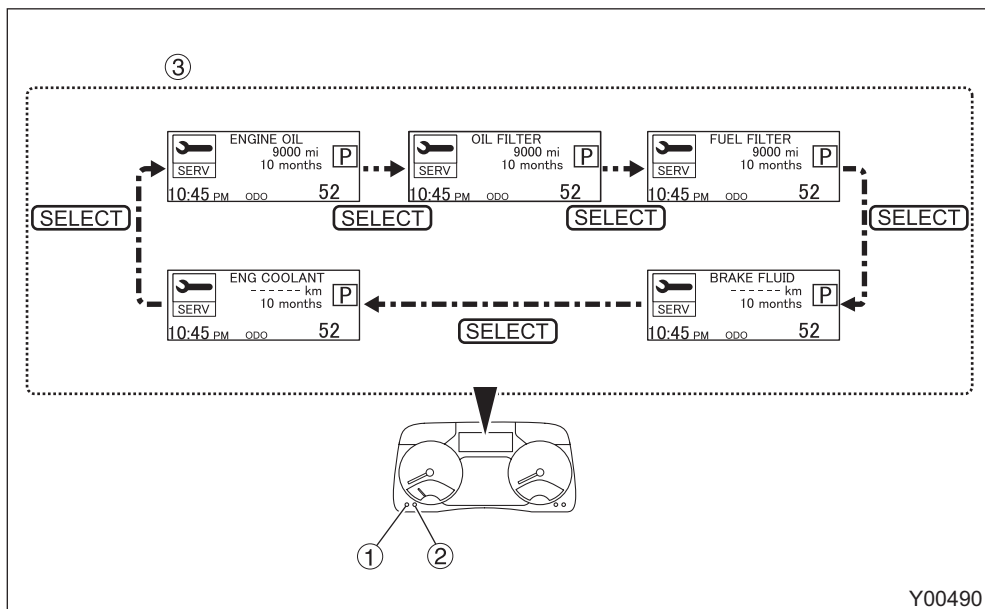

1. Press the MODE switch ① to select the maintenance information mode ③.
2. Press the SELECT switch ②. Each time you press the switch, the screen changes to the one for a new replacement item in the following sequence, beginning with the previously displayed screen:
ENGINE OIL → OIL FILTER (engine oil filter) → FUEL FILTER → BRAKE FLUID → AIR FILTER → T/M OIL (transmission oil and clutch control fluid) → HUB GREASE (wheel hub bearing grease) → DIFF OIL (differential oil) → P/S OIL (power steering oil) → ENG COOLANT (engine coolant)

- **How to set replacement intervals**

Set the replacement interval for each replacement item according to the table below.

Item	Replacement interval
Engine oil	Every 16,000 km (10,000 miles) or every 12 months (Every 8,000 km (5,000 miles) at the severe condition *1)
Engine oil filter (OIL FILTER)	Every 16,000 km (10,000 miles) or every 12 months
Fuel filter (FUEL FILTER)	Every 32,000 km (20,000 miles) or every 12 months
Brake fluid	Every 24 months
Air filter	Every 32,000 km (20,000 miles)
Transmission oil and clutch control fluid (T/M OIL)	Every 64,000 km (40,000 miles)
Wheel hub bearing grease (HUB GREASE)	Every 48,000 km (30,000 miles) or every 24 months (Every 48,000 km (30,000 miles) or every 12 months at the severe condition *2)
Differential gear oil (DIFF OIL)	Every 64,000 km (40,000 miles)
Power steering oil (P/S OIL)	Every 32,000 km (20,000 miles) or every 12 months
Engine coolant (ENG COOLANT)	Every 24 months

NOTE:

*1: Severe condition type (A)~(C)

*2: Severe condition type (D)~(K)

For about severe conditions type, refer to page 15-2.

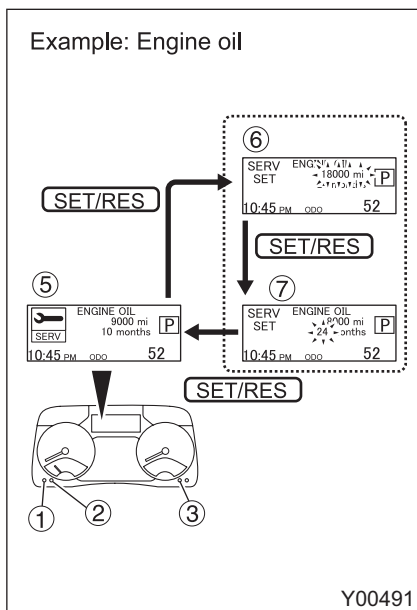

1. Press the MODE switch ① to select the maintenance information mode ⑤.
2. Press the SELECT switch ② to select the screen for the replacement item for which you want to set the interval.
3. Press the SET/RES switch ③ to select the interval distance setting screen ⑥ (with "mi" indicated). The numerals indicating the distance blink once this screen is selected.
4. Press the SELECT switch or MODE switch to change the distance.
 - Each time you press the SELECT switch, the distance value increases by 500 miles (1,000 km).
 - Each time you press the MODE switch, the distance value decreases by 500 miles (1,000 km).
 - Pressing and holding the SELECT or MODE switch increases or decreases the distance value by 2,500 miles (5,000 km), respectively.
 - If the replacement interval is controlled by the period of time (not by the distance), leave the distance space blank ("---- mi").
5. Press the SET/RES switch ③ to select the interval period setting screen ⑦ (with "month" indicated). The numerals indicating the period of time blink once this screen is selected.
6. Press the SELECT switch or MODE switch to change the value of the period.
 - Each time you press the SELECT switch, the period increases by 1 month.
 - Each time you press the MODE switch, the period decreases by 1 month.
 - Pressing and holding the SELECT or MODE switch increases or decreases the period by 2 months, respectively.
 - If the replacement interval is controlled by the distance (not by the period of time), leave the period space blank ("-- month").
7. Press the SET/RES switch to return to the maintenance information mode ⑤.
8. In the maintenance information mode ⑤, press and hold the SET/RES switch until "0 mile" and "0 months" are indicated to reset the maintenance information.

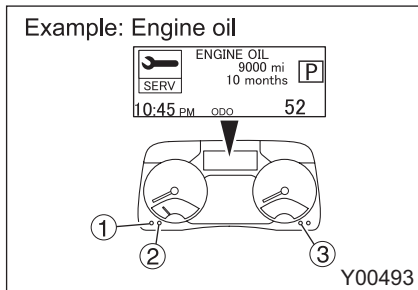
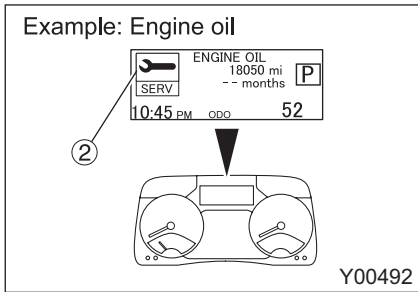
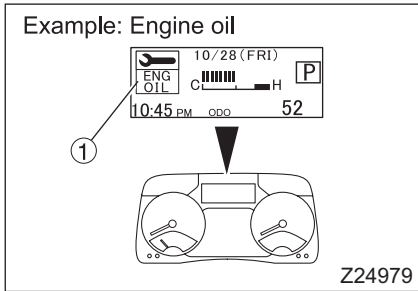

- **Maintenance alert indication**
- For each item for which you have set the replacement interval, an alert ① is indicated at 600 miles (1,000 km) or 1 month before the set distance or period of time is reached. If this condition is met for an item, an alert will be indicated for the item every time the starter switch is turned to "ON". The alert indication goes out as soon as the parking brake is released. If there are multiple alerts to indicate, they are indicated one after another, each being indicated for 3 seconds.

- If a periodic replacement item is used continuously even after the set distance or period is reached, the maintenance information symbol will turn to amber ②.

- **Resetting of maintenance information**

After replacing a periodic replacement item such as the oil, filter element, or engine coolant, reset the maintenance information for the item as follows:

1. Press the MODE switch ① to select the maintenance information mode.
2. Press the SELECT switch ② to select the item for which the maintenance information is to be reset.
3. Press and hold (1 second or more) the SET/RES switch ③ to reset the maintenance information.

NOTE:

Do the same procedure after replacing any periodic replacement item.

Example: DISP indications

<Light switch in "OFF" position>

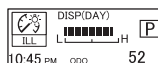

<Light switch in ☰ or ☷ position>

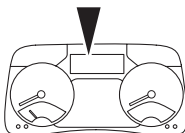
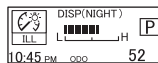

Z24982

3.6 Illumination intensity (brightness adjustment)

- **Selection and adjustment of illumination intensity**
- Both the illumination intensity screen and the adjustment screen provide different displays between the time when the light switch is in the "OFF" position and the time when the switch is in the ☰ or ☷ position as follows:
 - When the light switch is in the "OFF" position, the multi-information display indicates "DISP (DAY)" or "GAUGE (DAY)". In this state, the brightness of the displays or gauges under no illumination condition (daytime) is adjustable.
 - When the light switch is in the ☰ or ☷ position, the multi-information display indicates "DISP (NIGHT)" or "GAUGE (NIGHT)". In this state, the brightness of displays or gauges when illuminated (nighttime) can be adjusted.
- The brightness of the following display and gauges can be adjusted as follows.
 - When "DISP (DAY)" or "DISP (NIGHT)" is displayed:
 - Multi-information display
 - When "GAUGE (DAY)" or "GAUGE (NIGHT)" is displayed:
 - DEF level indicator
 - When "GAUGE (NIGHT)" is displayed:
 - Illumination of the air conditioner control panel and the scales of the speedometer, tachometer, and fuel gauge (when the light switch is in the ☰ or ☷ position)

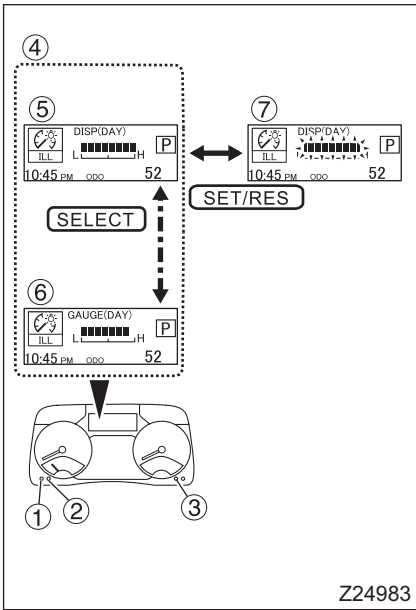

1. Press the MODE switch ① to select the illumination intensity mode ④.
2. Press the SELECT switch ②. Each time you press the switch, the display toggles between “DISP (DAY)” ⑤ and “GAUGE (DAY)” ⑥. When the light switch is in the ☉ or ☾ position, the display toggles between “DISP (NIGHT)” and “GAUGE (NIGHT)”.
3. With the item to be adjusted displayed on the screen, press the SET/RES switch ③ to advance to the adjustment screen ⑦.
4. Adjust the brightness using the MODE switch or SELECT switch.
 - Press the MODE switch to reduce the brightness.
 - Press the SELECT switch to increase the brightness.
5. Return to the illumination intensity display by pressing the SET/RES switch.

WARNING/INDICATOR TELLTALE

The warning/indicator telltale function provides warning and indicator notifications on the multi-information display in the following situations:

- When a problem occurs with a vehicle system
- When a system is activated
- When the distance/period remaining before the replacement time becomes short

1 Telltale indications

1.1 Indication colors

Warnings or indicators are displayed in any of the following colors according to their categories:

- Red
- Amber
- Green
- Black

For the actual colors of the warnings and indicators, please refer to the Quick Reference Guide.

1.2 If there are multiple warnings

If there are multiple warnings to display, all of these warnings are displayed sequentially, each being displayed for 3 seconds.

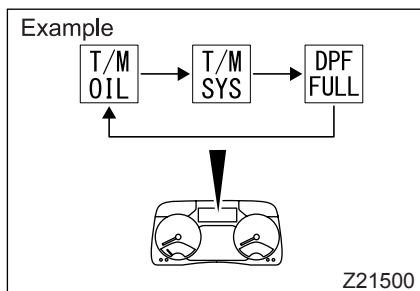

2 Warning and indicator categories













WARNING

Red warnings require you to immediately stop the vehicle at a safe place and take necessary actions. Continuing to drive without taking necessary actions could lead to a serious accident.

CAUTION

Amber warnings alert you to a malfunction or degraded functionality of components. You should continue to drive carefully and then take necessary actions as soon as possible.

2.1 Red, amber and green indications













Indication	Warning/indicator	Condition for lighting/flashing	Ref. page
 (red)	Engine system warning	Engine power is being automatically restricted.	6-24
 (amber)	Engine system warning	Engine must be inspected.	6-24
 (red)	Transmission oil temperature warning	Clutch control fluid or the clutch temperature is too high. *1	6-24
 (red)	Transmission control warning	DUONIC® system is faulty.	6-25
 (amber)	Transmission control warning	DUONIC® system is faulty (but automatic or manual gear shifting is possible).	6-25
 (red)	Cab tilt warning	Cab tilt lock is not completely engaged. (A buzzer will sound at a vehicle speed of 5 km/h (3 mph) or higher.)	12-11
 (red)	SAM warning	Failure has occurred in electric control system of Signal detect and Actuation Module (SAM).	6-25
 (amber)	SAM warning	Failure has occurred in electric control system of SAM (a failure that requires inspection of exterior lamps).	6-25
 (amber)	Overloaded DPF warning	DPF is full.	5-53
 (amber)	Meter cluster warning	Electrical system of meter cluster is faulty.	6-26
 (amber)	Engine oil warning	<ul style="list-style-type: none"> • If the warning appears when the starter switch is moved from "ACC" to "ON", the engine oil level is low. • Engine oil level has decreased or oil quality has decreased if the warning appears when engine is running. 	6-26
 (green)	Engine oil and PCV filter warning	The PCV filter regeneration (or the PCV filter replacement) or the engine oil replacement must be performed.*2	6-27, 12-22
 (amber)	Fuel filter warning	Water in fuel filter has increased.	12-56

*1: The following actions will cause excessive slipping of the clutch and heat generation:

- Holding the stopped vehicle on an up slope using only the accelerator pedal and moving the vehicle very slowly for a long time.
- Depressing the accelerator pedal when the vehicle is stopped with the gearshift lever in the "D" or "R" position and the brake pedal depressed or the parking brake applied.
- Moving the vehicle very slowly repeatedly to drive over a high step or curb.

*2: If the engine oil has not been replaced in a long period of time.

2.2 Black indications

Indication	Warning/indicator	Condition for lighting/flashing	Ref. page
	<Vehicles with transmission PTO> PTO indicator	Appears when transmission PTO is engaged.	5-47
	<Vehicles with transmission PTO> PTO engagement preparation indicator	Appears when transmission PTO is preparing to engage.	5-47
	Engine oil replacement alert indicator	Distance or period remaining before scheduled engine oil replacement time is less than 1,000 km (600 miles) or 1 month	6-15
	Engine oil filter replacement alert indicator	Distance or period remaining before scheduled engine oil filter replacement time is less than 1,000 km (600 miles) or 1 month	6-15
	Fuel filter replacement alert indicator	Distance or period remaining before scheduled fuel filter replacement time is less than 1,000 km (600 miles) or 1 month	6-15
	Brake fluid replacement alert indicator	Distance or period remaining before scheduled brake fluid replacement time is less than 1,000 km (600 miles) or 1 month	6-15
	Air cleaner replacement alert indicator	Distance or period remaining before scheduled air cleaner replacement time is less than 1,000 km (600 miles) or 1 month	6-15
	Transmission oil replacement alert indicator	Distance or period remaining before scheduled clutch control fluid and transmission oil replacement time is less than 1,000 km (600 miles) or 1 month	6-15
	Wheel hub bearing grease replacement alert indicator	Distance or time remaining before scheduled wheel hub bearing grease replacement is less than 1,000 km (600 miles) or 1 month	6-15
	Differential gear oil replacement alert indicator	Distance or period remaining before scheduled differential gear oil replacement time is less than 1,000 km (600 miles) or 1 month	6-15
	Power steering oil replacement alert indicator	Distance or period remaining before scheduled power steering oil replacement time is less than 1,000 km (600 miles) or 1 month	6-15
	Engine coolant replacement alert indicator	Distance or period remaining before scheduled engine coolant replacement time is less than 1,000 km (600 miles) or 1 month	6-15



Z21711

2.3 Engine system warning

- **Red warning**

If this warning appears, contact an authorized dealer immediately to have the vehicle inspected.

- **Amber warning**

If this warning appears, contact an authorized dealer as soon as possible to have the vehicle inspected.



Z21712

2.4 Transmission oil temperature warning

- **The warning appears and the buzzer sounds three times**

This warning appears when the clutch control fluid temperature is too high.

If this warning appears while driving, stop the vehicle in a safe place and do the following:

1. Firmly apply the parking brake and move the gearshift lever to "P".
2. Run the engine at a speed slightly higher than the idling speed. If the warning disappears, you may continue driving. If the warning remains displayed, contact your nearest authorized dealer.

- **The warning appears and the buzzer continues sounding**

The clutch temperature is abnormally high because the clutch would slip.

If this warning appears while driving, do the following:

1. Select a lower gear than usual in the manual shift mode and start the engine.
2. If the warning remains shown, stop the vehicle in a safe place and be sure to fully apply the parking brake.
3. Place the gearshift lever in the "P" position. Depress the accelerator pedal to run the engine at a speed slightly higher than the idling speed in order to cool down the engine.
4. If the warning disappears and the buzzer stops, you may continue to drive. If the warning remains on, contact an authorized dealer.



CAUTION

Do not stop the engine without letting the transmission cool down, otherwise the transmission may seize up. Stop the engine only after the  warning has disappeared.



T / M
SYS

Z21713

2.5 Transmission control warning

• Red warning

The red transmission control warning appears when the DUONIC[®] system is faulty.

If this warning appears while driving, stop the vehicle in a safe place and do the following:

1. Firmly apply the parking brake and move the gearshift lever to "P".
2. Turn the starter switch to "ACC" or "LOCK".
3. Turn the starter switch to "ON".
4. If the warning remains shown, avoid continuing to drive and contact your nearest authorized dealer.

• Amber warning

The amber transmission control warning appears when the DUONIC[®] system is faulty (but automatic or manual gear shifting is possible).

- If driving in the automatic shift mode is possible, you may continue to drive but must have the vehicle inspected by an authorized dealer as soon as possible.
- If no automatic gearshift takes place when driving in the automatic gearshift mode, stop the vehicle in a safe place and do the following:
 1. Firmly apply the parking brake and move the gearshift lever to "P".
 2. Turn the starter switch to "ACC" or "LOCK".
 3. Turn the starter switch to "ON".
 4. If the warning remains shown but driving in the manual gearshift mode is possible, take the vehicle to an authorized dealer for inspection as soon as possible.
 5. If the warning remains shown and gear shifting is impossible in the manual gearshift mode, contact your nearest authorized dealer.



SAM

Z21714

2.6 SAM warning

NOTE:

SAM, which stands for Signal Detection and Actuation Module, is a module that integrates the control and power distribution functions for the electric equipment of the cab and truck body.

• Red warning

The red SAM warning appears when a failure occurs in the electric control system of the SAM.

If this warning appears while driving, stop the vehicle in a safe place and do the following:

1. Firmly apply the parking brake and move the gearshift lever to "P".
2. Turn the starter switch to "LOCK".

3. Turn the starter switch back to "ON". If the warning disappears, there are no problems. If the warning remains shown, contact your nearest authorized dealer immediately.

- **Amber warning**

The amber SAM warning appears when a failure (of a type that requires inspection of exterior lamps) occurs in the electric control system of the SAM.

If this warning appears while driving, stop the vehicle in a safe place and perform the following:

1. Firmly apply the parking brake and move the gearshift lever to "P".
2. Turn the starter switch to "LOCK".
3. Check the exterior lamps for abnormalities. Replace a malfunctioning lamp if any.
 - ⇒  P. 13-18
4. Turn the starter switch back to "ON".
5. Switch on the replaced lamp. If the warning disappears, there is no remaining problem with the SAM.
6. If the warning remains shown, contact an authorized dealer as soon as possible.



2.7 Meter cluster warning

This warning appears when the electrical system of the meter cluster is faulty.

If this warning appears while driving, stop the vehicle in a safe place and perform the following:

1. Firmly apply the parking brake and move the gearshift lever to "P".
2. Turn the starter switch to "LOCK".
3. Turn the starter switch back to "ON". If the warning disappears, there are no problems.
4. If the warning remains shown, do not continue to drive but contact your nearest authorized dealer immediately.



2.8 Engine oil warning (Amber)

The  warning indicates that the engine oil level has decreased, or that the oil quality has decreased due to fuel mixing with the engine oil.

- Stop the vehicle in a flat area and check the engine oil level if this warning appears. In this case, the engine oil level can be checked automatically from the driver's seat.
 - ⇒  P. 12-26

The vehicle can continue to be driven if the warning disappears after checking the oil level.



- Replace the engine oil if the warning remains shown.
- If even more fuel is mixed with engine oil, this warning and the  (amber) warning are alternately displayed. If this happens, replace the engine oil immediately.

ENG OIL

Z21719

2.9 Engine oil and PCV filter warning (Green)

This warning appears when the PCV (Positive Crankcase Ventilation) filter is likely to clog because the vehicle was frequently left idling for long periods of time, or if the engine oil has not been replaced in a long period of time.

- Regenerate (or replace) the PCV filter when  (Green) warning appears.
- If this warning does not extinguish even after the PCV filter is regenerated, the engine oil must be replaced. Replace the engine oil and be sure to reset the engine control unit. ⇨  P. 12-29

NOTE:

- *The warning does not extinguish by replacing the PCV filter only. Regenerate the PCV filter, or replace the engine oil and reset the engine control unit.*
- *Have the PCV filter replaced at your nearest authorized dealer.*

PCV filter regeneration procedure

To regenerate the PCV filter, use the following procedure.

1. Stop the vehicle in a safe place, firmly apply the parking brake and move the gearshift lever to "P".
2. Press the accelerator pedal fully so that the engine speed is 4,000 rpm, and wait for 2 minutes.
3. Release the accelerator pedal after 2 minutes. Check that the warning is no longer displayed when the engine speed drops back to idle speed.

NOTE:

If this warning does not extinguish even after the above operation, the engine oil must be replaced. Replace the engine oil, and be sure to reset the engine control unit. ⇨  P. 12-29

WARNING/INDICATOR LAMPS

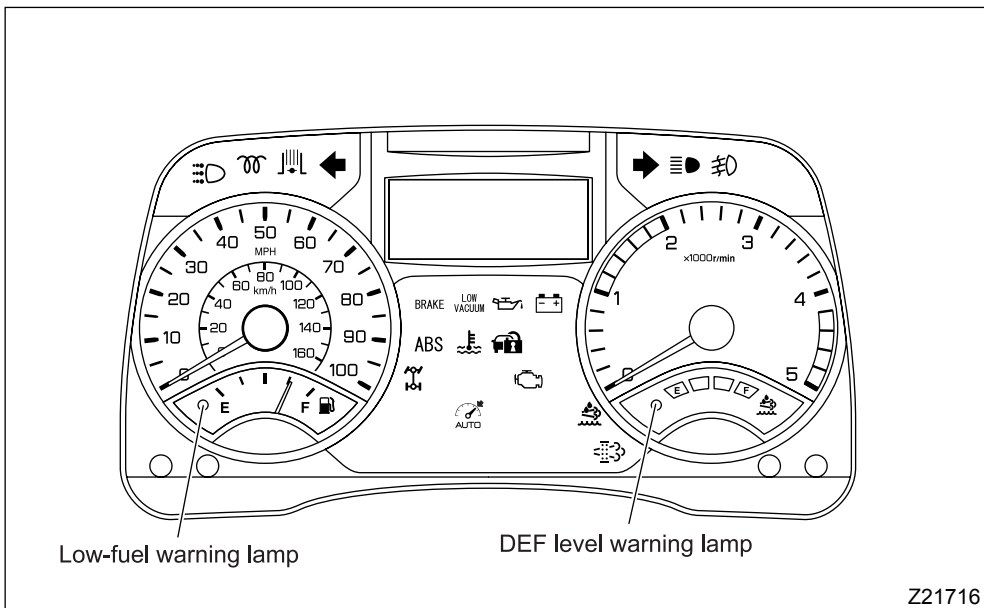











The illustration shows the standard arrangement of the warning and indicator lamps. Some lamps shown here, however, may not be installed on your vehicle. For the actual colors of the warning lamp, please refer to the Quick Reference Guide. Illumination of certain warning lamps is accompanied by sounding of a buzzer.



CAUTION

The red warning lamps, if illuminated, warns you of vehicle component failures and possible danger of accident. Never drive the vehicle while a red warning lamp is illuminated. If any of them light up, stop the vehicle as soon as it is safe to do so and perform checks for locating the cause. If necessary, have your vehicle repaired by an authorized dealer.

NOTE:

The red warning lamps may also illuminate if the engine is started when the battery's performance has decreased. In this event, either charge the battery or replace the battery with a new one.







Lamp symbol	Warning/indicator lamp	If illuminates or flashes	Ref. page
•	Fuel level warning lamp	Level of fuel in fuel tank excessively low	1-7 6-4
↔	Turn signal indicator lamp	Turn signal or hazard warning lamps flashing	5-17 5-44
	Headlamp high beam indicator lamp	Headlamp high beams illuminated	5-17
	Exhaust brake indicator lamp	Exhaust brake activated	5-18
	Fog lamp indicator lamp	Fog lamps illuminated	5-45
	Engine preheat indicator lamp	Engine being preheated	5-7
LOW VACUUM	Vacuum pressure warning lamp	Excessively low vacuum in vacuum tank	6-32
BRAKE	Brake warning lamp	Brake fluid at an excessively low level (*) or parking brake activated	6-33
	Charge warning lamp	Problem in battery charging system	6-33
	Engine oil pressure warning lamp	Excessively low engine oil pressure (**)	6-34
	Engine control warning lamp	<ul style="list-style-type: none"> • Fault in engine control system • Fault in BlueTec® exhaust gas aftertreatment system 	6-34
	4WD indicator lamp <FG>	Four-wheel drive (4WD) mode selected	8-3
ABS	ABS warning lamp	Fault in antilock braking system (ABS)	6-35
	Daytime running light indicator lamp	Headlamps (low-beam) illuminated by daytime running light system	5-17
	Engine overheating warning lamp	Coolant temperature abnormally high	6-35
	Cruise control indicator lamp <Vehicles with cruise control>	Cruise control activated	5-38

Lamp symbol	Warning/indicator lamp	If illuminates or flashes		Ref. page
	DPF indicator lamp	Slow flashing (0.5-second interval; amber)	DPF contains a lot of PM	5-52
		Fast flashing (0.25-second interval; amber)		
		Illumination (amber)	Parked DPF regeneration in progress	
		Illumination (green)	Automatic DPF regeneration in progress	
	DEF warning lamp	<ul style="list-style-type: none"> Quantity of DEF in DEF tank has fallen too low Abnormality detected in BlueTec® exhaust gas aftertreatment system 		5-61
●	DEF level warning lamp	Quantity of DEF in DEF tank has fallen too low		5-61
	Engine immobilizer warning lamp <Vehicles with engine immobilizer>	<ul style="list-style-type: none"> Disturbed communication with engine immobilizer starter key Fault in engine immobilizer 		6-36

NOTE:

- Illumination of any warning lamp marked (*) is accompanied by sounding of a buzzer.
- Illumination of any warning lamp marked (**) may be accompanied by sounding of a buzzer under certain conditions.

The warning lamps shown below illuminate when the starter switch is turned from the “ACC” position to the “ON” position but almost immediately extinguish.

Lamp symbol	Warning lamp	Operation
BRAKE	Brake warning lamp	Extinguishes when the parking brake is released. However, when the engine is not in operation, this lamp does not extinguish even if the parking brake is released.
LOW VACUUM	Vacuum pressure warning lamp	Extinguishes when engine is started.
	Charge warning lamp	Extinguishes when engine is started.
	Engine oil pressure warning lamp	Extinguishes when engine is started.
	Engine control warning lamp	Extinguishes when engine is started.
ABS	ABS warning lamp	Extinguishes a few seconds after the starter switch is turned to the “ON” position.
	Engine immobilizer warning lamp	Extinguishes a few seconds after the starter switch is turned to the “ON” position.
	DEF warning lamp	Extinguishes a few seconds after the starter switch is turned to the “ON” position.
●	DEF level warning lamp	Extinguishes a few seconds after the starter switch is turned to the “ON” position.
	DEF level indicator lamp	Extinguishes a few seconds after the starter switch is turned to the “ON” position.

LOW VACUUM

Z10909

1 Vacuum pressure warning lamp

WARNING

Braking is dangerously sluggish when the vacuum warning lamp is illuminated. For safety, never drive with the vehicle in this condition.

This lamp illuminates when the starter switch is turned to the "ON" position. As long as the warning lamp extinguishes when the engine is started, the vehicle may be driven. If illuminated while the engine is running, this warning lamp signals that the vacuum level in the brake vacuum tank has dropped below the safe limit.

Since braking becomes sluggish under this condition, depress the brake pedal with full force to slow down the vehicle, then pull off the road as soon as it is safe to do so, and firmly apply the parking brake.

Perform the following checks:

1. Let the engine run at intermediate RPM until the warning lamp extinguishes.
2. Check the pipes, hoses and its connections for vacuum leaks.
3. If the warning lamp does not extinguishes or illuminated again soon after it has extinguished, the vacuum system is malfunctioning and must be repaired. Call an authorized dealer.

BRAKE

Z10908

2 Brake warning lamp

WARNING

If the brake warning lamp illuminates due to an excessively low level of brake fluid, the brakes will not be fully effective and driving the vehicle be dangerous. Do not drive the vehicle in this condition.

This warning lamp illuminates when the parking brake lever is pulled or when the brake fluid level drops below the safe limit. If the brake fluid level is too low, a buzzer also sounds. The buzzer stops when the parking brake is applied. Should the warning lamp remain illuminated even after the parking brake lever has been released or illuminate during driving, pull off the road as soon as it is safe to do so, and perform the checks below.

With the starter switch in the "ON" position and the engine not running, the warning lamp will stay on even if the parking brake lever is released. The warning lamp will extinguish if the engine is started.

1. Check the brake fluid level.

Replenish the reservoir if the level is too low.

⇒  P. 12-37

2. Pump the brake pedal several times to make sure that the fluid level does not drop.
3. If the fluid level drops, it indicates fluid leakage. Call an authorized dealer.

3 Charge warning lamp

The charge warning lamp illuminates when the starter switch is turned to the "ON" position and extinguishes as soon as the alternator starts charging the battery after the engine has turned over.

The warning lamp also illuminates if a problem occurs in the battery charging system while the engine is running. If this occurs, pull off the road as soon as it is safe to do so, and perform the following checks.

1. Check the V-belt for breakage and excessive deflection.

⇒  P. 12-66

In addition, check the pulley of each auxiliary equipment for damage.

2. Check for a blown high-current fuse in the battery charging circuit. If blown, replace with a new one.

⇒  P. 13-16

3. If both the above checks have turned out normal, the problem is probably in the battery charging system. Call an authorized dealer.

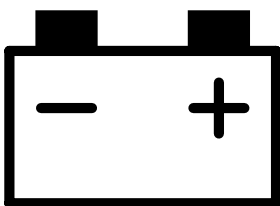

Z10484

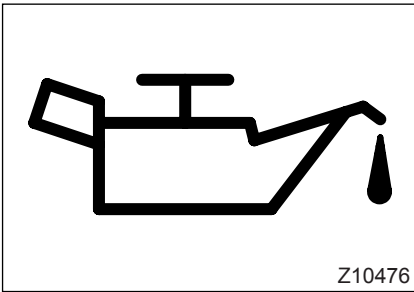

4 Engine oil pressure warning lamp

The engine oil pressure/level warning lamp illuminates when the starter switch is turned to the “ON” position and extinguishes as soon as the engine is turned over. If the warning lamp illuminates while the engine is running, the cause may be an excessively low engine oil pressure. Pull off the road as soon as it is safe to do so, and perform the following checks.

1. Check the engine oil level. Add if insufficient.
⇒ P. 12-22
2. Check various parts of the engine for any sign of oil leaks.
3. If the oil level is normal and there are no oil leaks, the problem is in the lubrication system. Call an authorized dealer.

CAUTION

- Do not drive if the engine oil pressure warning lamp is on. The engine could seize up. If the lamp turns on while driving, stop in a safe location as soon as possible.
- When the engine oil pressure warning lamp illuminates, the warning appears (red) and the buzzer sounds, the engine speed is limited to 1500 rpm. The buzzer will continue to sound until the engine is stopped.
- Continuing to drive will further limit driving, and the engine will stop. If the conditions above occur, inspect and refill the engine oil as soon as possible.

5 Engine control warning lamp

This warning lamp illuminates when the starter key is turned to “ON”. This warning lamp should extinguish when the engine starts.

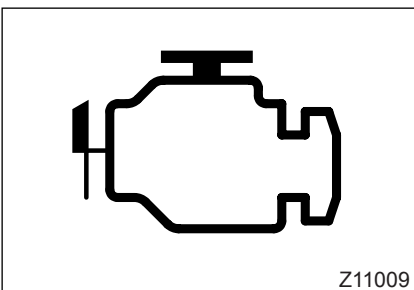

If this warning lamp illuminates at any other time, there is a fault in the exhaust gas aftertreatment. Have the vehicle inspected by an authorized dealer.



Z10986

6 ABS warning lamp

This warning lamp illuminates when the starter key is turned to "ON". This warning lamp should extinguish a few seconds later. If the warning lamp illuminates again, this indicates there is a malfunction in the antilock braking system (ABS). Should this warning lamp illuminate during driving, stop the vehicle in a safe place and perform the following inspection.

1. Turn the starter key to the "OFF" position and then to the "ON" position again.
2. Determine the system condition as follows:
 - The system is normal if the warning lamp extinguishes in a few seconds after the starter key is turned to "ON". The system is also normal if the warning lamp does not extinguish after a few seconds but then extinguishes as soon as the vehicle is started.
 - The system is faulty if the warning lamp remains illuminated for a few seconds after the vehicle is started or it extinguishes but illuminates again.
3. If the system is found to be faulty, have the system repaired by an authorized dealer as soon as possible.

NOTE:

Even with the ABS faulty and the warning lamp remains illuminated, the normal brake system is still functioning satisfactorily. Only the ABS function is lost. Drive with great care on slippery surfaces with the vehicle in this condition.

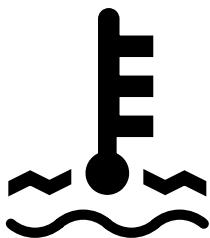

Z10486

7 Engine overheating warning lamp

- This warning lamp illuminates if the engine coolant temperature becomes abnormally high. When this warning lamp illuminates, the engine power is limited, but the vehicle can still be driven.
- If a buzzer sounds while this warning lamp is illuminated and the  warning (red) is displayed on the multi-information display, the engine has overheated. Stop the vehicle in a safe place and take necessary actions.

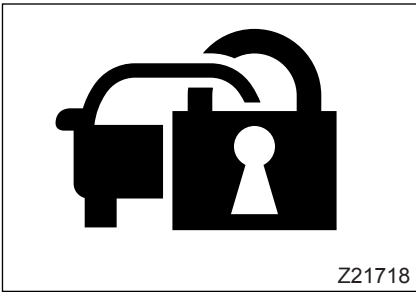

⇒  P. 13-8





8 Engine immobilizer warning lamp

This warning lamp should normally illuminate when the starter switch is turned to “ON” and then extinguish a few seconds later. If the warning lamp fails to extinguish, communication with the engine immobilizer starter key may be obstructed or the engine immobilizer itself may be faulty. In this case, perform the following inspection.

8.1 When the engine cannot be started

- Check whether a metal piece or another key is in contact with the engine immobilizer starter key. If you find any metal piece or another key touching the starter key, separate them, turn the starter switch back to “ACC” or “LOCK”, and then try starting the engine.
- The engine immobilizer is normal if the engine can be started and the  warning lamp extinguishes.
- If the engine cannot be started and the  warning lamp remains illuminated, try starting the engine using another registered starter key. If you still cannot start the engine, the engine immobilizer is probably faulty; contact an authorized dealer.

8.2 When the engine can be started

- Turn the starter switch back to “ACC” or “LOCK” and then restart the engine.
- If the  warning lamp extinguishes, the engine immobilizer is normal.
- If the engine cannot be started and the  warning lamp remains illuminated, the engine immobilizer is probably faulty. Contact an authorized dealer as soon as possible.

7. STARTING AND OPERATING YOUR VEHICLE

PRECAUTIONS WHILE SHIFTING THE VEHICLE INTO GEAR	7-2
DRIVING PRECAUTIONS	7-3
TIPS FOR IMPROVING FUEL ECONOMY	7-7
BRAKING	7-8
ANTILOCK BRAKING SYSTEM (ABS)	7-9
ON UPHILL AND DOWNHILL ROADS	7-12
ON ROUGH ROADS AND IN BAD WEATHER	7-14
PARKING	7-16
VEHICLES WITH LIMITED SLIP DIFFERENTIAL *	7-18
LOADING CARGO	7-20

*: If equipped

**PRECAUTIONS WHILE SHIFTING
THE VEHICLE INTO GEAR**** WARNING**

- Do not carry containers of fuel or spray cans in the cabin. Carrying fuel in the cabin is extremely dangerous because an increase in the cabin temperature could cause fuel vapor to catch fire or cause the container to rupture.
- When starting out, do not operate the gearshift lever while holding down the accelerator pedal. Doing so could cause the vehicle to start out suddenly and create the risk of serious accident. When starting out, keep the brake pedal depressed while operating the gearshift lever.
- Do not race the engine while stopped. Leaving the gearshift lever in any position other than "P" or "N" could cause sudden acceleration and create the risk of serious accident.

 CAUTION

- When starting out, keep the brake pedal fully depressed while operating the gearshift lever and release it after moving the gearshift lever. Unless you keep the brake pedal fully depressed when placing the gearshift lever in the "R" or "D" position, the resulting creep could cause an accident.
- Keep the brake pedal fully depressed while the display on the gear position indicator is flashing. This is especially important when starting on an uphill road. As the gear is not yet engaged and thus the creep effect is not available while the display is flashing, the vehicle may move backward if the brake pedal is released, which could cause an accident.

- Do not attach anything to the windshield.
- Do not attach accessories, stickers or other objects to windows. Doing so could not only interfere with driving, but the suction cap could act like a lens and cause a fire.
- You should be familiar with how to use the DUONIC® system controls before starting your vehicle. ⇒  P. 5-21
- Check the immediate area around the vehicle, using mirrors as necessary: there should be no persons or obstacles under, in front of, on either side, or behind the vehicle. Be particularly careful when backing up.
If you wish to back up but cannot confirm safety behind the vehicle using the mirrors, get out of the vehicle and perform the check.
- Check that none of the red warning lamps are illuminated and no warnings are indicated on the multi-information display. The BRAKE warning lamp will extinguish when the parking brake is released.
- Fully release the parking brake.
- For safety, always move the gearshift lever into a position from the “P” position while keeping the brake pedal depressed.

DRIVING PRECAUTIONS

Observe the following precautions while driving. Should you notice anything unusual about the vehicle, immediately stop the vehicle and inspect the relevant sections to find the cause of the trouble. If you are unable to identify the cause of the trouble or unable to do the repairs yourself, call your nearest authorized dealer.

- Do not stop the engine while the vehicle is moving.

 **WARNING**

- **Never place the starter switch in any position other than the “ON” position while operating the vehicle.**
If you turn the starter switch to the “ACC” position, the engine will stop. This is dangerous.
If the engine stops during driving:
 - **The braking force is severely reduced.**
 - **The power steering system becomes inoperative, rendering steering dangerously sluggish.**
 - **The fuel injection system can malfunction.**
 - **The electrical circuits of the warning lamps, meters, etc. become inoperative, causing electric components to malfunction.**
 - **Never use a slope to move the vehicle with the engine stopped. This practice is very dangerous and could lead to an accident because when the engine is stopped, the steering wheel becomes difficult to operate and the brakes become much less effective.**
 - **Never remove the starter key while driving. Removing the starter key causes the steering wheel to lock, making it impossible to steer the vehicle.**
-
- Do not exceed the maximum legally permissible speed. Overspeeding, overloading or incorrectly loading the vehicle increases the danger of the vehicle losing its stability or deteriorate braking performance.
 - Should the engine stall while the vehicle is in motion, do not panic. Depress the brake pedal to slow the vehicle, and stop in a safe place.
 - If a red warning lamp illuminates, or if any warning appears on the multi-information display, the buzzer sounds, or the vehicle behaves abnormally, stop the vehicle in the nearest safe place and investigate the cause. ⇨  P. 6-28
If you cannot identify the cause or cannot rectify the problem, contact an authorized dealer.
 - Avoid making sharp turns and braking hard except in emergencies. Doing so during high-speed driving could cause the vehicle to tip over.
 - Be sure to press the brake pedal with the right foot. Operating the brake pedal with the unac-

customed left foot may delay your reaction in emergencies and cause unforeseen accidents.

- If you notice a strange noise, vibration, or smell, or if steering or braking feels unusual, pull the vehicle off the road as soon as it is safe to do so and check for the source of the trouble. If you cannot determine the cause of the problem and/or cannot rectify it, contact the nearest authorized dealer.
- When driving on narrow streets or when making a turn, keep in mind that the tracking of the front and rear inner wheels is different, and also make sure of rearward safety using the rearview mirrors.
- Remember that the mirrors protrude from the vehicle body. Be careful not to hit pedestrians and obstructions with the mirrors when driving on narrow roads.

Looking at the mirrors while driving causes your line of vision to move significantly. Be sure to keep paying attention to safety ahead of the vehicle.

- Do not keep the steering wheel turned fully to either side for more than 10 seconds. Doing so could cause the power steering system to malfunction.
- Do not try to forcefully turn the steering wheel when the front wheels are stuck against a curbstone or other object. Doing so could cause the steering gearbox to fail.
- Continuous high-speed driving burdens the engine and other vehicle parts. Allow yourself enough time that you do not need to push the vehicle too hard.
- Perform your pre-operation checks with particular care when you expect to drive at high speeds. When continuously driving at high speeds, your sense of speed may become dull. Pay constant attention to your speed, and maintain an adequate distance from the preceding vehicle.
- If a tire bursts or gets punctured while you are driving at high speed, do not panic. Keep a firm grip on the steering wheel and gradually reduce your speed. Stop the vehicle in the nearest safe place. Do not brake sharply. Braking sharply would be dangerous because the steering wheel would be pulled to one side with great force.
- Do not drive your vehicle if a tire has been punctured. Failure to observe this precaution will expose the wheel bolts to excessive force causing damage to the bolts or the wheel.

- When driving at high speeds in the rain, it is possible that the tires will ride on a film of water and lose contact with the road surface. This is known as “hydroplaning”. If this should happen, you will lose control of both steering and braking. Therefore, be sure to maintain moderate speeds on rainy days.

Hydroplaning can easily occur if tire tread is worn to the point where the tread pattern is very shallow.

- Do not use a mobile telephone while driving. If you wish to use a mobile telephone, first stop the vehicle in a safe place. Using a mobile telephone while driving could distract your attention from the vehicle and from the road ahead, resulting in an accident.
- Operate the radio and other items of equipment in the cab when the vehicle is stationary. It is dangerous to operate this type of equipment or use a mobile telephone (other than a hands-free type) while driving.
- Do not allow a child to touch the driver’s controls and other equipment. A child’s interference could cause a fault or accident.
- For normal driving, select the “D” position.

⇒  P. 5-21

- Do not move the gearshift lever to the “N” or “P” position while the vehicle is in motion. If the gearshift lever were moved to the “N” or “P” position with the vehicle in motion, abnormal sounds and vibration would occur. Also, transmission components could be broken, resulting in a serious accident. Always stop the vehicle before placing the gearshift lever in the “N” or “P” position.
- If the system judges that a manual upshift or downshift would put the engine speed out of the normal rpm range, the gearshift does not take place.

Adjust the vehicle speed with the accelerator or brakes before making an upshift or downshift with the gearshift lever.

- If you stop the vehicle momentarily, for example, at a red light, be sure to keep the brake pedal depressed. Without the brakes applied, the vehicle will move, although only very slowly, even if the accelerator pedal is not depressed. If you must wait for longer than expected, select the “N” or “P” position and pull the parking brake lever.

- If you stop temporarily when driving uphill, depress the brake pedal and pull the parking brake lever. Do not attempt to stop the vehicle from rolling backwards with the accelerator pedal.
- Idling for long periods of time can adversely affect fuel economy and cause degradation of the engine oil. Instead of leaving the engine to idle unnecessarily, turn the engine off whenever possible.

TIPS FOR IMPROVING FUEL ECONOMY

Observe the following precautions to achieve maximum fuel economy and to extend tire life.

- A time of 1 to 2 minutes will be sufficient for warming up the engine.
- Avoid racing the engine as doing so not only wastes fuel but also harms the engine.
- Avoid aggressive vehicle launch from a stop, aggressive acceleration and aggressive braking.
- When accelerating, do not allow the engine to wind out before changing gears; instead, change gears before engine speed reaches a high RPM.
- Fuel consumption can be minimized by keeping the tachometer needle in the 1,000 to 2,000 rpm range.
- Fuel consumption can be further minimized by setting the economy mode switch to ON.
- Always shut off the engine when the vehicle is parked. Never park the vehicle or leave it with the engine running, even for a short time.
- Operate the vehicle at a moderate and constant speeds. Aggressive acceleration and deceleration causes fuel waste.
- Do not keep the exhaust brake switch* in the activated position at all times. Doing so repeatedly decelerates and accelerates the vehicle speed due to the frequent operation of the exhaust brake, which reduces fuel economy. Move the exhaust brake switch between the activated and non-activated positions as necessary for road and traffic conditions.
- Always keep the air pressure in tires correctly adjusted. Periodically rotate the tires.
- Use the specified types of tires and disc wheels only. Use of the wrong size tires can interfere with correct DUONIC® (transmission) shift timing and result in poor fuel economy.
- Try to load cargo in a way that minimizes wind resistance. ⇨  P. 7-20
- Be sure to perform the pre-operational checks and periodic inspections.

*: If equipped

BRAKING

When driving downhill, use engine braking as well as exhaust braking* in combination with the foot brake. →  P. 7-12

**WARNING**

- When warning lamps ^{LOW VACUUM} and/or ^{BRAKE} illuminate, immediately stop the vehicle and perform necessary checks. →  P. 6-29
- Avoid sudden braking except in emergency. Sudden application of the brakes generates a large shock, which could cause an accident. Sudden braking will wear down tires and could cause malfunctions in other sections of the vehicle.
- Avoid overusing the service brakes as the resultant overheating could cause undesirable vapor lock and fading, which contribute to poor braking.
- Do not use the exhaust brake on a wet, frozen, snow-covered, or otherwise slippery road surfaces when the vehicle is lightly loaded or not loaded. Using the exhaust brake under these conditions could cause the tires to slip on the road surface, resulting in a skid. The tires are particularly liable to slip when the vehicle is traveling downhill.
- Reduce the vehicle speed before negotiating a curve while braking. If the tires slip due to the road surface being slippery or when the vehicle passes over a step in the road, the ABS may function, causing the exhaust brake to be temporarily released, which may result in a serious accident.

1. Use engine braking and exhaust brake to decelerate sufficiently before applying the brakes.
2. Depressing the brake pedal in two or three stages contributes to stable braking.
Remember that the braking distance varies with vehicle speed, load weight, and road conditions.

*: If equipped

NOTE:

- *Engine braking is a braking effect realized when the accelerator pedal is released during vehicle operation. The lower the transmission gear, the more powerful the engine braking.*
- *“Vapor lock” refers to the condition in which the brake system overheats, causing the brake fluid to boil and form bubbles that weaken hydraulic pressure, resulting in poor braking.*
- *“Fading” refers to the condition in which the brake pads overheat to the point where friction is significantly reduced. This also results in poor braking.*
- *Using the service brake raises the temperature of the brake pads and linings, and could cause the chemicals within the brake pads and linings to vaporize and generate smoke. Brake performance does not drop significantly even if smoke is generated.*

**WARNING**

Never operate the vehicle if the brake system is faulty or brake fluid is leaking. Failure to observe this instruction could lead to a serious accident.

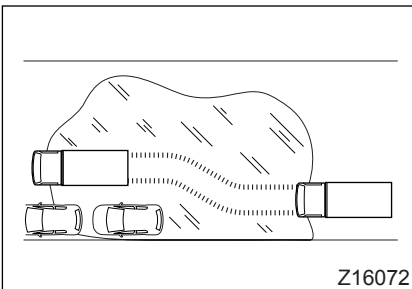
ANTILOCK BRAKING SYSTEM (ABS)

If a vehicle is driven on a slippery road or it is running with no or only light load, the wheels can lock and then skid when the brake pedal is strongly depressed. The ABS is a computer-controlled system that prevents the wheels from locking by controlling the braking force on each wheel.

The ABS is combined with Electronic Brake force Distribution (EBD), which appropriately distributes the braking force according to the weight on each axle and can delay operation of the ABS to the point beyond which all wheels will lock.

! WARNING

- The ABS is not intended to make it possible to drive in a manner exceeding the vehicle's performance limits. It is your responsibility to take sufficient care to assure safety when driving on a slippery road.
- The ABS does not always shorten the braking distance. Do not depend too much on the system, but keep safe following distances.

! CAUTION

- ABS parts, electrical wiring and other parts are installed on the inner side of the tires. Be careful not to spray them with high-pressure water to clean the suspension and other parts, or steam from high pressure cleaners. Doing so will cause damage or malfunctions to equipment.
- If you intend to install radio equipment, please contact an authorized dealer beforehand.

1 Driving tips**NOTE:**

- *If the ABS is malfunctioning and the ABS warning lamp remains illuminated, no ABS functions are available. Even if this condition happens, the brakes work normally. If the warning lamp remains illuminated, have the vehicle repaired by an authorized dealer as soon as possible.*
- *To be able to take prompt actions in any situation involving ABS operation, you should know its operational characteristics, which are as follows:*
 - *On an ordinary road surface, the ABS may work even when you do not apply heavy braking.*
The ABS may work only on the rear wheels at the time of relatively strong braking on a dry road surface if the vehicle is lightly loaded or not loaded. This does not indicate an abnormal condition. If the brake pedal is further depressed after the ABS event has occurred with the rear wheels, the braking force on the front wheels increases, shortening the stopping distance.
 - *The ABS functions even while the wheels are not locking.*

The system performs the necessary control by sensing the vehicle speed and the degree of acceleration, in order to prevent complete lockup of the wheels.

- While the ABS is in operation, it is not necessary to pump the brake pedal (depressing the pedal two or three times), as the system automatically adjusts the braking forces. If you pump the brake pedal, the braking distance will increase as the pedal must be released during pumping.



1.1 Brake pedal operation

Hold the brake pedal depressed as necessary even when the ABS is in operation.

When the ABS is operating, you may feel very slight or slow vibration through the brake pedal. This does not indicate an abnormal condition. Continue depressing the brake pedal.

You may also feel slight vibration of the vehicle body or hear the sound of a motor running. These conditions are caused by normal operation of the system, and are not a fault.

1.2 Braking distance

The braking distance varies with the road surface condition. On a gravel road or a road covered with deep, fresh snow, the braking distance may be longer with ABS-equipped vehicles than with vehicles without ABS.

1.3 Steering wheel operation

In the case of hard braking, you may feel the vehicle pulling slightly to the right or left. If this occurs when the wheels on one side are on ice or another slippery surface and the wheels on the other side are not, you may have to correct the direction with the steering wheel.

1.4 ABS warning lamp

If the ABS warning lamp illuminates while driving, the system is faulty. Pull off the road as soon as it is safe to do so, and perform the checks.

⇒ P. 6-35

Although the ABS function is not available under this condition, the brake system operates normally.

ON UPHILL AND DOWNHILL ROADS

1 Uphill roads

When driving the vehicle using the manual shift mode, downshift early if the vehicle speed begins to drop to minimize the load on the engine.

NOTE:

The vehicle may move backward when starting on an uphill road. Using also the parking brake will help to start successfully in this case.

2 Downhill roads

- If you are going to drive down a steep road or a road with a long downhill grade, test the service brakes and exhaust brake* in advance to make sure that they are functioning properly.
- Place the vehicle in the gear used when driving uphill and use engine braking and exhaust brake to help slow the vehicle. Never drive downhill at high speeds.
- On slippery roads, avoid sudden engine braking since this could cause a skid.



WARNING

- **Never coast downhill with the gearshift lever in the “N” position. Doing so makes both engine braking and exhaust brake* inoperative, which in turn excessively burdens the service brakes. This also causes the brakes to overheat and the brake pads to wear out prematurely. This can also cause damage to the transmission.**
- **Avoid overusing the service brakes as the resultant overheating could cause undesirable vapor lock and fading, both of which contribute to poor braking.**

NOTE:

- *“Vapor lock” refers to the condition in which the brake system overheats, causing the brake fluid to boil and form bubbles that weaken hydraulic pressure, resulting in poor braking.*
- *“Fading” refers to the condition in which the brake pads overheat to the point where friction is significantly reduced. This also results in poor braking.*

*: If equipped

 **WARNING**

Except in an emergency, never apply the parking brake while the vehicle is moving since the vehicle could spin and/or overturn.

- First decelerate the engine sufficiently before downshifting.
Shifting down will be prohibited by a safety device if the vehicle is driving fast. In such cases, depress the brake pedal and reduce the vehicle speed.

 **CAUTION**

Do not let the engine overrev when driving downhill. Doing so could cause place stress on the engine components, and cause damage to the engine. Limit the speed so that the tachometer needle does not enter the red zone.

NOTE:

“Overrev” refers to an operating state of the engine in which it rotates at an RPM higher than the recommended maximum RPM. Overrevving the engine could lead to an engine failure.

ON ROUGH ROADS AND IN BAD WEATHER**WARNING**

- Use the manual shift mode when driving on slippery surfaces (such as a wet or frozen road). Using the automatic shift mode on slippery roads could cause an accident for the following reasons:
Skidding is more likely to be caused by automatic shift-downs that take place normally when driving in the automatic shift mode. Skidding also may occur easily due to automatic shift-downs following full or quick operation of the accelerator pedal. Even while driving using the manual shift mode, the vehicle is likely to skid if you suddenly depress the accelerator pedal or quickly shift down the gear.
 - Do not use the exhaust brake when the vehicle is lightly loaded or not loaded. Using the exhaust brake under these conditions could cause the tires to slip on the road surface, resulting in a skid. The tires are particularly liable to slip when the vehicle is traveling downhill.
 - Reduce the vehicle speed before negotiating a curve while braking. If the tires slip due to the road surface being slippery or when the vehicle passes over a step in the road, the ABS may function, causing the exhaust brake to be temporarily released, which may result in a serious accident.
-
- Use a low gear and try to drive at a constant speed when driving on gravel roads or muddy roads.
 - Do not race the engine when attempting to get the vehicle out of mud, snow, or sand. Racing the engine is useless and even makes the situation worse as the spinning wheels make deeper ruts. If your vehicle becomes stuck in mud, snow, or sand, it can often be moved using a rocking motion. Turn the steering wheel right and left to clear the area around the front wheels. Then shift back and forth between “D” and “N”, while lightly pushing the accelerator. Use the minimum amount of accelerator pedal pressure that will maintain the rocking motion, without spinning the wheels or racing the engine.

 **CAUTION**

When attempting to free a stuck vehicle, do not operate more than 5 minutes since it causes the transmission oil or clutch to heat up rapidly.

- Drive very slowly on bumpy roads and take care not to allow the undercarriage to bottom out. When the muffler strikes a rock or other obstacle, its internal catalyst and ceramic filter may be damaged. Have it checked by an authorized dealer.
- Avoid sudden steering and sudden braking on roads which are slippery from rain. Conditions are especially dangerous just after it begins to rain. Use engine braking and the exhaust brake together with the wheel brakes to decelerate. Note, however, that sudden engine braking can cause a skid. Drive at a speed at which you can stay comfortably in control of the vehicle.
- When the vehicle is driven through puddles or washed with water, braking performance can be reduced by water splashed over the brake discs. In this event, drive slowly with light pressure on the brake pedal to dry out the brakes. Pay attention to nearby vehicles while doing so.
- Avoid driving when the road is covered with water due to torrential rain or other causes. Should your vehicle be flooded by water, have it inspected by an authorized dealer as soon as possible.
 - If water gets into the engine, it can cause engine damage.
 - If water gets into the high-current fuse box, it can cause a short circuit that may result in a fire.
 - If water gets into wheel hub bearings, king pins, tie rod ends, and the components around them, it can cause the bearings and other parts used in them to be rusted and ultimately to seize up.
 - If water gets into the muffler, the catalyst, ceramic filter and sensors could be damaged.
- In fog, turn on the fog lamps* and drive carefully at low speeds, paying attention to the center line and the vehicle ahead of you.
- When driving in snow or on frozen roads, use tire chains (except FG model vehicles), snow tires or studless snow tires and drive at a moderate speed. Avoid sudden braking and sharp turns.

*: If equipped

PARKING **WARNING**

- Park the vehicle on a level, flat surface if possible. Do not park on a slope. If it is unavoidable to park the vehicle on a slope, do the following: Firmly apply the parking brake while fully depressing the brake pedal, place the gearshift lever in the “P” position, and chock the wheels. Turn the steering wheel toward an obstruction (like a curb stone) for increased safety in case the vehicle moves.
- Do not park the vehicle only with the gearshift lever placed in the “P” position; always firmly engage the parking brake. If you park the vehicle on a steep slope only by placing the gearshift lever in the “P” position without also engaging the parking brake, the gearshift lever will become extremely difficult to move or, in the worst case, it may be impossible to release the transmission from the locked state. If this happens, shift the gearshift lever into the “N” position and then, after making sure the gear position indicator shows “N”, move the lever to the “D” position.
- Pull up the parking brake lever all the way to properly apply the parking brake. There is no relationship between illumination of the BRAKE warning lamp and the parking brake. Pulling the lever insufficiently will not apply the parking brake properly, and the vehicle could move while parked and cause a serious accident.
- The engine and exhaust pipe are extremely hot immediately after the vehicle has been driven. Do not park the vehicle in any place where there is dry grass, waste paper, or other flammable material.
- Always stop the engine before sleeping in the cabin. You could otherwise cause an accident by unintentionally moving the accelerator pedal or shift lever while sleeping. Also, you could suffer carbon-monoxide poisoning from exhaust gases if the vehicle is parked in a closed space.

 **WARNING**

- Never leave lighters, spray cans, cans of carbonated drinks, glasses or other objects in the cabin when parking the vehicle in the hot sun. The cabin will heat up, which may cause flammable items such as lighters and spray cans to spontaneously ignite and cans of carbonated drinks or beer to explode. The heat could also cause cracks or deformation of plastic lenses or the plastic film that coats lenses.
- When leaving the vehicle, take with you any children or pets who were riding in the cab. Never leave children or pets in the cab. A child left in the cab could interfere with the vehicle, causing it to move or catch fire. Also, the cab gets extremely hot in sunshine and in hot weather so a child left in the cab could suffer heatstroke.
- The body as well as inside equipment and controls of a vehicle parked in sunshine for a long time could become hot enough to burn you. Do not touch hot parts directly with bare hands; use a cloth or appropriate material in between.
- Always use the mirrors to confirm safety before opening a door. Suddenly opening a door is dangerous because the door may obstruct cars, motorcycles, bicycles, and pedestrians coming from behind.

1. With the vehicle at a complete stop, pull the parking brake lever while fully depressing the brake pedal, and then place the gearshift lever in the "P" position.
2. After allowing the engine to idle for three minutes, if possible, turn the engine off.
3. To help prevent theft and the battery from discharging, be sure to remove the starter key and lock the doors.

NOTE:

A buzzer sounds continuously if the driver's door or assistant driver's door is opened while the engine is running and the gearshift lever is in the "D" position. The buzzer stops if the gearshift lever is moved to the "P" or "N" position, the engine is stopped, or the door is closed. If the gearshift lever is moved to the "R" position while the engine is running, the buzzer sounds intermittently. Always stop the engine with the gearshift lever in the "P" position.

⚠ CAUTION

- Engine components are particularly hot immediately after the vehicle has been driven uphill or on an expressway. Allow the engine to idle for 3 minutes or more before turning the engine off, if possible. This allows the engine coolant to cool to a normal operating temperature. →  P. 5-12
 - Leaving the vehicle sitting for a long time with the starter switch in the "ON" or "ACC" position could result in a dead battery.
 - Be sure to turn off all lights after parking to prevent the battery from discharging.
4. If parking on a slope is unavoidable, block the wheels securely with chocks and take any other necessary measures to prevent the vehicle from moving.

VEHICLES WITH LIMITED SLIP DIFFERENTIAL *

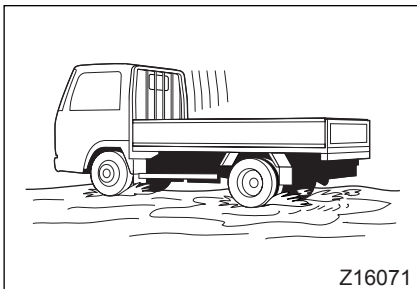

The limited slip differential performs a special function in addition to the ordinary differential function which is needed when the vehicle is in a turn. When one wheel begins to spin on a slippery surface, the limited slip differential provides most of the driving force to the wheel which is not spinning automatically stopping the spinning and providing traction to the vehicle.

This function is effective when driving on bumpy or snow-covered roads, and useful when moving the vehicle out of mud.

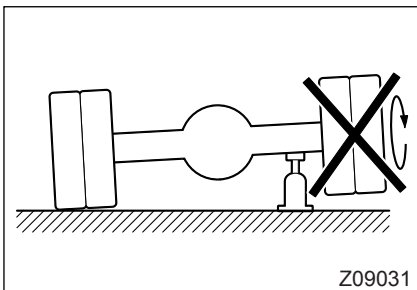

⚠ WARNING

When you raise the vehicle on one side for replacing a tire or any other purpose, never rotate the raised wheel. Doing so is dangerous as power is transmitted to the wheel which is on the ground and the vehicle could move.

⚠ CAUTION

Use only the special oil designed for limited slip differentials if your vehicle is equipped with a limited slip differential.

*: If equipped (standard on FG)

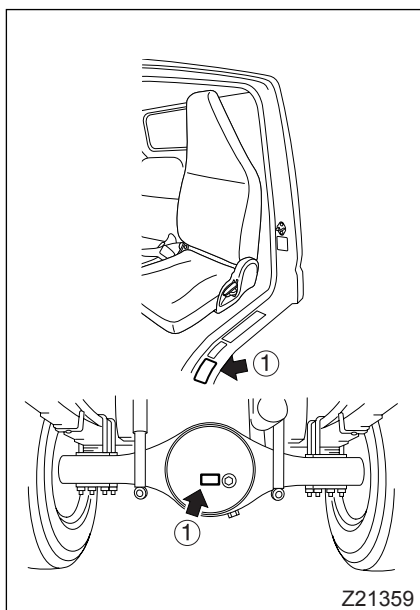
**NOTE:**

A vehicle with limited slip differential can be identified by precautionary stickers ① near its driver's seat and on the rear axle housing.

The limited slip differential functions automatically, but you are recommended to pay attention to the following points:

- On slippery road surfaces, aggressively depressing the accelerator pedal during a turn may cause the vehicle to skid and lose balance.
- Using tires different in air pressure or outside diameter between the right and left wheels may result in pulling the vehicle to one side during acceleration or uneven wear of tires. Check the tires regularly to make sure the right and left ones are inflated to the same pressure and not different in outside diameter.
- Distribute the load weight evenly. If the load is heavier at the rear, the vehicle's tendency to move in a straight line will slightly increase.

LOADING CARGO

1 Do not overloading the vehicle.

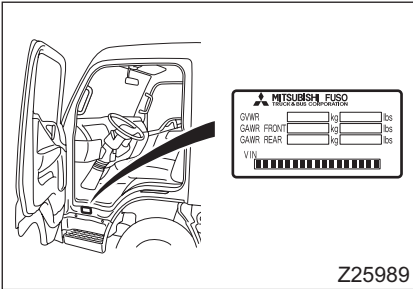

- Overloading the vehicle causes braking performance to deteriorate and can cause an accident. Also, overloading the vehicle places excessive stress on vehicle parts, shortening their service lives. The vehicle is designed to perform best when loaded within its Gross Vehicle Weight Rating (GVWR) and within its front and rear Gross Axle Weight Ratings (GAWR). Try not to exceed these ratings.
- The vehicle's GVWR, front GAWR, and rear GAWR are listed on the VIN plate that is located as shown in the illustration.

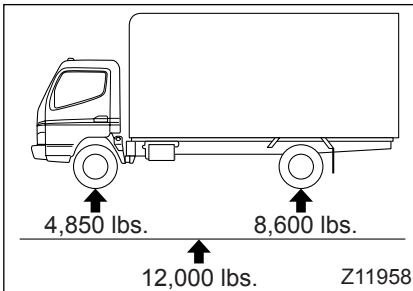

NOTE:

Loading to a weight almost equal to a total of the front and rear GAWRs may exceed the GVWR. For example, a vehicle with a GVWR of 12,000 lbs. (5,445 kg) has a front GAWR of 4,850 lbs. (2,200 kg) and a rear GAWR of 8,600 lbs. (3,900 kg). Added together, the GAWRs total 13,450 lbs. (6,100 kg), thus exceeding the GVWR. Be sure neither the GAWRs nor GVWR are exceeded.

! WARNING

- Overloading the vehicle can damage the vehicle and make safe driving difficult. For safety, never overload.
- The GVWR and GAWRs pertain to the maximum load the vehicle can physically carry. Please also abide by state and regional loading limit requirements.
- Do not carry passengers in the cargo area while the vehicle is in motion.

2 How to load cargo

Improperly loaded cargo is unstable and may cause uneven weight distribution. If the weight is concentrated in one place, it may damage the cargo deck and frame or burst a tire.



WARNING

- If the tail lamps or rear turn signal lamps are hidden by covers (such as the cargo deck gate) when roping up cargo on public roads, set up reflective triangles or other equipment in an easy-to-see location to provide sufficient warning to traffic approaching from the rear and other traffic. Hidden tail lamps or other lamps could make it difficult for the traffic approaching from the rear to notice the vehicle and could cause an unexpected accident.
- Do not let ropes or the edge of covers hang between the cabin and the cargo deck, and do not insert timber or other flammable objects between the cargo deck and frame. Doing so could cause a fire due to heat from the engine or exhaust pipes.
- When spreading the tarpaulin, take care not to let it cover or be drawn into the engine air intake duct, as this will reduce engine output and could cause an engine failure.
- The cargo should be prevented from moving and also securely fixed with wire, etc. so that it will not slide during driving.
- Do not place wooden boards or other items between the cargo bed and frame. The heat from the exhaust pipe could set fire to them.

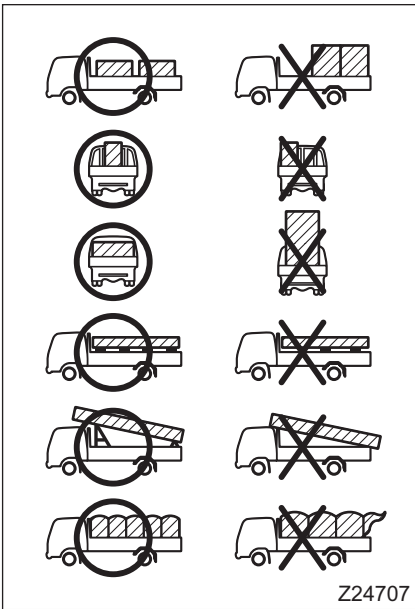

- Place the cargo evenly on deck.
- Avoid cargo being piled up too high. If cargo is piled high, the vehicle is at risk of rolling over upon being hit with a side wind or making a turn.
- If you place supports under the cargo, position them at equal intervals.
- Avoid allowing long objects to protrude over the rear edge of the cargo deck. Use suitable supports when loading long objects. Do not support them only with the gate and the rear edge of the cargo deck.
- To prevent cargo from falling, strap it down securely and cover it with a tarpaulin. Secure the tarpaulin ends neatly so they do not flap.

CAUTION

Loading or unloading cargo using a lifting magnet may deteriorate the performance and the function of the vehicle due to malfunction of sensors.

8. 4WD OPERATION <FG models>

CONTROL AND INDICATOR LAMPS FOR 4WD OPERATION 8-2
ADVICE ON USE OF THE 4WD MODE 8-6
PRECAUTIONS TO BE TAKEN WHEN SELECTING THE 4WD MODE 8-8

CONTROL AND INDICATOR LAMPS FOR 4WD OPERATION

Select the 2WD (rear-wheel-drive) mode or 4WD (all-wheel-drive) mode as necessary for the condition of the road surface. The 4WD mode can be used for extra traction on rough road surfaces and on snow-covered road surfaces (in mountainous regions, for example).

CAUTION

- This 4WD vehicle is not suitable for permanent off-road application. Permanent off-road use may have an impact on vehicle's lifetime.
- With a 4WD vehicle, power is applied to both the front wheels and rear wheels; if incorrect tires are fitted, they can prevent the vehicle from performing to its full potential, and can also cause an unexpected accident. Incorrect tires can also adversely affect power-train components. Please observe the following cautions related to tires and wheels.
 - Make sure all of the tires are the specified size and are identical in terms of manufacturer, brand, and tread pattern. Be particularly careful when fitting snow tires or other winter-use tires.
 - Use tires that do not differ from each other in terms of the extent of wear.
 - Regularly check the tire inflation pressures and keep them adjusted to the specified values.
 - When tire replacement is necessary, replace all of the tires at the same time.
 - Use genuine wheels. Do not change the wheel size.
 - To ensure that the tires wear evenly, rotate the tires every 30,000 km (18,000 miles).

When towing the vehicle, raise the front wheels off the ground and disconnect the propeller shaft at the end closer to the rear wheels.

The 4WD mode is not recommended for driving on dry paved roads as the tires may wear down prematurely, the running noise may increase, and more fuel may be consumed. Malfunction of the drive train components may also result. Be sure to drive in the 2WD mode on dry paved roads.

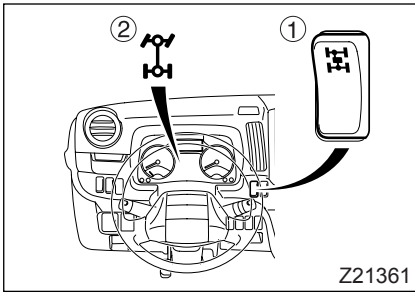

1 Location of control and indicator lamps

- ① Front drive switch
- ② 4WD indicator lamp

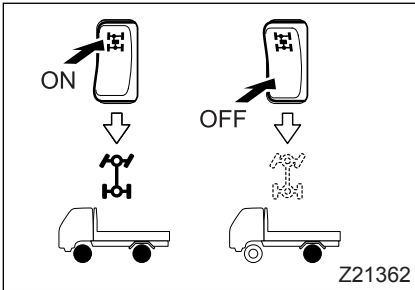

1.1 Front drive switch

The front drive switch is used to select either the two-wheel drive (2WD) mode that uses only the two rear wheels as driving wheels or the four-wheel drive (4WD) mode in which the engine power is transmitted to all four wheels. Toggle this switch to “ON” to select the 4WD mode; toggle it to “OFF” to select the 2WD mode. The 4WD indicator lamp illuminates when the 4WD mode is selected.

CAUTION

Make sure that the free-wheeling hubs on both the front wheels are in the “LOCK” position when the 4WD mode is selected; in the “FREE” position, the engine power is not transmitted to the front wheels.

⇒  P. 8-5

2 Selecting drive mode-transfer gear range combinations

You can select any desired drive mode and transfer gear range combination from among those shown in the following table. Select the most suitable combination according to the driving conditions.

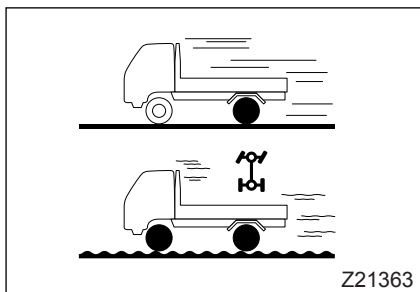

Mode-range combination	Illuminated indicator lamp	Driving conditions
2WD	—	Normal road driving
4WD		Driving on snow-covered, frozen, or sandy roads or other difficult roads where running in the two-wheel drive mode is inappropriate.

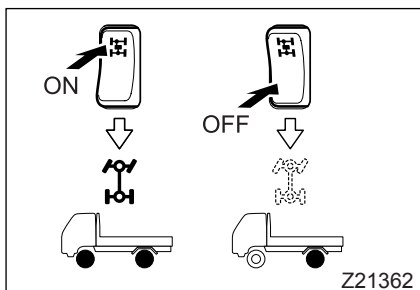

3 Switching the mode-range combination

• 2WD to/from 4WD

1. Make sure that the free-wheeling hubs on both front wheels are in the "LOCK" position. ⇒ P. 8-5
2. Press the front drive switch either at the "ON" side (4WD) or "OFF" side (2WD) when the vehicle is either in motion or stationary.

NOTE:

- The vehicle can be switched between 2WD/4WD mode when it is either driving or stopped.
- If it is difficult to switch from 2WD mode to 4WD mode and vice versa, release the accelerator pedal and then depress it again lightly. This will facilitate the switching.
- During switching from 4WD mode to 2WD mode, the system may remain in 4WD mode even after the  indicator lamp has gone out. If this happens, release the accelerator pedal and depress it again lightly. The switching will then take place.

4 Free-wheeling hub

- Even when the 4WD vehicle is running in the two-wheel drive mode with the engine power transmitted only to the rear wheels, the front wheels are always connected to the power train (differential, propeller shaft and transfer). The free-wheeling hub is a device to release the wheels from the power train to allow them to rotate freely, saving energy and improving power economy.

- Set the free-wheeling hub as follows:
- To drive the vehicle in the 2WD mode, set each free-wheeling hub to the "FREE" position ①.
- To drive the vehicle in the 4WD mode, set each free-wheeling hub to the "LOCK" position ②.

When the 4WD mode is selected, ensure that the free-wheeling hubs on both front wheels are set in the "LOCK" positions. Should either or both of them be in the "FREE" position, four-wheel driving is not possible.

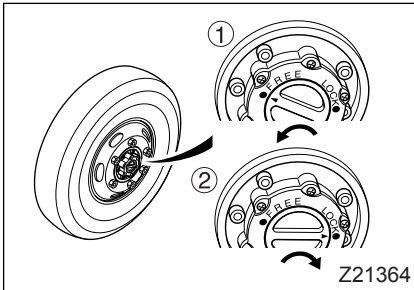

⚠ WARNING

- **Never drive with one free-wheeling hub in the "FREE" position and the other in the "LOCK" position. Doing so is very dangerous.**
- **The free-wheeling hub may be extremely hot after driving. Do not touch it.**

ADVICE ON USE OF THE 4WD MODE

When you select the 4WD mode to drive on off-road terrain (sandy or muddy ground) or snow-covered or frozen roads, take sufficient care to avoid inappropriate operation.

1 Driving on snow-covered or frozen roads

Select the 4WD mode if necessary for the snow or road surface conditions. Start out slowly.

Tire chains cannot be used on both front and rear wheels. You are advised to use snow or winter tires.

2 Driving on sandy or muddy ground

- Select the 4WD mode if you find it appropriate to do so after checking sand or mud conditions. Start out slowly. Drive at low speeds, keeping the speed as constant as possible.
- Avoid quick acceleration, sudden braking and sharp turns as they can cause the vehicle to become stuck in the sand or mud, making it impossible to free the vehicle by yourself.
- Muddy conditions are generally difficult to judge and there is danger of becoming stuck in deep mud. To prevent this, drive as slowly as possible and, if necessary, get out of the vehicle and check the conditions.

3 Climbing steep hills

Select the 4WD mode to make full use of engine torque. Choose the path that has the least stones, sand and bumps. At both the start and end of a climb, moderate slopes are preferable.

4 Descending steep hills

- Select 4WD mode and descend slowly using engine braking so that the wheels do not slip.
- Quick braking can slip the wheels and result in a loss of vehicle control. Check road conditions before descending.
- Avoid gear shifting when descending a hill. Select the best gear in advance, and maintain the gear until the end of the descent.

5 Crossing a river

CAUTION

- **Do not drive in water. Driving in water can cause the following problems:**
 - **Water can get into the rear axle.**
 - **Water can get into the high-current fuses, resulting in a short circuit that causes a fire.**
 - **Water entering the transmission could cause the DUONIC[®] system to stop operating normally.**
- **Never shift gears while crossing a river.**

Although 4WD has many advantageous features, it is not designed for driving in water. If it is absolutely necessary to drive in water, select the 4WD mode and drive as described below to get out of water in the shortest possible time.

After driving in water, promptly have the vehicle inspected by an authorized dealer.

- Choose a path where water is shallowest and drive slowly to avoid making waves.
- After crossing, check the brakes. If the brakes do not operate effectively, drive slowly and lightly depress the brake pedal to dry the brakes while remaining aware of any vehicles in front of or behind you.
- After crossing, check the electric system for any problems that the water may have caused. Also observe the recommendations in the following sub-paragraph describing precautions to be taken when selecting the 4WD mode.

**PRECAUTIONS TO BE TAKEN WHEN
SELECTING THE 4WD MODE**

- In the 4WD mode, you may feel the steering wheel move differently from the way it does in the 2WD mode.
Operate the steering wheel carefully until you get the complete feel of 4WD operation.
- When turning a sharp corner at a low speed in the 4WD mode, a condition resembling one that would occur during braking can develop. This condition called “sharp corner braking” is caused by the fact that the four tires are moving along circles of different radiuses and is a phenomenon limited to 4WD vehicles. It does not imply any abnormal condition exists. If you experience this condition, either straighten steering wheel or switch to the 2WD mode.

1 If you have driven in water by necessity

- If you have driven in water by necessity, promptly have the vehicle inspected by an authorized dealer.
- Immediately check the engine oil, clutch control fluid (ATF), transmission oil, transfer oil, and differential oil. If the oil looks milky, it is contaminated with water. Be sure to replace it.
⇒  P. 7-15
- If water has entered the cab, dry the carpet, etc. Leaving them wet can cause rusting.

2 After off-road driving, be sure to check the following:

- Check for damage caused by stones, etc.
- Check the brakes. If the brakes function poorly, have them checked by an authorized dealer.
- Grease the propeller shaft and also the front and rear suspension springs.
⇒  P. 12-18

9. CLIMATE CONTROL SYSTEMS

FRONT AIR OUTLETS 9-2

REAR AIR OUTLETS *1 9-3

MANUAL AIR CONDITIONER *1 9-4

FULLY AUTOMATIC AIR CONDITIONER *1 9-10

REAR HEATER *1,2 9-16

OUTSIDE AIR INLETS 9-16

*1: If equipped

*2: Crew-cab vehicle

FRONT AIR OUTLETS

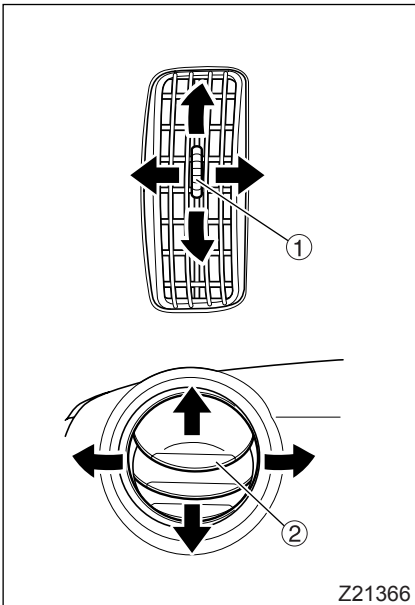
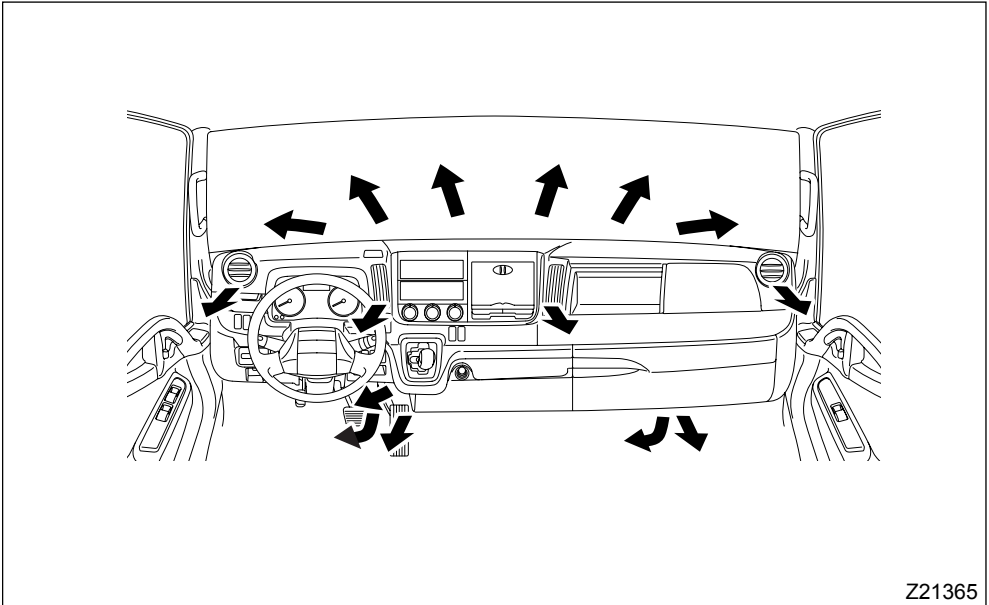

1 Adjusting the airflow direction

- Adjust the up/down direction of airflow from each outlet as desired by moving the knob ① or fin ② up or down.
- Adjust the left/right direction of airflow from each outlet as desired by pressing the right or left side of the outlet.
- Close each outlet by moving the knob or fin fully downward. The outlet opens if the knob or fin is moved upward.

NOTE:

Avoid placing anything between the windshield and instrument panel, as it will block the necessary airflow toward the windshield.

REAR AIR OUTLETS *

Air outlets in vehicle equipped with rear heater

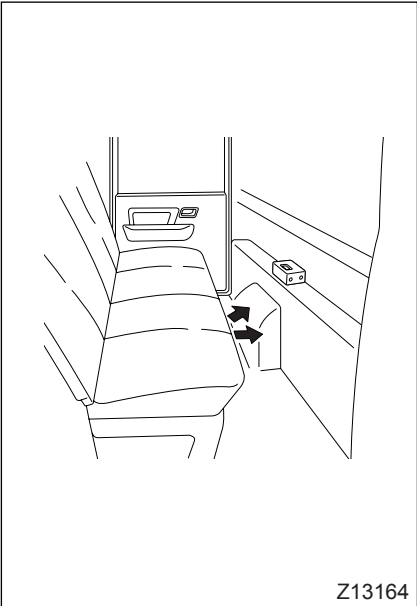

Z13164

*: If equipped

MANUAL AIR CONDITIONER * **WARNING**

Never leave children alone in the vehicle. If the air conditioner stops for some reason or other, the temperature inside the vehicle will rise, and can cause heatstroke, for example.

 **CAUTION**

To protect the environment, your vehicle's air conditioning system uses refrigerant HFC-134a which does not harm the ozone layer.

Since charging the system with this refrigerant requires a method different from the conventional method, be sure to contact your nearest authorized dealer if your system needs to be serviced.

NOTE:

- *The heater uses heat produced by the engine coolant. Warm air is not available until the coolant becomes heated.*
- *When you perform the parked DPF regeneration, probably causing the air conditioning system to stop. You may then feel reduced air conditioning performance, but this does not indicate any abnormality. The air conditioning system will automatically restart functioning normally as soon as the engine compartment temperature drops to a normal temperature following the termination of the DPF regeneration.*
- *In some vehicles, a fast idling device increases the engine's idling speed slightly when the air conditioner is used.*
- *Do not release refrigerant into the atmosphere. When necessary because of servicing or scrapping of the vehicle, consult the nearest authorized dealer in order to have the refrigerant properly removed.*

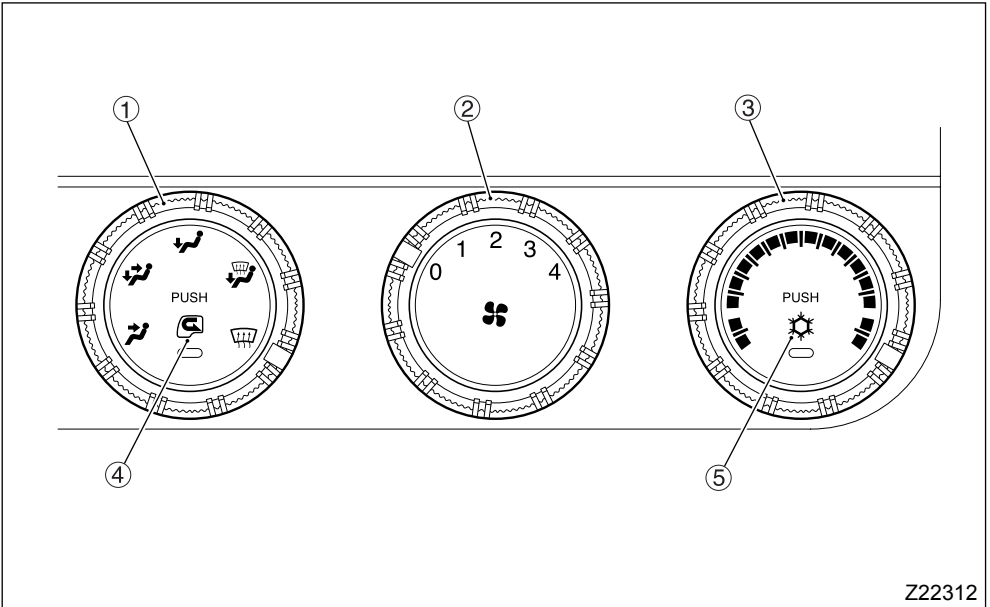
1 Control panel

Z22312

- ① Mode selector dial
- ② Fan speed dial
- ③ Temperature adjustment dial
- ④ Air selector switch
- ⑤ Air conditioner switch

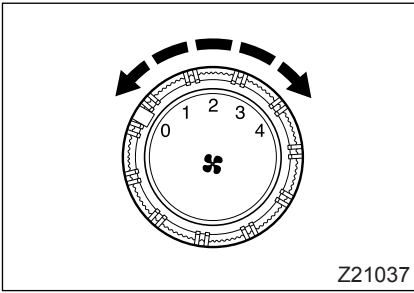

1.1 Fan speed dial

Fan speed dial allows you to select 4 fan speeds. Select the desired speed.

- 0: Off
- 1: Breeze
- 2: Low
- 3: Medium
- 4: High

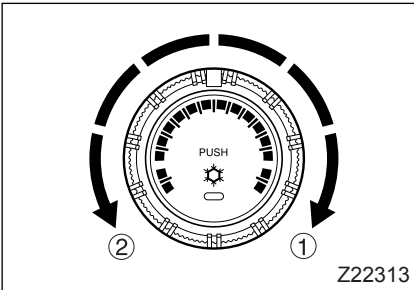

1.2 Temperature adjustment dial

Turn the dial in the direction of arrow ① to increase the air temperature and in the direction of arrow ② to decrease it.

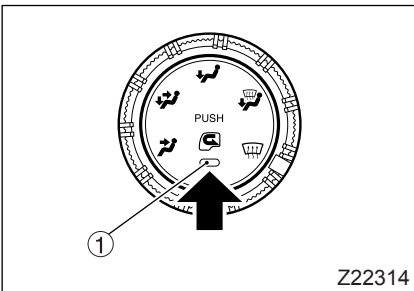

1.3 Air selector switch

Pressing the air selector switch allows you to toggle the setting between recirculation of inside air and introduction of outside air. When recirculation is selected, the indicator lamp ① in the switch illuminates.

- Outside air
Use this setting when driving in normal conditions.
- Recirculation
Use this setting when the outside air is dirty. Using this setting when parked enables you to prevent dust from entering the cab.

⚠ CAUTION

Using the recirculation setting for a long time will cause air to become stale. If this happens, switch to the outside air setting.

NOTE:

- Select outside air when driving in normal conditions.
- Using the recirculation setting for a long period when humidity is high makes the windows prone to fogging.
- If the air selector switch is pressed with the starter switch at "OFF", the setting will not change until the starter switch is turned to "ON".

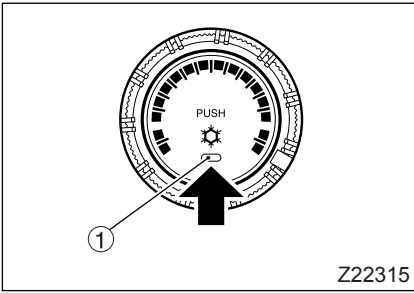

1.4 Air conditioner switch

Pressing the air conditioner switch activates the air conditioner, which has cooling and dehumidifying functions. The indicator lamp ① in the switch illuminates at this time. Pressing the air conditioner switch once more stops the air conditioner.

NOTE:

- If the air conditioner switch is pressed with the starter switch at "OFF", the air conditioner will not start until the starter switch is turned to "ON".
- If the air conditioner switch is pressed when the fan speed dial is turned to the "OFF" position, the air conditioner will not start until the fan speed dial is turned to an operating position.

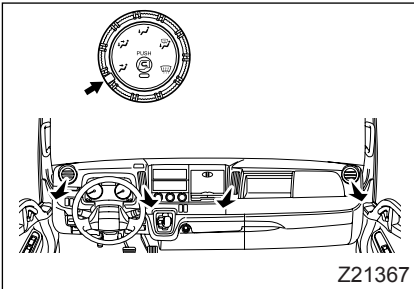

1.5 Mode selector dial

Use the mode selector dial to select outlets as desired.

-  For airflow toward the upper body

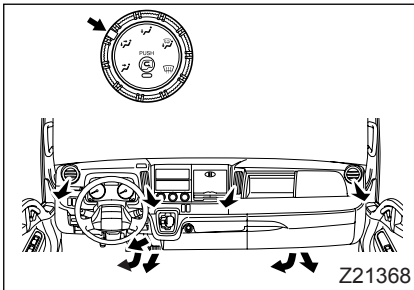

-  For airflow toward the upper body and toward the feet

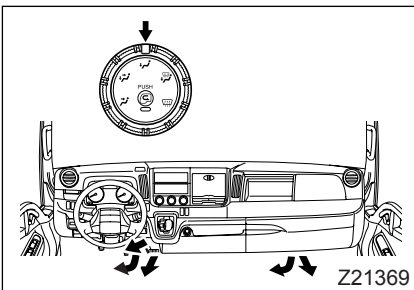

-  For airflow toward the feet

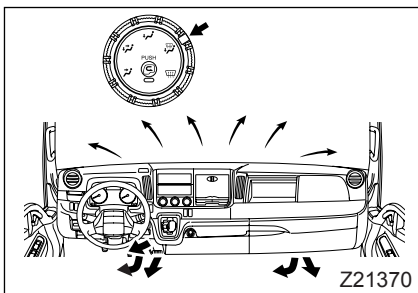

-  For airflow toward the feet and toward the windshield

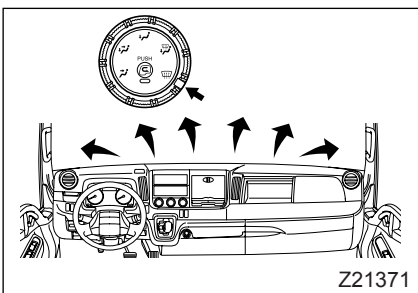

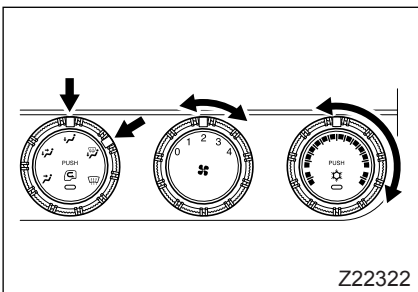

-  For airflow toward the windshield





2 Using the controls

2.1 To heat the cab

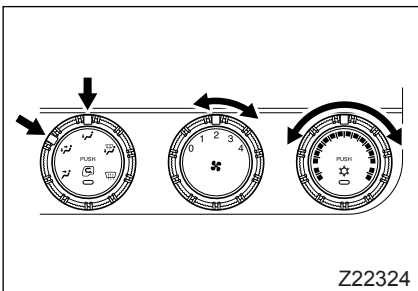
Place the mode selector dial in the  position or in the  position.



2.2 For cool airflow toward the head and warm airflow toward the feet

Place the mode selector dial in the  position or in the  position.

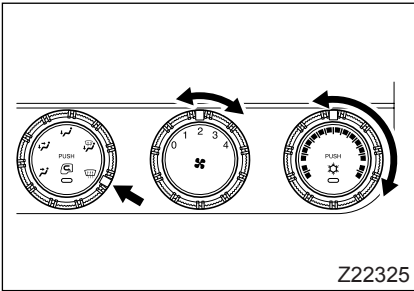

2.3 To defog the windshield

Place the mode selector dial in the  position. If you wish to defog the windshield quickly, use the fan speed dial to select the maximum fan speed and use the temperature adjustment dial to select the maximum temperature.

NOTE:

Using the air conditioner will quickly defog the windshield due to its dehumidifying effects.

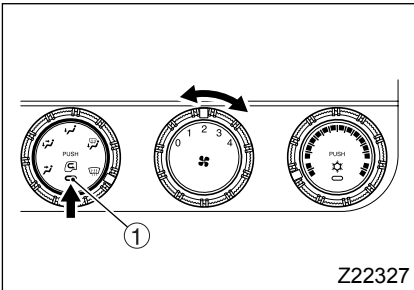

2.4 To ventilate the cab

Press the air selector switch to select outside air, and place the mode selector dial in the  position. When the mode switches to outside air, the indicator lamp ① in the switch extinguishes.

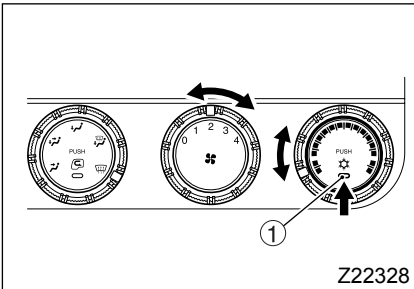

2.5 To cool the cab

Press the air conditioner switch to activate the air conditioner, then use the temperature control dial to set a comfortable temperature. The indicator lamp ① will be illuminated while the air conditioner is operating.

3 Cleaning the air filter

Clean the air filter every 6 months.

A dust clogged air filter may cause a poor air conditioning performance and blower motor malfunction.

⇒  P. 12-94

**FULLY AUTOMATIC
AIR CONDITIONER *** **WARNING**

Never leave children alone in the vehicle. If the air conditioner stops for some reason or other, the temperature inside the vehicle will rise, and can cause heat stroke, for example.

 **CAUTION**

To protect the environment, your vehicle's air conditioning system uses refrigerant HFC-134a which does not harm the ozone layer.

Since charging the system with this refrigerant requires a method different from the conventional method, be sure to contact your nearest authorized dealer if your system needs to be serviced.

NOTE:

- *Coolant from the engine is used in the heating unit. If the level of coolant is low, the unit will be unable to generate warm air when required.*
- *When you perform the parked DPF regeneration, the engine compartment temperature will rise, probably causing the air conditioning system to stop. You may then feel reduced air conditioning performance, but this does not indicate any abnormality. The air conditioning system will automatically restart functioning normally as soon as the engine compartment temperature drops to a normal temperature following the termination of the DPF regeneration.*
- *In some vehicles, a fast idling device increases the engine's idling speed slightly when the air conditioner is used.*
- *Do not release refrigerant into the atmosphere. When necessary because of servicing or scrapping of the vehicle, consult the nearest authorized dealer in order to have the refrigerant properly removed.*

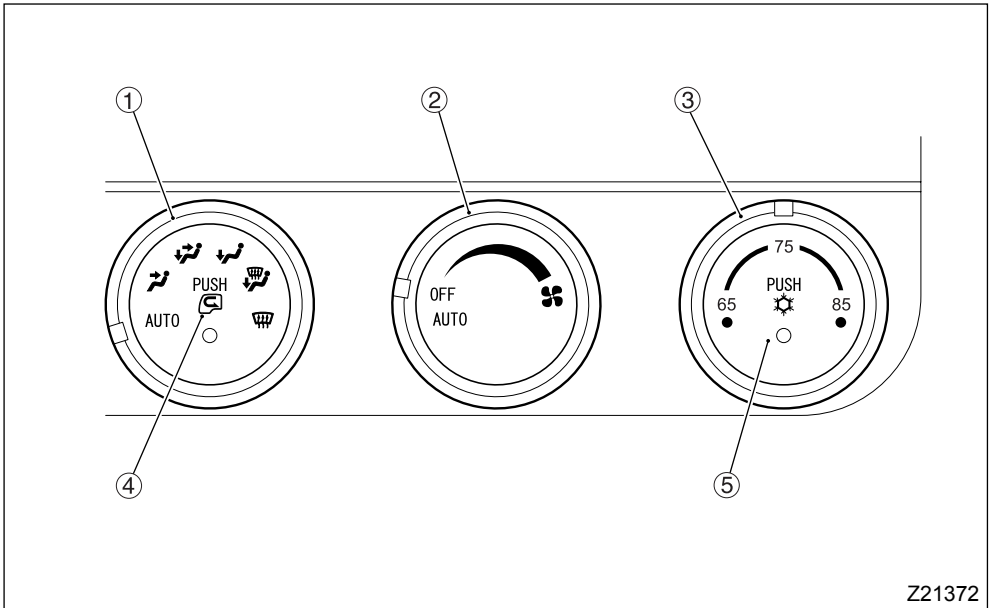

Z21372

- ① Air outlet selector dial
- ② Air volume adjustment dial
- ③ Temperature adjustment dial
- ④ Air selector switch
- ⑤ Air conditioner switch

1 Using the air conditioner automatically

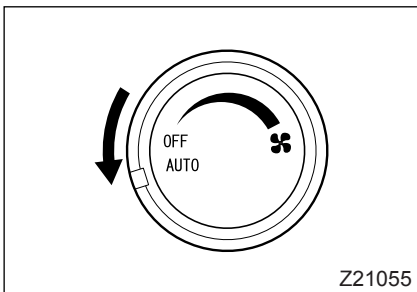

1. Set the air volume adjustment dial to "AUTO".

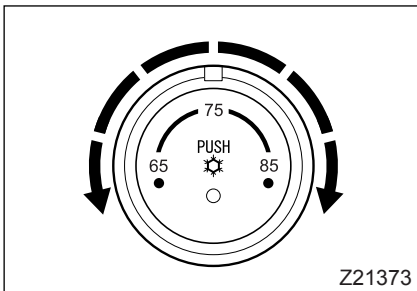

2. Set the desired temperature using the temperature adjustment dial.

You can adjust the set temperature to a value between 65°F and 85°F (18°C and 29°C).



3. Set the air outlet selector dial to "AUTO".
The air outlet (excluding  and , air volume, "ON" or "OFF" status of the air conditioner, and air selector are adjusted automatically.

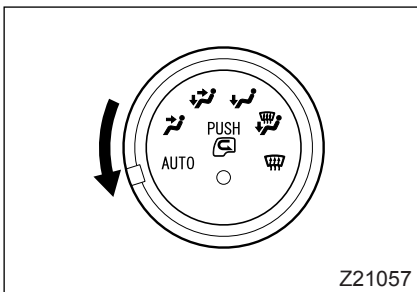

4. To stop operation, set the air volume adjustment dial to OFF.

NOTE:

- Do not place objects on the solar radiation sensor ① or cover it because this will prevent the air conditioning operation from properly sensing solar radiation.
- During "AUTO" operation, if you operate the air volume adjustment dial, the air outlet selector dial, or the air selector switch, the operated function will take priority. Functions other than the operated one will be controlled automatically.
- The automatic air selector control does not work when the air conditioner is turned off.

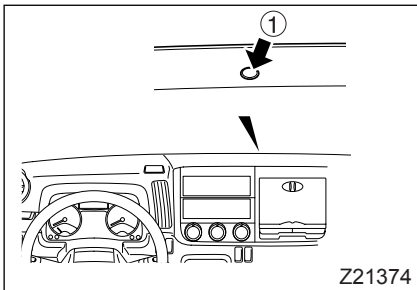

2 Using the air conditioner manually

- Operate each dial as desired.
Even during automatic (AUTO) operation, the operated function will take priority.
- Functions other than the operated one will be controlled automatically.
- To stop operation, set the air volume adjustment dial to OFF.

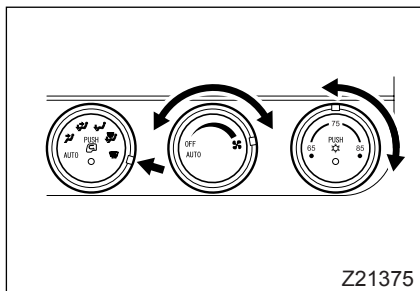

2.1 Defrosting the windshield

- When you turn the air outlet selector dial to , the air conditioner operates automatically and the air selector is switched to draw in outside air.
- To quickly defrost the windshield, set the air volume adjustment dial to maximum, and then set the temperature to maximum using the temperature adjustment dial.

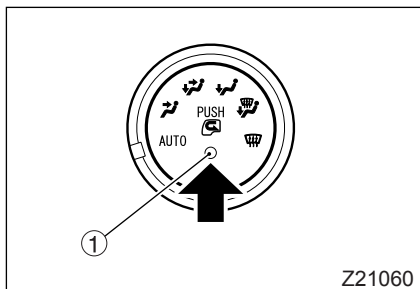

2.2 Preventing contaminated air from entering the vehicle

- Press the air selector switch to select air recirculation.
- When the mode switches to air recirculation, the indicator lamp ① in the switch illuminates.
- Each time you press the switch, the mode switches between outside air ventilation and air recirculation.

NOTE:

- *When the air outlet selector dial and the air volume adjustment dial are in the "AUTO" position, and the air selector switch is operated, the air selector function switches to manual.*
- *To put the air selector function in "AUTO", turn the air outlet selector dial or the air volume adjustment dial to a position other than "AUTO", then turn it to "AUTO" once again.*
- *Normally, use the outside air ventilation mode.*
- *When the humidity is high, if you use the air conditioner in the air recirculation mode for a long period, condensation is likely to occur on the windshield.*

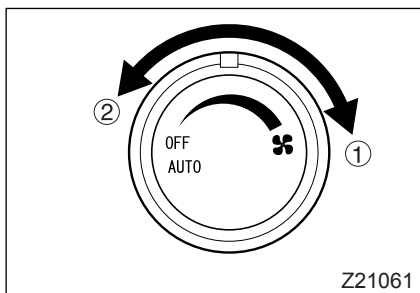

2.3 Changing the air volume

To increase the air volume, turn the air volume adjustment dial to the right, and to reduce the air volume, turn the dial to the left.

- ①: High
- ②: Low

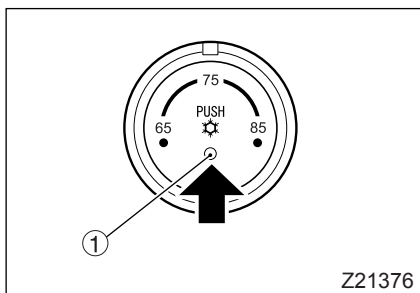

2.4 Dehumidifying and air conditioning

Pressing the air conditioner switch activates the air conditioner, which has cooling and dehumidifying functions. The indicator lamp ① in the switch illuminates at this time. Pressing the air conditioner switch once more stops the air conditioner.

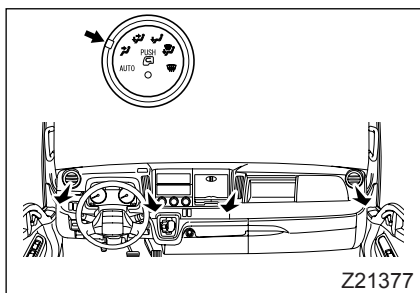

2.5 Changing over the selected air outlet

Each time you turn the air outlet selector dial, the selected air outlet changes over.

- Blowing air toward your upper body

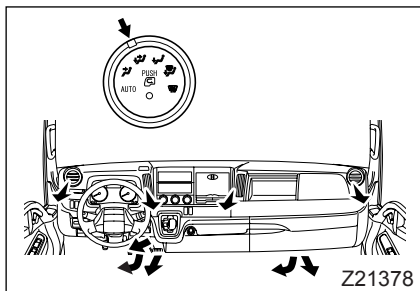

- Blowing air toward your upper body and feet

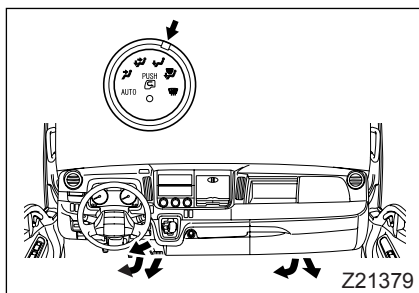

-  Blowing air toward your feet

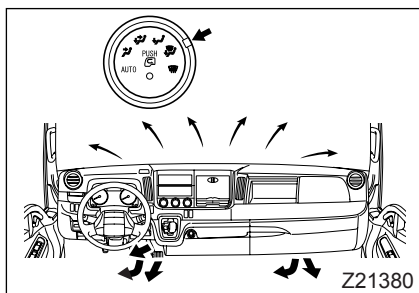

-  Blowing air toward your feet and the windshield

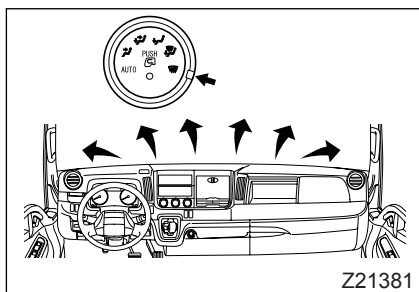

-  Blowing air toward the windshield

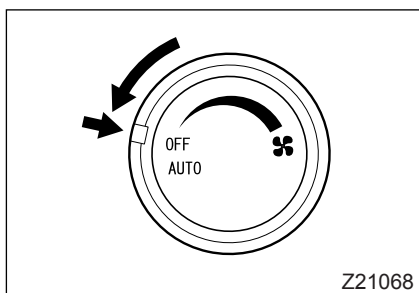

2.6 Stopping all operations

Set the air volume adjustment dial to OFF.

REAR HEATER *

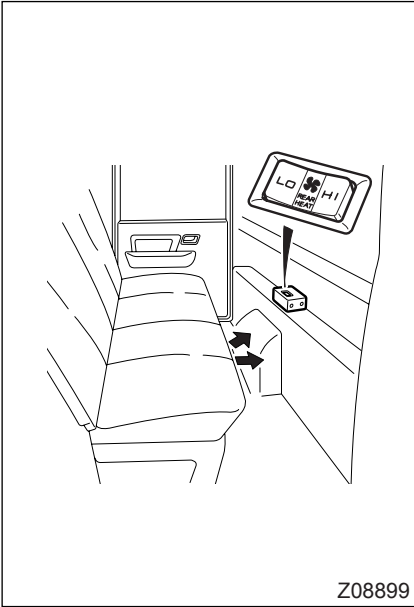

*: If equipped

<Crew-cab vehicle>

The rear heater blows warm air from below the rear seat. Select the desired blower speed by pressing the LO or HI side of the rear heater switch. When operation of the rear heater is not required, keep the switch in its middle position (with neither the LO nor HI side pressed).

NOTE:

The heater uses the heat produced by the engine coolant. Warm air is, therefore, not available until the coolant becomes heated.

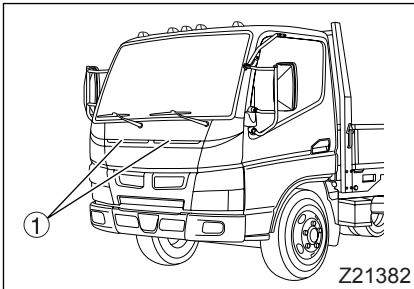

OUTSIDE AIR INLETS

- Make sure the outside air inlets ① are not covered or otherwise obstructed. Remove any object that is covering or otherwise obstructing them. Unless the inlets are unobstructed, air will not flow smoothly from the outlets when outside air is selected.
- Do not directly apply steam from a cleaner to the outside air inlets. Water could enter the cab, and the wiper motor could malfunction.

10. INTERIOR EQUIPMENT AND ACCESSORIES

CIGARETTE LIGHTER	10-2
ASHTRAYS	10-3
COAT HOOKS	10-4
SUN VISORS	10-4
INTERIOR LAMP	10-5
STEP LAMP	10-6
SMALL ARTICLE COMPARTMENTS	10-7
USING THE RADIO	10-11
AM/FM RADIO AND CD PLAYER *	10-12
ACCESSORIES	10-38

*: If equipped

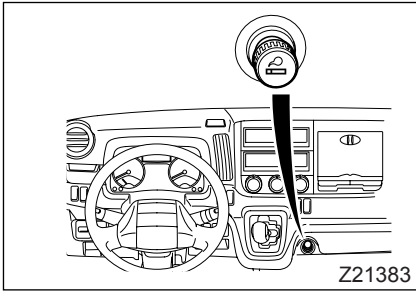

CIGARETTE LIGHTER

The cigarette lighter can be used when the starter switch is in the "ON" or "ACC" position.

Push the cigarette lighter all the way in. It will soon pop back to the original position with its core red hot. Pull out and use.

WARNING

- Do not hold the cigarette lighter in the pushed-in position since the wiring could burn out and start a fire.
- There is a malfunction with the cigarette lighter if it does not pop out within 30 seconds. Pull it out immediately by hand and have it inspected by an authorized dealer. Leaving it in the socket may cause a fire.
- Do not leave your vehicle with the cigarette lighter pushed in. Doing so could result in a fire.
- Do not allow a child to touch the cigarette lighter. The child could get burned.
- Do not touch the metallic parts of the cigarette lighter. You could get burned.
- Never use a cigarette lighter from another vehicle. Your vehicle's cigarette lighter is designed for a 12 V power supply. Do not use a 24 V cigarette lighter.
- You must replace a deformed cigarette lighter with a genuine replacement lighter or its equivalent. A deformed lighter will not pop out properly and could cause a fire.
- Do not use electric devices designed to be plugged into the cigarette lighter socket, as this could overload the circuitry and overheat the wiring, possibly causing a fire. This could also damage the inside of the cigarette lighter socket.
- If water gets into the cigarette lighter socket, it could cause a short circuit, resulting in a fire. Have the cigarette lighter socket cleaned by an authorized dealer.

ASHTRAYS

Remove and empty the ashtrays when they become full.

WARNING

- Be sure to put out cigarettes and matchsticks before putting them in the ashtrays. Close ashtrays completely. Leaving an ashtray open could cause a fire, as the heat from cigarettes or matchsticks may ignite things in the ashtray.
- Put only cigarette waste and matchsticks in the ashtray. Empty the ashtray before it becomes completely full as too much waste crammed into the ashtray could catch fire.
- Do not throw cigarette waste out of the windows since this is environmentally irresponsible and could start a fire.
- When cleaning the ashtray, do not strike it with a hard object since it could break. If the ashtray breaks, stop using it and replace it with a new one. Using a broken ashtray could cause a fire.

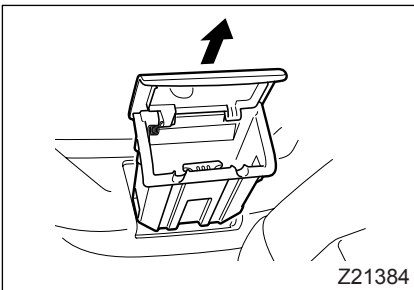

1 Driver's door ashtray and assistant driver's door ashtray

- Raise the lid to use the ashtray.
- When you wish to empty the ashtray, hold the lid and pull the entire ashtray upward to remove it.

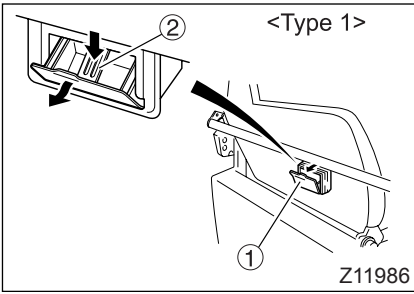

2 Rear ashtray in crew-cab model

- Pull the lid of the ashtray ① toward you for use.
- When you wish to empty the ashtray, push down the spring ② and pull the ashtray out toward you.
- To install the ashtray, insert its bottom into the groove then hold down the spring ② and push the ashtray into place.

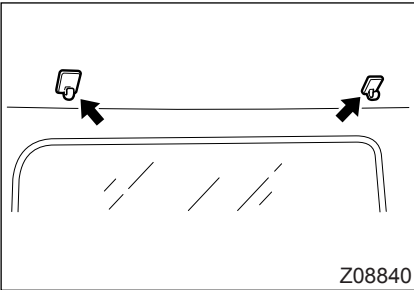
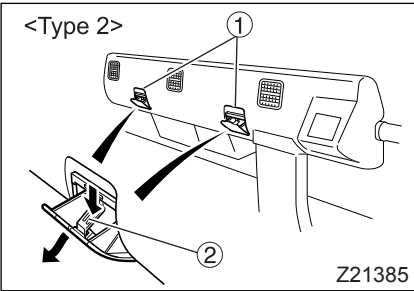

COAT HOOKS

<Vehicles other than Crew-cab models>
Use the coat hooks if you wish to hang up clothing or similar items.

! CAUTION

Do not pull the coat hooks with excessive force or hang heavy items on them. They could break.

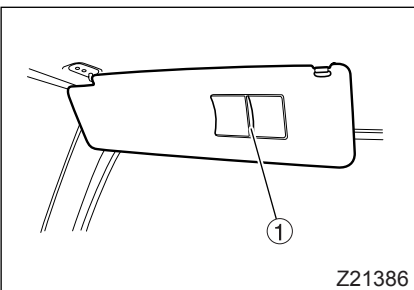

SUN VISORS

The sun visor screens your eyes from sunlight. Change its angle as needed. Unhook the inside edge of the sun visor and swing it sideways to reduce glare from the side. There is a ticket holder ① on the back of the driver's sun visor.

INTERIOR LAMP

The interior lamp(s) can be used with the starter switch in any position.

WARNING

Do not leave the interior lamp or spot lamps illuminated while driving. Otherwise, the light reflected by interior surfaces will form images on the windshield which will disturb your forward vision, increasing the risk of an accident.

CAUTION

Leaving an interior lamp illuminated for a long time with the engine not running can drain the battery to such an extent that the engine cannot be started. Always turn off the lamps before you leave the vehicle.

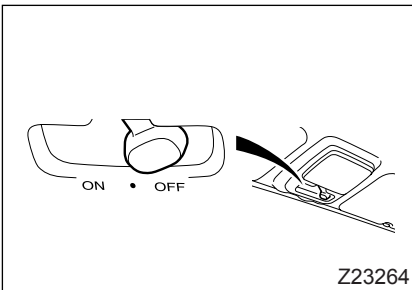

1 Interior lamp

- **“ON” position**
The lamp is illuminated regardless of the door positions.
- **“•” position**
The lamp illuminates when a door is opened and extinguishes when the door is closed.
If the engine is stopped, the lamp will gradually dim and go out 10 seconds after closing the door.
- **“OFF” position**
The lamp is off regardless of the door positions.

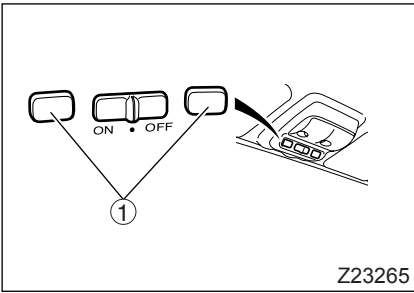

2 Interior lamp with built-in spot lamps*

- **“ON” position**
The interior lamp is illuminated regardless of the door positions.
- **“•” position**
The interior lamp illuminates when a door is opened and extinguishes when the door is closed.
If the engine is stopped, the lamp will gradually dim and go out 10 seconds after closing the door.
- **“OFF” position**
The interior lamp is off regardless of the door positions.
Spot lamp switches ①
If one of these switches is pressed, the spot lamp on the side of the pressed switch illuminates. The lamp extinguishes when the switch is pressed again.

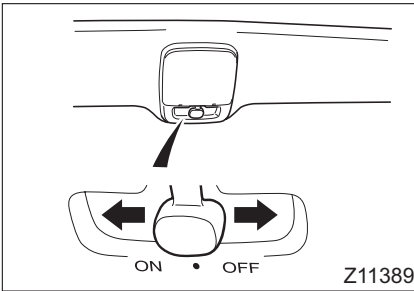

3 Rear interior lamp – Crew-cab models

- **“ON” position**
The lamp is illuminated regardless of the door positions.
- **“•” position**
The lamp illuminates when a door is opened and extinguishes when the door is closed.
If the engine is stopped, the lamp will gradually dim and go out 10 seconds after closing the door.
- **“OFF” position**
The lamp is off regardless of the door positions.

*: If equipped

STEP LAMP

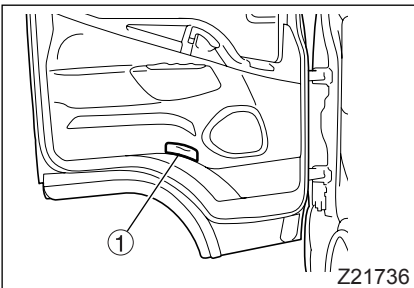

- When a door is opened, the step lamp ① on the door illuminates. The lamp extinguishes when the door is closed.
- The step lamp extinguishes about 5 minutes after opening the door under either of the following conditions:
 - The starter key is removed or in the “LOCK” position.
 - The brake pedal is not depressed.

NOTE:

The step lamp does not extinguish while the hazard warning lamps are flashing.

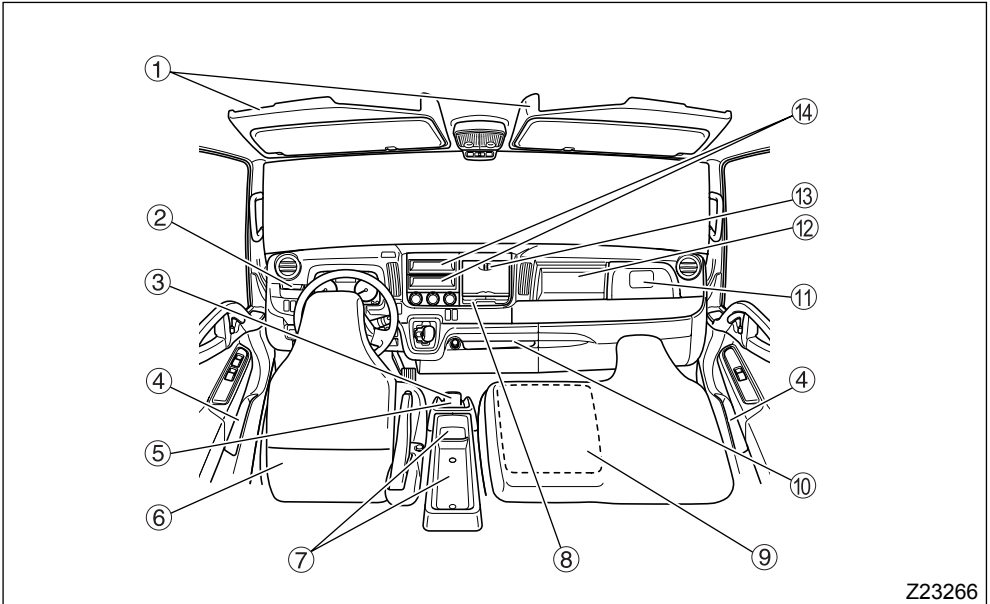
SMALL ARTICLE COMPARTMENTS

Z23266

⚠ WARNING

Always close the glove compartment before operating the vehicle. If left open, their covers could cause injury in the event of a collision or sudden stop.

⚠ CAUTION

- Fuses, relays, and other electrical items are located below the glove compartment ① and the tray ⑫. Do not splash water on the tray, and do not put wet objects in it.
- Do not use the console and tray to hold items that are prone to rolling while the vehicle is moving. Such items could create a hazard by impeding driving.

① Overhead shelf

! WARNING

Do not use the overhead shelf to hold items that are heavy and/or prone to rolling. Such items could fall down and cause injuries as the vehicle starts and stops moving.

② Vertical compartment

③ Hook

<Vehicles other than Crew-cab models>

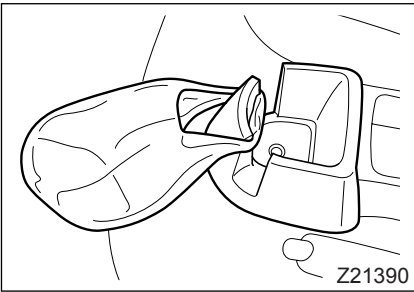

④ Door pocket

⑤ Center tray

<Vehicles other than Crew-cab models>

⑥ Seatback pocket

NOTE:

Avoid putting bulky items in the seatback pocket or pulling hard on the pocket. Doing so could break the seat covering.

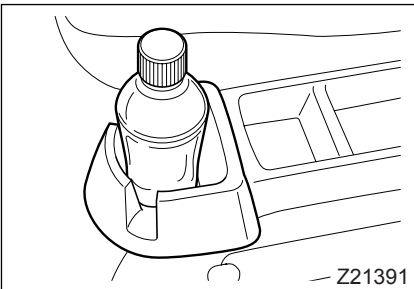

⑦ Center console box

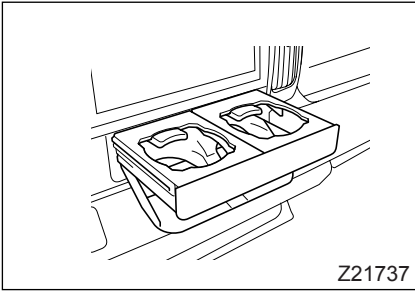

⑧ **Cup holder**

Pull out the cup holders to use them. Keep them pushed in when they are not being used.

! WARNING

- The contents in a cup or can held in the cup holder may spill during movement of the vehicle. Be careful of scalding if they contain hot beverages.
- Do not spill any water or drink over the switches and electrical equipment around the driver's seat, as wet electrical devices could malfunction and even cause a fire. If you spill a drink or water over electrical devices, have your vehicle inspected by your nearest authorized dealer.

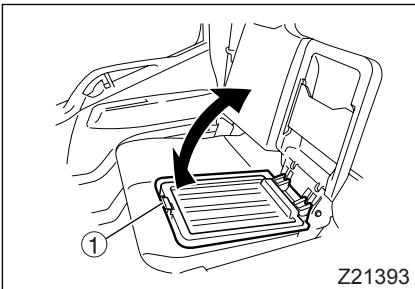

⑨ **Center tray with magazine rack**

<Vehicles with a center tray with magazine rack>

Pull the lever ① on the center seat to fold the seatback. You will then be able to use the center tray and magazine rack.

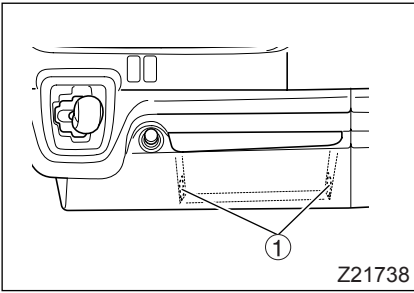

⑩ Lower pocket

NOTE:

If you accidentally drop something like a pen into the lower pocket, take it out through one of the holes ① that open at both sides of the pocket's inside bottom using a long, thin rod or similar object.

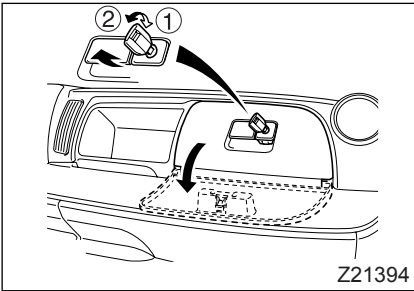

⑪ Key-locked glove compartment

- ① Lock
- ② Unlock

⑫ Tray

⑬ Box with lid (2DIN)

⑭ Pocket

The pocket may be used as a radio or other audio equipment mounting space.

USING THE RADIO

The radio (optional) can be used with the starter switch in the "ON" position or "ACC" position.

CAUTION

Using the radio for an extended period without the engine running could drain the battery.

- Extend the antenna before using the radio. Retract the antenna when it is likely to cause an obstruction, for example, when tilting the cab.
- The signal strength changes while driving, so the radio reception may become erratic.

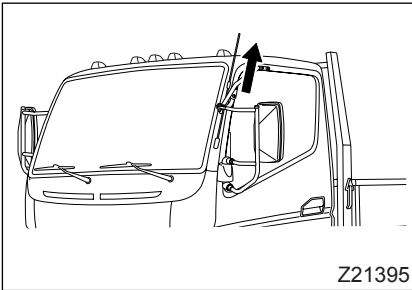

AM/FM RADIO AND CD PLAYER *

1 Before using the AM/FM radio and CD player

CAUTION



- Do not put coins or any other objects in the disc slot of the CD player.
- Press the buttons gently; pressing them roughly could cause system malfunctions. Also, avoid touching the display screen (LCD).

NOTE:

- After parking for a long time in direct sunlight, the CD player may not work normally if its internal parts have become too hot. In this case, wait until the CD player cools down before using it.
- Just after turning on the heater or when the cab is very humid, condensation may form inside the audio system and cause the CD player to malfunction.

If this happens, remove the CD and leave the player as it is with the power turned on for several minutes to let the condensation evaporate.

1.1 Tips on using CDs

- CDs not having the  or  mark cannot be played using this player. CD-R/RW may not play using this player.
- Specially shaped CDs, such as square or octagonal CDs, cannot be played using this player. Only use round CDs.
- Store CDs in their cases. Do not expose them to direct sunlight, and do not keep them in a humid or hot place.
- Fingerprints on the shiny side (non-label side) of the CD can impair sound reproduction. Always hold the CD between two fingers, one in the center hole and the other on the outer edge.
- Use a soft cloth to remove dirt from CDs. Wipe them in straight lines from the center toward the outer edge. Never use thinner or antistatic fluid to clean a CD.
- Do not use cracked or evidently warped CDs. Also avoid using CDs with a printable label surface. Using these type of CDs may cause the player to malfunction.

- Do not mark CDs with a ballpoint pen or anything else. Also do not stick paper or a label on the surface of CDs.
- New CDs may have rough inner and/or outer edges (formed by excess material during production). CDs with rough edges may not be inserted into the player or may cause the reproduced sound to skip. If you find any roughness on the edges of a new CD, remove it using a ballpoint pen or other appropriate object before inserting it into the player.

1.2 Discs, USB devices and files

The audio system on your vehicle can play music CDs (CD-R and CD-RW), MP3/WMA file CDs (CD-R and CD-RW) and USB devices.

• Discs

If the disc is a CD-R or CD-RW, the player cannot play it if the recording technology used to write data to the disc and its physical format are inappropriate for the system.

The following discs cannot be played by this system.

- Warped, damaged or soiled discs
- Discs with corrupted data

• USB devices

The system can play USB memories and other USB devices compatible with the USB Mass Storage Class. Note that the system does not support iPod and iPhone.

NOTE:

- *To find whether your USB device is compatible with the USB Mass Storage Class, ask the dealer of the USB device.*
- *Always make a backup of important data in case stored data is lost.*
- *To use an iPod or iPhone, connect it to the AUX input terminal.*
- *iPod and iPhone are trademarks of Apple Inc. in the United States and other countries.*

- **MP3/WMA files**
- MP3 (MPEG Audio Layer III) is a standard coding format for digital audio data compression.
- WMA (Windows Media[®] Audio) is the coding format for digital audio data compression developed by Microsoft Corporation.

NOTE:

Windows[®] is a registered trademark of Microsoft Corporation in the United States and other countries.

Windows Media[®] is either a registered trademark or trademark of Microsoft Corporation in the United States and other countries.

- The system cannot reproduce the following files:
 - MP3 files in an inappropriate format
 - WMA files with validated digital rights management (DRM)
 - Other audio files such as WAVE
- If a CD concurrently contains music CD (CD-DA) data and MP3/WMA files, only the data that is first detected is played. Also, these types of CDs may play abnormally or make no sound at all.

2 Using the AM/FM radio and the CD player

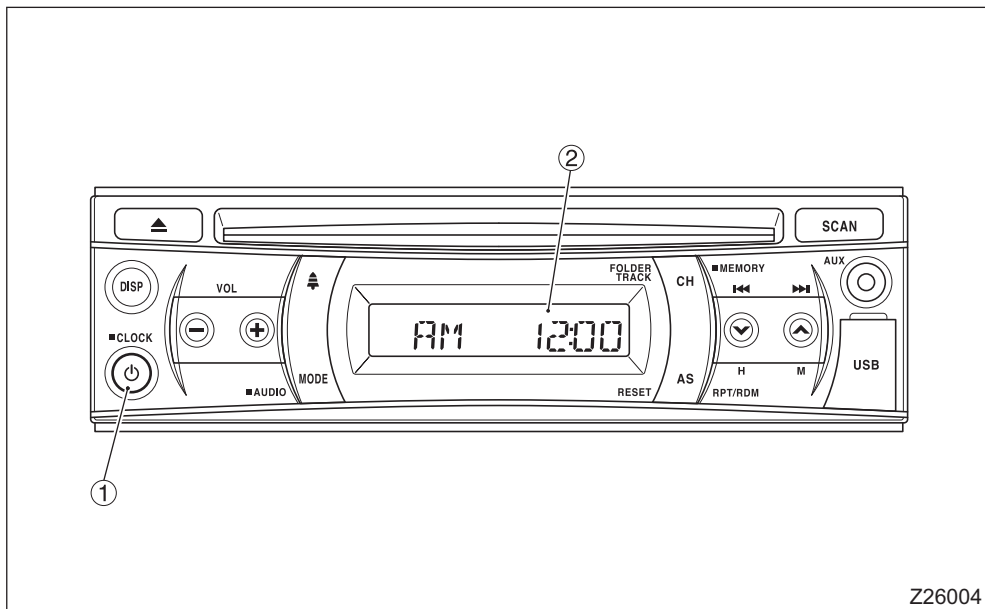

Z26004

① Power button

② Display

To use the AM/FM radio and the CD player, turn the power on.

With the starter switch in the "ACC" or "ON" position, press the power button to turn on the power.

The display will show the mode previously used and then, about 5 seconds later, show the time.

To turn off the power, press the button again.

3 Adjusting the volume and tone

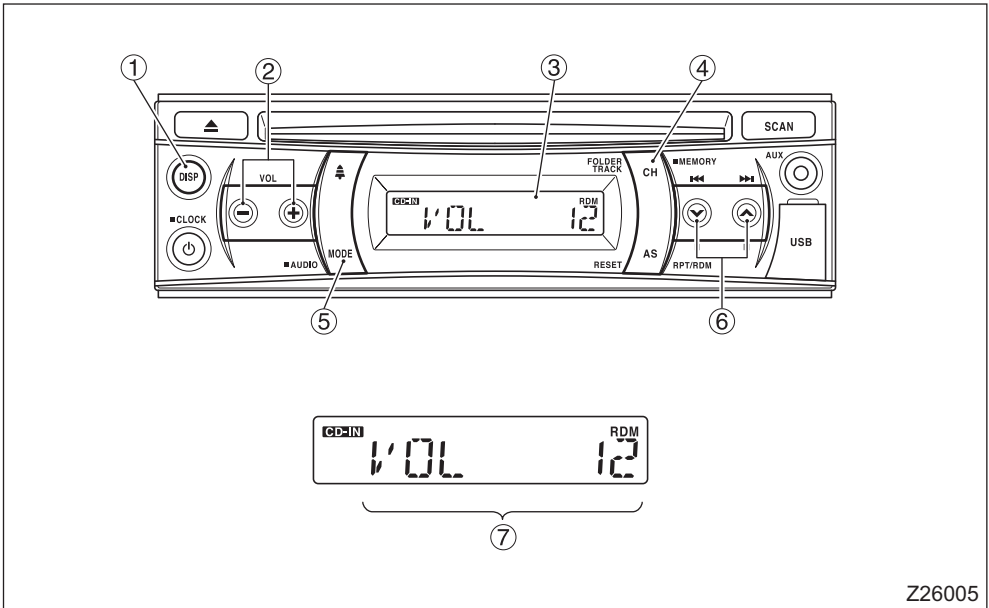

Z26005

- ① “DISP” button
- ② Volume buttons
- ③ Display
- ④ “CH” button
- ⑤ “AUDIO” button
- ⑥ ▲ and ▼ tuning buttons
- ⑦ Volume/adjustment mode display

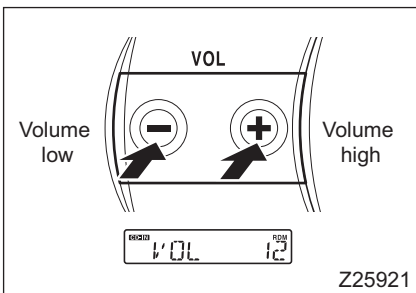

Z25921

3.1 Adjusting the volume

- Use the volume buttons to adjust the volume.
- Press the + button to increase the volume, or press the – button to reduce it.
- Press and hold the + or – button to change the volume continuously.
- The volume is adjustable from levels 0 to 30.
 - The display shows the selected volume level.

Example: Volume level 12

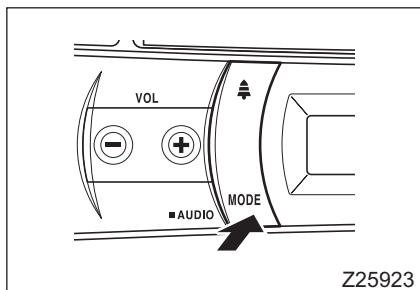
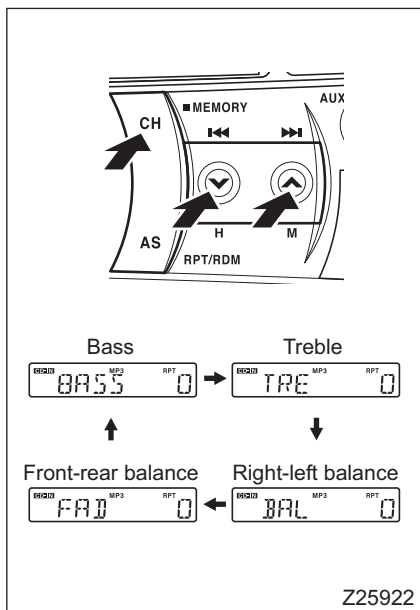

3.2 Adjusting the tone and balance

Press the “AUDIO” button, “CH” button, and \wedge or \vee tuning button to adjust the tone, front-rear volume balance and left-right volume balance.

1. Press the “AUDIO” button for 2 seconds or longer to enter the audio adjustment mode.
2. Press the “CH” button to select the desired adjustment mode.
 - Each time the “CH” button is pressed, the adjustment mode will change as follows:
 “BASS” (bass) → “TRE” (treble) → “BAL” (balance) → “FAD” (fader)

If you perform no operation in the 5-second period after selecting a mode, the adjustment mode cancels automatically.
3. In the desired mode, use the \wedge and \vee tuning buttons to make adjustments.

• **Function display**

Adjustment mode	Mode display	Adjustable range	Description
Bass tone adjustment (BASS)	BASS	-7 to +7	The display shows "BASS". If the displayed number has a minus sign, bass tone is de-emphasized as the number increases, and it is emphasized if the number has a plus sign.
Treble tone adjustment (TREBLE)	TRE	-7 to +7	The display shows "TRE". If the displayed number has a minus sign, treble tone is de-emphasized as the number increases, and it is emphasized if the number has a plus sign.
Balance adjustment (BALANCE)	BAL	R8 to L8	The display shows "BAL". If the display shows "BAL L", the volume of the left speaker increases as the number increases. If the display shows "BAL R", the volume of the right speaker increases as the number increases.
Fader adjustment (FADER)	FAD	R8 to F8	The display shows "FAD". If the display shows "FAD F", the volume of the front speaker increases as the number increases. If the display shows "FAD R", the volume of the rear speaker increases as the number increases.

NOTE:

If the audio system has no rear speakers connected, selecting an increased "FADER" number in the fader adjustment mode will gradually lower the overall volume. Select the neutral adjustment or an appropriate "FADER" number instead.

3.3 Switching the speaker output

Press the "AUDIO" button while pressing the "DISP" button to switch between the front speaker output and the front speaker + rear speaker output.

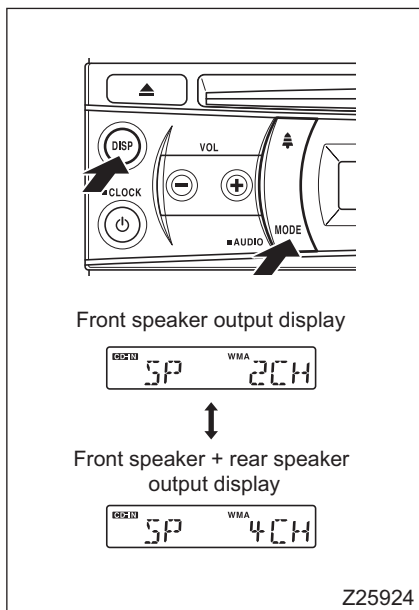

NOTE:

When you select the front speaker output, the fader adjustment function (FADER) is disabled.

4 Listening to the radio

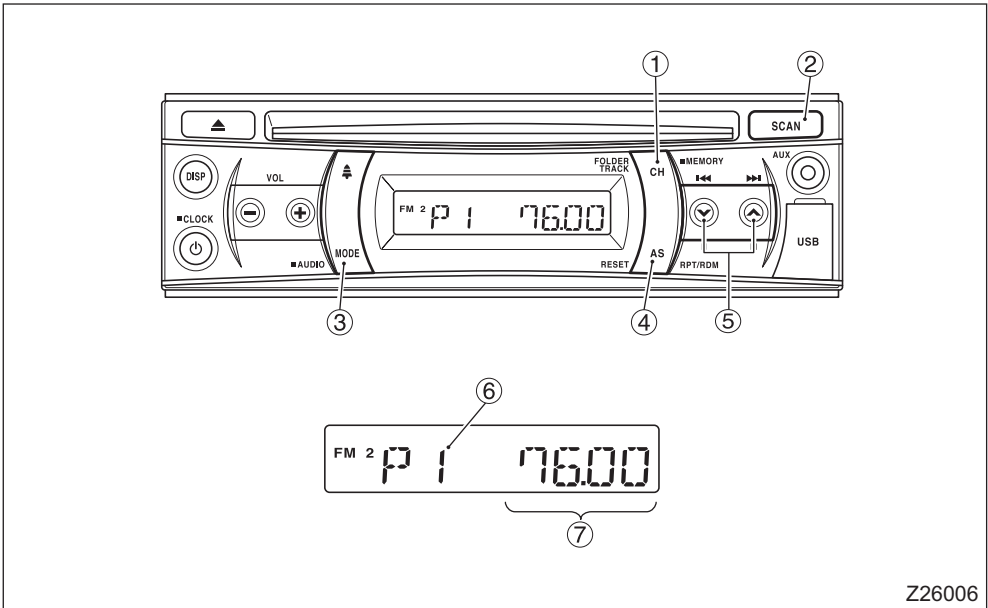

Z26006

- | | |
|----------------------------------|---|
| ① Preset buttons | ⑤ ▲ and ▼ tuning buttons |
| ② SCAN button | ⑥ Preset button number |
| ③ "MODE" button | ⑦ Reception band/frequency display and time display |
| ④ Automatic tuning/memory button | |

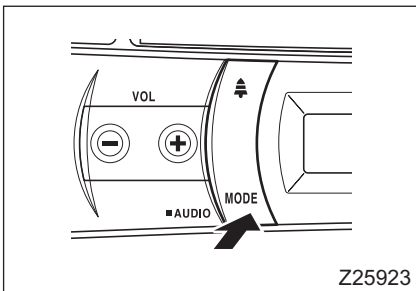

Z25923

4.1 Using the radio

Tune to the desired station.

- Press the "MODE" button.
Each time the button is pressed, the mode changes as follows:
AM → FM1 → FM2 → CD → USB → AUX

When no disc is in the player, the mode will not change to the CD mode. When no USB device is connected to the audio system, the mode will not change to the USB mode.

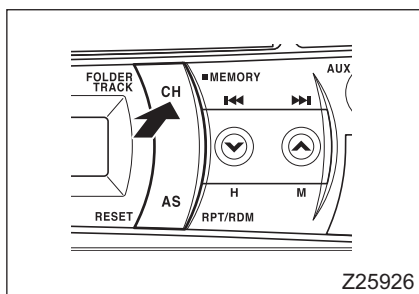

- Tuning to a preset station
Press the “CH” button.
- Tuning to a non-preset station
Press the \wedge or \vee tuning button.

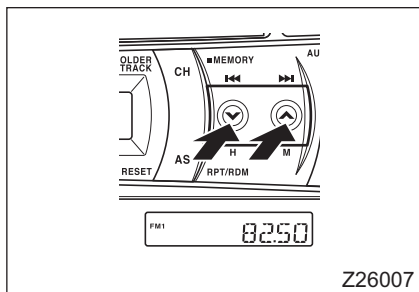

4.2 Manual tuning

Press the \wedge or \vee tuning button.

\wedge : Press this button for higher frequencies.

\vee : Press this button for lower frequencies.

4.3 Automatic tuning

Press the \wedge or \vee button for 0.5 seconds or longer. After a short beep, the radio starts automatic tuning. It will then stay tuned to the first station with good reception.

\wedge : Press this button for higher frequencies.

\vee : Press this button for lower frequencies.

NOTE:

Use manual tuning if you cannot tune to a desired station by automatic tuning due to poor signal reception.

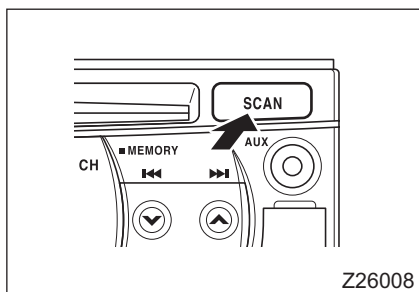

4.4 Automatic tuning using the “SCAN” button

- Press the “SCAN” button. The radio will automatically tune in to higher frequencies.
- When the radio tunes in a station, the frequency indication flashes on the display. The radio stays tuned in to the station for 5 seconds before restarting scan searching for the next receivable station.
- Press the “SCAN” button again to stop the scan searching.

If you press the “SCAN” button while the radio is still searching for a station, the radio will tune in to the previous received station.

4.5 Programming stations to channels

• **Manual programming**

1. Select the desired band from FM1, FM2, and AM using the "MODE" button.

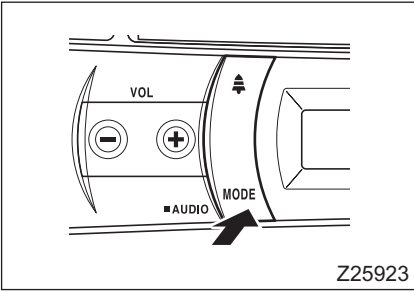

2. Make the frequency of your desired station appear on the display using the \wedge or \vee tuning button.

\wedge : Press this button for higher frequencies.

\vee : Press this button for lower frequencies.

If you press the \wedge or \vee tuning button for 0.5 seconds or longer, the radio starts automatic tuning after a short beep and will then stay tuned to the first station with good reception.

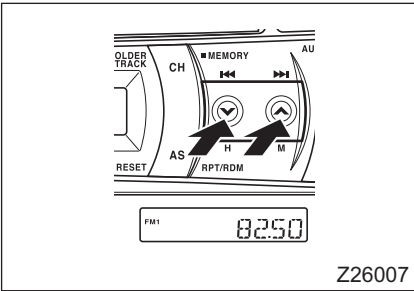

NOTE:

Use manual tuning if you cannot tune to a desired station by automatic tuning due to poor signal reception.

3. Press and hold the "CH" button to enter the programming mode.

4. Press the "CH" button to select the desired preset station number.

5. Press and hold the "CH" button.

A short beep will sound indicating that the selected station has been programmed to the button.

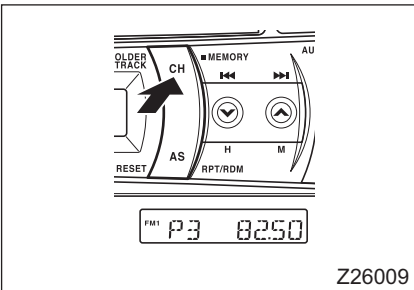

NOTE:

- If you program a new station to a preset station number to which another station has already been programmed, the previously programmed station will be automatically erased.
- If the battery is disconnected or the relevant fuse is removed, all stations programmed to the preset channels are erased from memory. In that case, program stations again.

- **Automatic programming**

1. Select the desired band from FM1, FM2, and AM using the "MODE" button.
2. Press and hold the "AS" button.
After a short beep, automatic tuning will start. Each time the radio tunes to a station with good reception, the station is automatically programmed to a preset station number. The lowest frequency station is programmed to number "1" and the highest frequency station is programmed to number "6".

NOTE:

If the signal reception is too poor to receive 6 stations, then only the stations received are programmed. If no station can be received, the mode returns to the original mode without programming any station.

5 Listening to a CD using the CD player

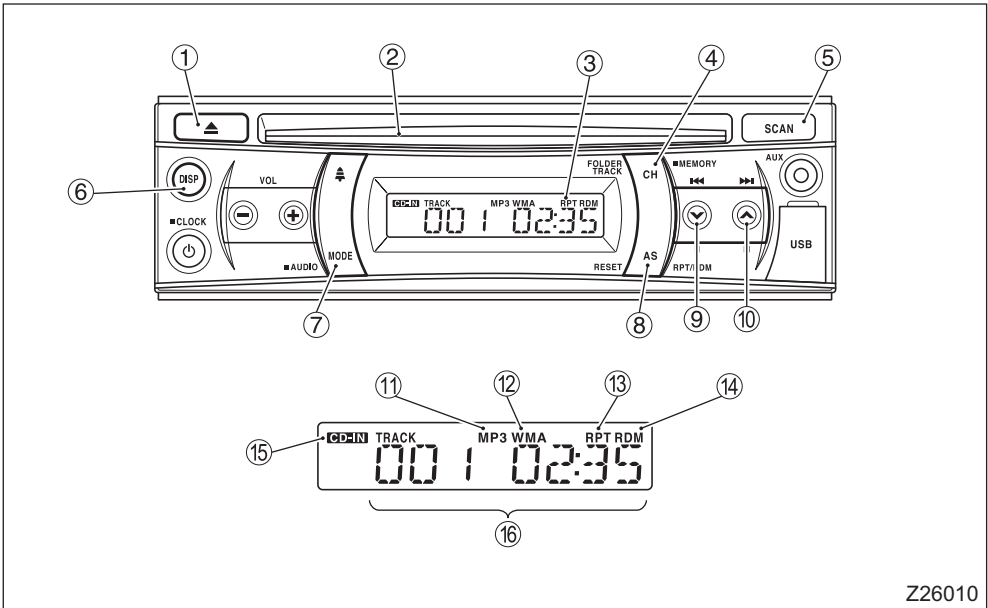

Z26010

- | | |
|--|---|
| <ul style="list-style-type: none"> ① Disc eject button ② Disc slot ③ Display ④ Folder/tracks button (MP3/WMA) ⑤ SCAN button ⑥ "DISP" button (display selector) ⑦ "MODE" button ⑧ Repeat/random play button ⑨ Downward track select button / downward folder select button (MP3/WMA)/rewind button | <ul style="list-style-type: none"> ⑩ Upward track select button / upward folder select button (MP3/WMA)/fast forward button ⑪ MP3 display ⑫ WMA display ⑬ RPT display ⑭ RDM display ⑮ "CD-IN" display ⑯ Music information and time display |
|--|---|

- With the starter switch in the "ACC" or "ON" position, press the power button or the "MODE" button, or insert a CD into the disc slot to turn on the power.
- Inserting a CD into the disc slot will switch the audio system to the CD player mode even while you are listening to the radio or USB device.

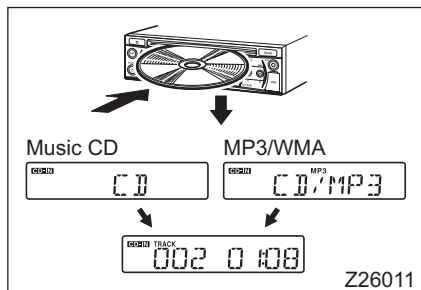

5.1 Playing a CD

1. Insert a CD into the disc slot with the labeled surface facing up.
2. The CD player will automatically turn on and start playback.
 - When using a music CD, the display shows "CD" for 2 seconds, and then shows the track number and the playing time. After that, the display switches to the time display.
 - When using an MP3 or WMA file CD, the display shows "CD/MP3" for 2 seconds, and then shows the track number and the playing time. After that, the display switches to the time display.

! CAUTION

Do not try to play an 8 cm (3-inch) CD with this system. Do not use adapters because they may damage the CD player.

NOTE:

- A "CD-IN" message is displayed when a CD is already inside the player.
- After inserting a CD, the player takes a little time to read data before starting playback. It will usually take longer for a CD-RW than for other types of CDs.

5.2 Switching to the CD mode while listening to the radio

If you press the "MODE" button to switch to the CD mode while a CD is inside the player, playback will start from the track segment just after the one at which the previous playback stopped.

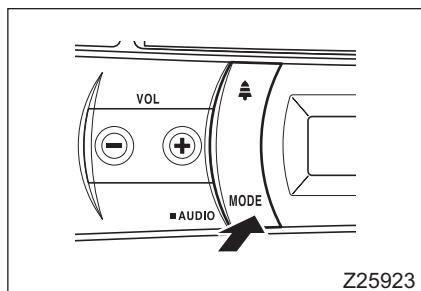

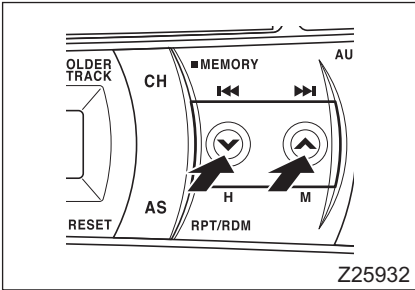

5.3 Basic operations

Fast forwarding/rewinding

- Press and hold the \wedge or \vee tuning button. Fast forwarding or rewinding of the disc continues until the button is released.
 - \wedge : Press this button for fast forwarding.
 - \vee : Press this button for rewinding.
- Playback starts as soon as you release the button.

Cueing

Press the \wedge or \vee tuning button until the display indicates the desired track number.

- \wedge : Press this button for a higher track number.
- \vee : Press this button for a lower track number.

Folder cueing (MP3/WMA)

1. Press the “CH” button to switch to the folder selection mode.
2. Press the \wedge or \vee tuning button until the display indicates the desired folder.
 - \wedge : Press this button once for the next folder.
 - \vee : Press this button once for the previous folder.
3. Press the “CH” button again to go back to the track selection mode.

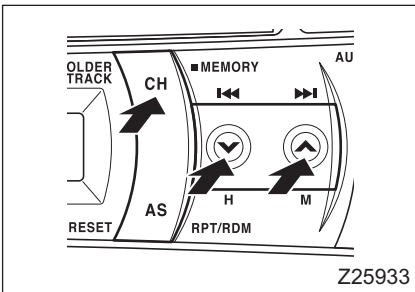

5.4 Repeating the same track

- Press the “RPT/RDM” button.
- The display will show “RPT”. (Playback of the next track will be repeated if you press the button between two tracks.)
- To cancel the repeat playback mode, press the “RPT/RDM” button twice.

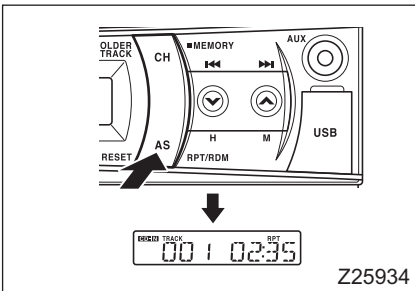

5.5 Playing the tracks in random order

- Press the “RPT/RDM” button twice. The tracks are played in an order different from the disc.
- The display will show “RDM”.
- Press the same button again to cancel.

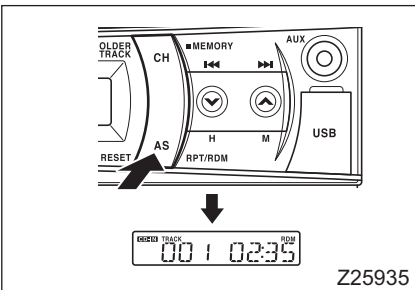

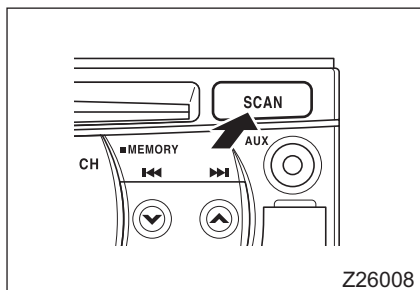

5.6 Scan search playback

The player reproduces the first 10-second part of each track.

This function is useful for finding your favorite tracks.

1. Press the “SCAN” button.
2. The player will reproduce the first part of the next tracks one after another for 10 seconds each.
3. Press the button again to cancel the scan search playback.

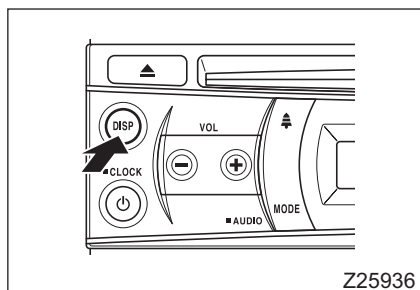

5.7 Switching the display during playback (MP3/WMA)

- Each time the “DISP” button is pressed, the display changes as follows: Track number and playing time → Folder number and playing time → File name → Folder name → Title TAG → Album TAG → Artist TAG → Time display.
- If you select a display other than the time display and perform no operation, the display goes back to the time display after 5 seconds.

NOTE:

“NO TAG” is displayed if the relevant tag contains no entries.

5.8 Ejecting a CD







- If you press the “EJECT” button, the player stops playback and ejects the disc.
- As soon as you remove the CD, the radio starts receiving the station you last listened to.

NOTE:

To protect the disc from dust or dirt, the disc is drawn back inside the player automatically if it is left in the ejected state for 10 seconds.

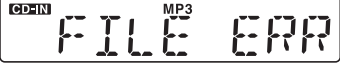
5.9 Error display while playing a CD

The following table lists possible causes for ERR display.

Display	Cause	Action
	The disc is stuck in the player and cannot be ejected.	Contact an authorized dealer.
	<ul style="list-style-type: none"> • The disc was inserted upside down. • The disc inserted is not a music disc. • The disc cannot be read because of scratches, dirt, warping, or other abnormalities. 	<ul style="list-style-type: none"> • Insert the disc correctly. • Insert a music disc. • Check the disc for any abnormality.
	Inappropriate data written to CD.	Check that the data format is appropriate.
	The disc contains WMA files with validated digital rights management (DRM).	
	The pickup lens inside the player is soiled or has reached the end of its service life.	<ul style="list-style-type: none"> • Clean the pickup lens. • Contact an authorized dealer if the condition does not improve.
	The temperature inside the player is high.	Eject the disc and wait until the internal temperature goes down.

6 Playing audio files in a USB device

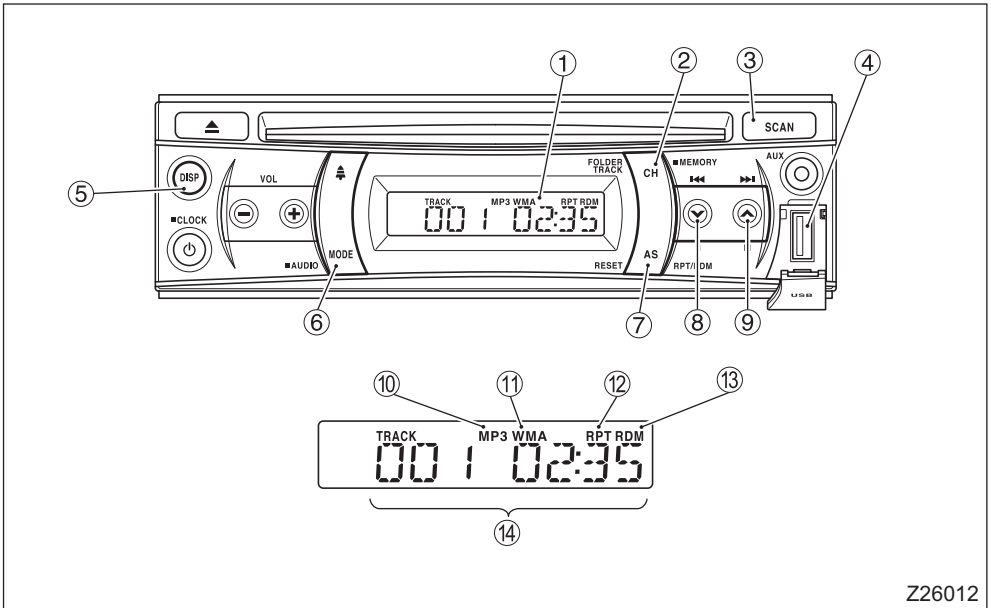

Z26012

- | | |
|--|--|
| ① Display | ⑨ Upward track select button/
upward folder select button/
fast forward button |
| ② Folder/track button (MP3/WMA) | |
| ③ SCAN button | |
| ④ USB port | |
| ⑤ "DISP" button (display selector button) | ⑩ MP3 display |
| ⑥ "MODE" button | ⑪ WMA display |
| ⑦ Repeat/random play button | ⑫ RPT display |
| ⑧ Downward track select button/
downward folder select button/
rewind button | ⑬ RDM display |
| | ⑭ Music information and time display |

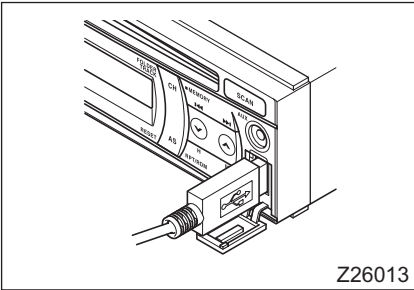

6.1 Playing audio files in a USB device

1. Open the USB port cover.
2. Connect a USB extension cable to the USB port.

CAUTION

A USB device becomes a protruding object when connected directly to the port, and could pose danger during driving. Always use a commercial USB extension cable.

3. Connect a USB extension cable to the USB device.
4. Press the "MODE" button to change to the USB mode, then playback will start automatically.

NOTE:

- *Insert the USB device completely into the connector. If it is inserted half way, the USB device may not be recognized.*
- *It could take some time to read the audio files depending on the number of files stored in the USB device.*

6.2 Switching to the USB mode while listening to the radio

If you press the "MODE" button to switch to the USB mode while a USB device is connected, playback will start from the track segment just after the one at which the previous playback stopped.

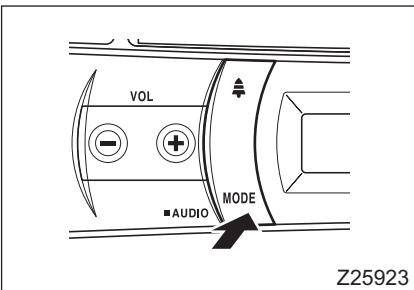

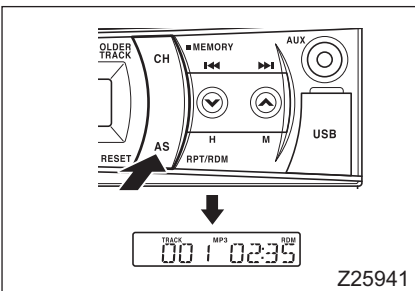
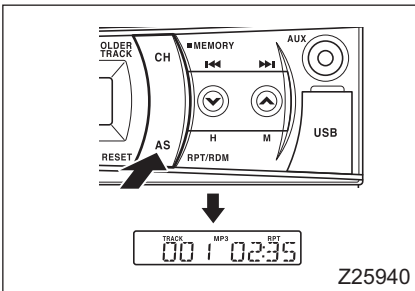
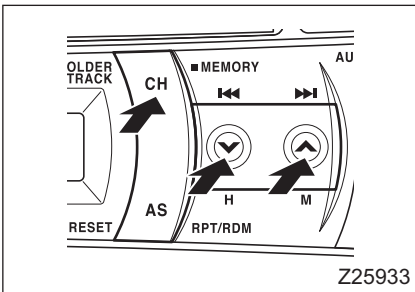
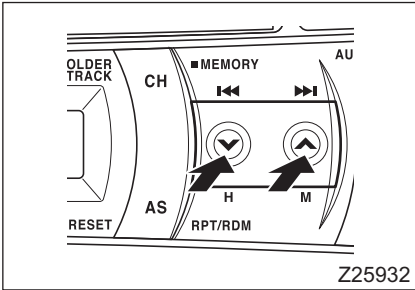

6.3 Basic operations

Fast forwarding/rewinding

- Press and hold the \wedge or \vee tuning button. Fast forwarding or rewinding of the music continues until the button is released.

\wedge : Press this button for fast forwarding.

\vee : Press this button for rewinding.

- Playback starts as soon as you release the button.

Cueing

Press the \wedge or \vee tuning button until the display indicates the desired track number.

\wedge : Press this button for a higher track number.

\vee : Press this button for a lower track number.

Cueing folders

- Press the “CH” button to switch to the folder selection mode.
- Press the \wedge or \vee tuning button until the display indicates the desired folder.
 - \wedge : Press this button once for the next folder.
 - \vee : Press this button once for the previous folder.
- Press the “CH” button again to go back to the track selection mode.

6.4 Repeating the same track

- Press the “RPT/RDM” button.
- The display will show “RPT”. (Playback of the next track will be repeated if you press the button between two tracks.)
- To cancel the repeat playback mode, press the “RPT/RDM” button twice.

6.5 Playing music in a folder in random order

- Press the “RPT/RDM” button twice. The tracks in the folder are played in an order different from the folder.
- The display will show “RDM”.
- Press the same button again to cancel.

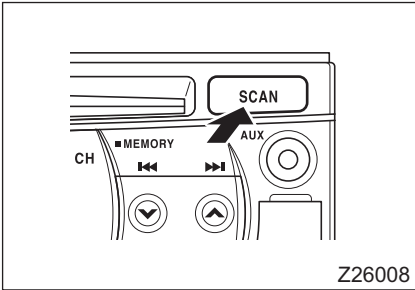

6.6 Scan search playback

The player reproduces the first 10-second part of each track.

This function is useful for finding your favorite tracks.

1. Press the “SCAN” button.
2. The player will reproduce the first part of the next tracks one after another for 10 seconds each.
3. Press the button again to cancel the scan search playback.

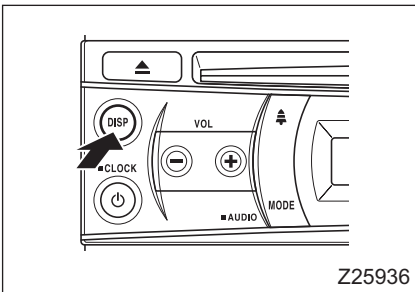

6.7 Switching the display during playback

- Each time the “DISP” button is pressed, the display changes as follows: Track number and playing time → Folder number and playing time → File name → Folder name → Title TAG → Album TAG → Artist TAG → Time display.
- If you select a display other than the time display and perform no operation, the display goes back to the time display after 5 seconds.

NOTE:

“NO TAG” is displayed if the relevant tag contains no entries.

6.8 Removing the USB device





1. Press the “MODE” button to select a mode other than the USB mode.
2. Remove the USB extension cable from the USB port.
3. Close the USB port cover.

CAUTION

- **When removing the USB device, make sure that the USB device is not being accessed. If the USB device is removed in the following cases, data could be damaged.**
 - Removing the USB device or turning off the power of the audio system while an audio file in the USB device is being read.
 - Subjecting the USB device to static electricity or electrical noise.
- Do not leave any USB device inside the vehicle. Direct sunlight or high temperature could deform or break the USB device.

6.9 Error display while playing audio files in a USB device

The following table lists possible causes for ERR display.

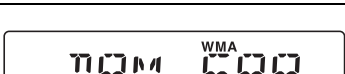
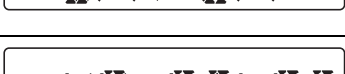
Display	Cause	Action
	A hub device is connected to the USB port.	The audio system does not support hub device.
	An incompatible USB is connected.	Remove the USB and connect a compatible USB.
	Audio files cannot be read due to USB abnormality.	Check the USB for any abnormality.
	Inappropriate data written to the USB.	Check that the data format is appropriate.
	The USB contains WMA files with validated digital rights management (DRM).	
	There are no MP3/WMA files.	

7 Using the AUX input

You can listen to music by connecting a commercial portable audio system to the AUX input terminal.

- Press the “MODE” button to select the AUX mode.
- Use a commercial 3.5 mm stereo mini plug cord to connect to the AUX input.

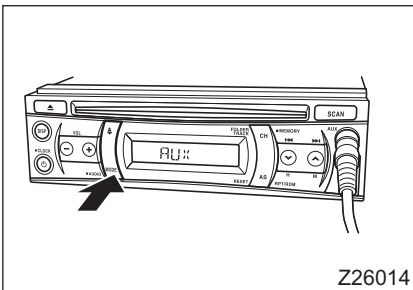

8 Clock

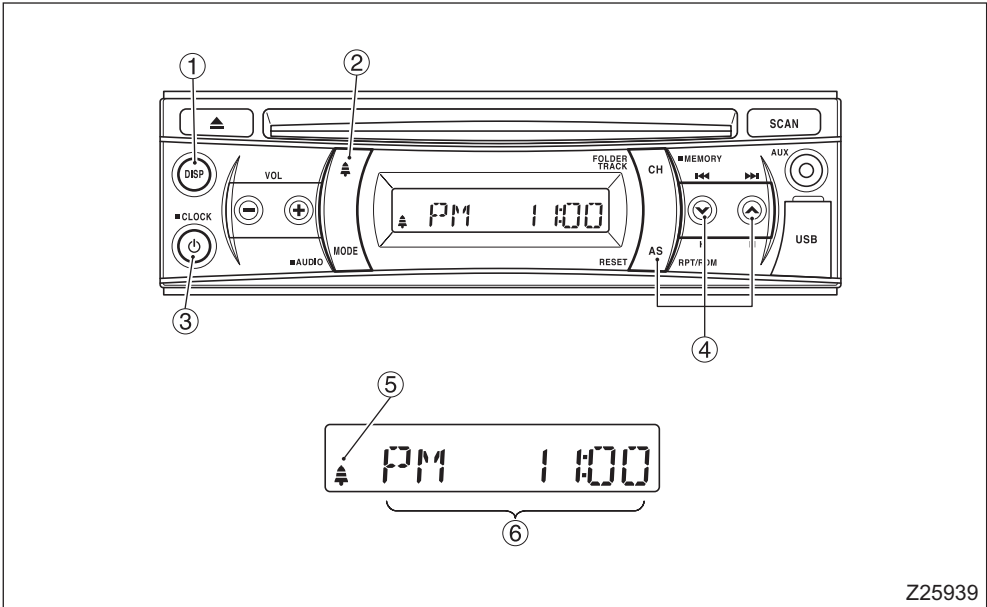

Z25939

- | | |
|---|---------------------------|
| ① "DISP" button (display selector button) | ④ Time adjustment buttons |
| ② Alarm button | ⑤ Alarm symbol |
| ③ Power button | ⑥ Time display |

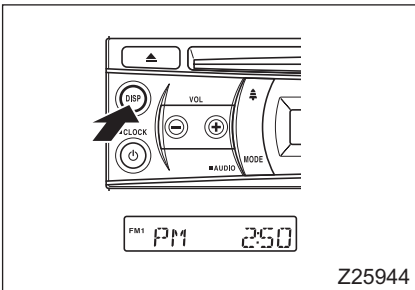

Z25944

8.1 Switching the display

- While listening to the radio, each press of the "DISP" button switches the display in the following order: Time display → Frequency display.
- While listening to a music CD, each press of the "DISP" button switches the display in the following order: Time display → Track number and playing time.
- While listening to MP3/WMA, each press of the "DISP" button switches the display in the following order: Time display → Track number and playing time → Folder number and playing time → File name → Folder name → Title TAG → Album TAG → Artist TAG.
- The display goes back to time display after about 5 seconds.

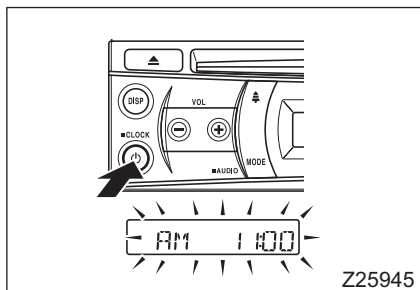

8.2 Setting the clock

1. Press and hold the power button while the display is showing the time of day. A short beep will sound, and the time display will start flashing.

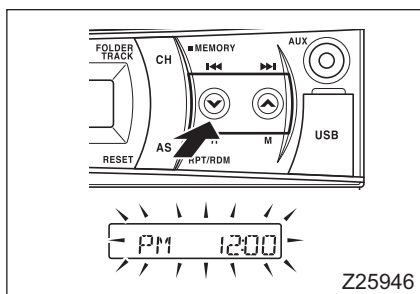

2. Press the ∇ tuning button to set the hour. Each press of the button advances the hour by 1. Pressing and holding the button will advance the hour continuously.

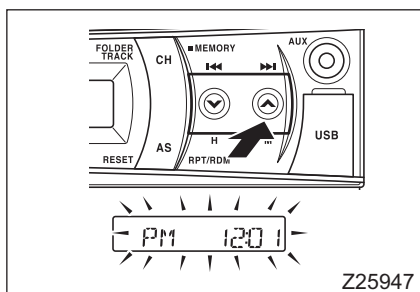

3. Press the \blacktriangle tuning button to set the minutes. Each press of the button advances the minutes by 1. Pressing and holding the button will advance the minutes continuously.
4. Press and hold the power button for 1 second or longer when setting of the clock is complete. If you press the button for less than 1 second, then the audio system power will be turned off together with the completion of the clock setting.

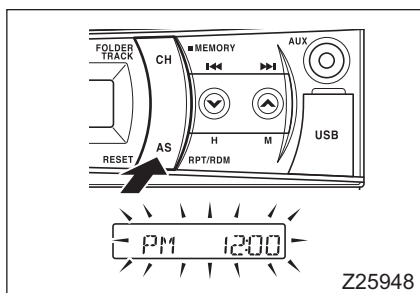

8.3 Setting the clock by the time signal

1. In the time adjustment mode, press the "AS" button at the same time as a time signal. If the minutes are less than 30, it is rounded down and if the minutes are larger than 30, it is rounded up.
Example: 12:00 to 12:29 is rounded down to 12:00, and 12:30 to 12:59 is rounded up to 1:00.
2. Press and hold the power button for 1 second or longer.
If you press the button for less than 1 second, then the audio system power will be turned off together with the completion of the clock setting.

9 Using the alarm

If you set the alarm to the desired time, a buzzer will sound at the preset time.

NOTE:

The alarm time setting is canceled if the battery is disconnected or the relevant fuse is removed. You will then need to set the alarm time again.

9.1 Setting the alarm time

1. Press the  button (less than 2 seconds) to switch to the alarm time display. When about 5 seconds elapses after displaying the alarm time, the display will go back to the time display.

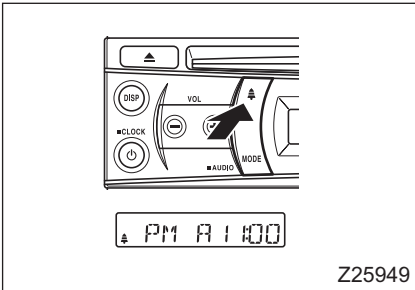

2. With the alarm time appearing on the display, press and hold the power button. A short beep will sound, and the time display will start flashing.

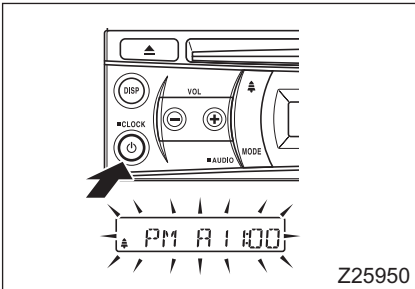

3. Press the  button to set the hour. Each press of the button advances the hour by 1. Pressing and holding the button will advance the hour continuously.

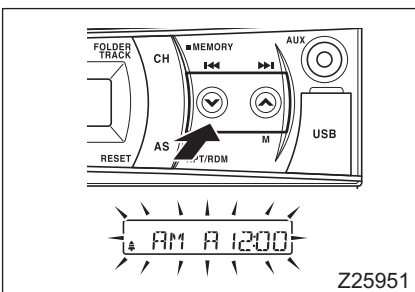

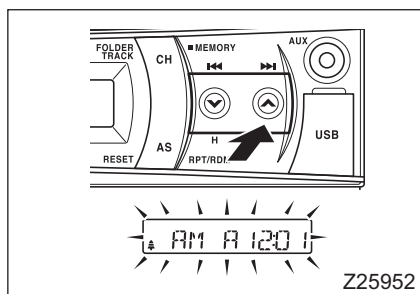

4. Press the \wedge tuning button to set the minutes. Each press of the button advances the minutes by 1. Pressing and holding the button will advance the minutes continuously.
5. Press and hold the power button for 1 second or longer. If you press the button less than 1 second, then the audio system will be turned on or off together with the completion of the alarm setting.

NOTE:

You can set the alarm even when the starter switch is in the "LOCK" or "ACC" position. In that case, however, you will hear no short beep.

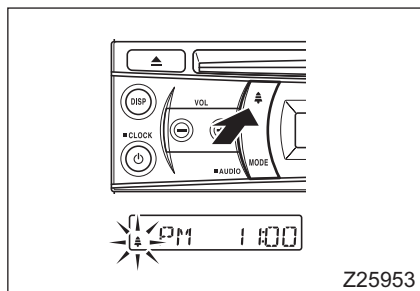

9.2 Activating the alarm

- Press and holding the \wedge button activates the alarm, and press and holding the button again deactivates the alarm. A short beep sounds every time the alarm is activated or deactivated.
- The \wedge mark appears when the alarm is activated, and it disappears when the alarm is deactivated.
- The alarm buzzer sounds even during radio reception or CD playback, the beep being superimposed on the radio or CD sound.
- The alarm sounds at the preset time and the beep lasts 3 minutes. To stop the beep, press any button other than the power button. You can stop the alarm by pressing the power button, but in that case the audio system turns on or off at the same time.

NOTE:

- You can activate or deactivate the alarm by press and holding the "ALARM" button even when the starter switch is in the "LOCK" or "ACC" position. In that case, however, you will hear no short beep.
- The alarm is triggered regardless of the starter switch position. We recommend deactivating the alarm when not using it.

ACCESSORIES

- See an authorized dealer if you are considering adding accessories to your vehicle.
- Your vehicle contains electronic devices. Even though these are protected against interference from electromagnetic emissions, you should refer to an authorized dealer before fitting equipment that emits strong signals, such as mobile telephones.



WARNING

To avoid the risk of overheating/fire or faulty operation, have electrical accessories connected by an authorized dealer. Never connect them yourself.

11. COLD WEATHER CARE AND INFORMATION

COOLANT	11-2
ENGINE OIL	11-2
FUELS	11-2
WHEN PARKING THE VEHICLE AFTER REPLENISHING THE DEF (DIESEL EXHAUST FLUID)	11-3
OTHER RECOMMENDATIONS FOR COLD WEATHER OPERATION	11-4
INSTALLING TIRE CHAINS	11-6

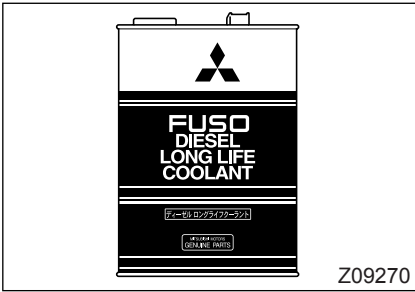

COOLANT

- When vehicles are shipped from the factory, genuine FUSO DIESEL LONG LIFE COOLANT is added to the coolant in their cooling systems. This additive combines both antifreeze and anti-rust capabilities to sufficiently protect the cooling system from freezing up. However, for added safety, it is recommended that you have an authorized dealer check that the coolant has a proper concentration of the additive before winter begins.
- Be sure to use coolant added with the FUSO DIESEL LONG LIFE COOLANT or equivalent to the recommended concentration. ⇒ P. 12-57

CAUTION

Never mix FUSO DIESEL LONG LIFE COOLANT with other brands of anti-freeze or anti-corrosion additives since these can detract from its performance. If a different coolant additive has been used and the FUSO DIESEL LONG LIFE COOLANT is to be used, be sure to thoroughly flush the cooling system.

ENGINE OIL

The viscosity of the engine oil increases in cold temperatures, sometimes making it hard to start the engine, especially early in the morning. Therefore, use an engine oil of a viscosity which suits the weather conditions. ⇒ P. 12-22

FUELS

Ordinary diesel fuel gels in freezing temperatures, making it impossible to start the engine. If you are bound for a cold area, it is recommended that you fuel your vehicle so that it burns more than half the fuel by the time you reach your destination. This allows you to refuel with a grade of diesel fuel appropriate to the colder weather conditions.

⇒ P. 1-5

**WHEN PARKING THE VEHICLE
AFTER REPLENISHING THE DEF
(DIESEL EXHAUST FLUID)**

The driving restriction is engaged when the DEF tank becomes empty. After refilling with DEF in cold weather, parking without canceling the driving restriction will cause the DEF to freeze, and the driving restriction cannot be canceled until the DEF thaws. In cold weather, cancel the driving restriction immediately after refilling with DEF. ⇒  P. 1-11

NOTE:

The freezing point of DEF is approximately -11 °C (12 °F).

**OTHER RECOMMENDATIONS FOR
COLD WEATHER OPERATION**

- If the engine fails to start, turn the starter switch back to the “ACC” position or “LOCK” position and wait for the battery to recover before trying to start the engine again.
- As the temperature falls, battery performance decreases. Check the battery electrolyte level and its specific gravity. ⇒  P. 12-90
- Special lubricants must be used if the vehicle is used at temperatures below -25°C (-13°F). For details, refer to an authorized dealer.
- In cold weather, use a windshield washer fluid additive in the concentration indicated by the manufacturer’s instructions.

**CAUTION**

Do not use engine coolant or antifreeze in place of windshield washer fluid since these products will damage the vehicle’s paint.

- Occasionally check the undercarriage and fender wells, and if necessary remove snow and ice taking care not to damage vehicle parts as you do so. There is ABS equipment, electrical wiring, and so on, on the inside of the tires, so be careful not to damage them when removing snow and ice from the tires.
- Remove any snow or ice on the headlamps, other lamps, and the license plate.
- Remove snow or ice, if there is any, from the air conditioner condenser behind the bumper. Using the air conditioner with snow or ice on the condenser will damage the air conditioner or cause a drop in performance.
- The brakes may be frozen up when the vehicle is driven on snow-covered roads or during parking in cold weather. Since frozen brakes are sluggish to function, drive your vehicle carefully while paying attention to vehicles behind as well as in front and checking normal function of the brakes from time to time by slightly depressing the brake pedal. If the brakes are sluggish, depress the brake pedal repeatedly while driving at a low speed until normal braking returns.
- Avoid parking on a slope. Select a level, flat surface not directly exposed to wind or snow as far as possible. If there is wind, turn the front of the vehicle away from the wind.

- Do not apply the parking brake in extremely cold condition. This could cause the parking brake to freeze up and become impossible to release. In these conditions, take the following steps:
 1. Stop the vehicle and pull the parking brake lever. Never park on a slope.
 2. Place the gearshift lever in the “P” position.
 3. Block the wheels securely with chocks.
 4. Release the parking brake lever.
- Operate the air conditioner at least once a month to maintain its functions even during the cold season when it is not being used.

NOTE:

- *Forcing the door open if it is frozen could cause the rubber around the door to rip off or become cracked, so pour hot water over it before opening the door. Remember to wipe any water off afterwards.*
- *In a cold region, the lock cylinders and rubber parts of the door sometimes freeze, making it hard to open the door. After washing, remove moisture on and around the doors.*

INSTALLING TIRE CHAINS

- FG models: tire chains cannot be used on both front and rear wheels.
- FE models: install the tire chains on the driving wheels.
- Make sure that tire chains are installed properly so that they do not become loose and interfere with other vehicle parts while the vehicle is in motion.
- Use triple chains corresponding to tire size.



CAUTION

- **Do not use chains on the front wheels on FE models; instead, use of snow tires is recommended.**
- **If you use tire chains, be sure to install them without any slack.**
- **When fitting tire chains, refer to the instructions supplied with them.**
- **Drive at speeds lower than 30 km/h (19 mph) when chains are installed on wheels.**
- **Avoid driving the vehicle on a dry road with chains installed as this may damage the chains as well as the road surface.**
- **Confirm that the chains and their spring bands are not excessively worn or otherwise damaged.**
- **If you hear an abnormal noise while driving, stop the vehicle in the nearest safe place and check the tire chains.**

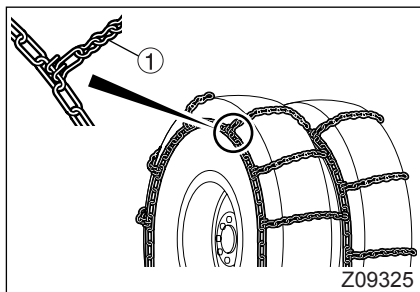

1. Place the chains over the tires with the hook ends of cross chains ① facing outward.

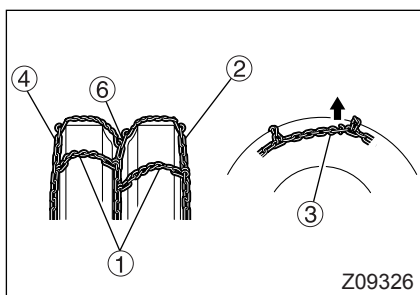

2. Connect the hook ③ of inside chain ②, leaving no excess links. Then, take up the slack in the inside chain by pulling cross chains ① for the inside tire outward.

NOTE:

Pull the hook section outward to the possible maximum extent.

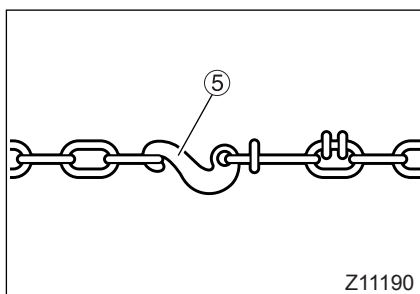

3. Temporarily connect hook ⑤ of outside chain ④ as shown.

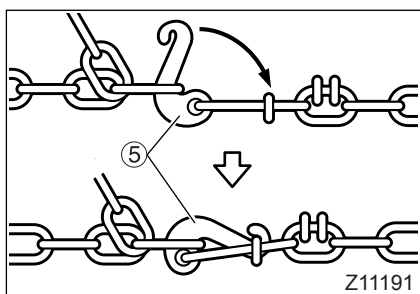

4. Pull the middle chain ⑥ as far as possible and connect its hook.
5. Pull both ends of outside chain ④ as far as possible and connect hook ⑤.

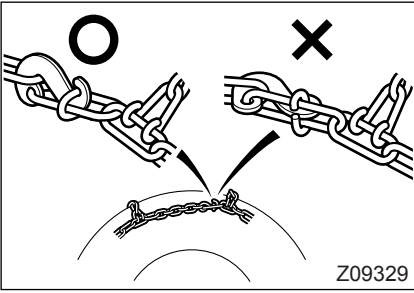

6. Ensure that hooks ③ and ⑤ are flat on the tire sidewalls. Also make sure that the chains are not twisted.
7. Fasten extra chain links with a metal wire to prevent them from hitting against other vehicle parts.

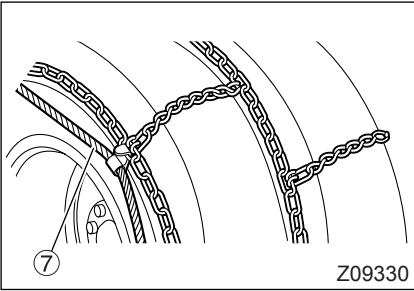

8. Fit spring band ⑦. Attach the hooks of spring band on the chain at even intervals with the hook ends facing outward.
9. After driving the vehicle for 5 to 10 minutes, check the chains for looseness or disconnected hooks.

12. SIMPLE INSPECTION AND SERVICE

GENERAL PRECAUTIONS WHEN SERVICING THE VEHICLE	12-2
TO REACH THE ACCESS OPENING	12-5
TILTING THE CAB	12-6
PRE-OPERATIONAL CHECKS	12-12
LUBRICATION	12-17
GREASING	12-18
OILS AND FLUIDS	12-22
FILTER ELEMENTS	12-41
DRAINING WATER FROM FUEL FILTER	12-56
ENGINE COOLANT – INSPECTION AND REPLACEMENT	12-57
V-BELTS – INSPECTION AND ADJUSTMENT	12-66
STEERING WHEEL – INSPECTION	12-68
SERVICE BRAKES – INSPECTION	12-69
PARKING BRAKE – INSPECTION AND ADJUSTMENT	12-71
TIRES – INSPECTION	12-72
TIRE REPLACEMENT	12-75
WHEELS AND WHEEL NUTS – INSPECTION AND RETIGHTENING	12-84
TIRE ROTATION	12-86
WIPER BLADE – REPLACEMENT	12-88
WINDSHIELD WASHER – FLUID LEVEL INSPECTION AND REFILLING	12-89
BATTERY – INSPECTION	12-90
AIR FILTERS – CLEANING	12-94
CLEANING YOUR VEHICLE	12-95
INTERCOOLER – CLEANING	12-101

GENERAL PRECAUTIONS WHEN SERVICING THE VEHICLE

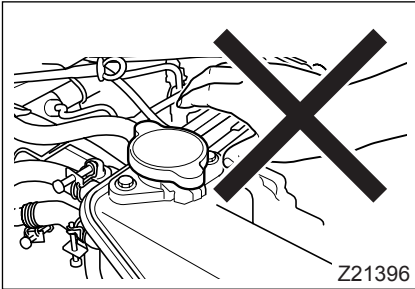
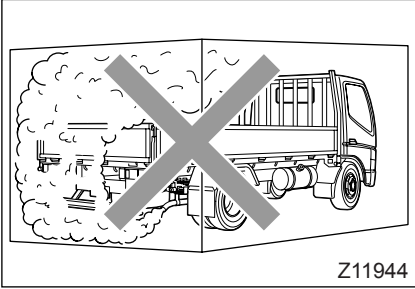

WARNING

- Never run the engine in a poorly ventilated area. Exhaust emissions contain carbon monoxide, which can cause unconsciousness or death when inhaled.
- Never smoke when servicing your vehicle since its fuel and the gases given off by its battery are highly flammable.
- When tilting the cab, carefully follow the instructions in this manual. Be sure to fit the stopper into the notch in the lock lever to prevent the cab from dropping. After letting the cab down, check that it is locked securely in position. (Vehicles other than Crew-cab models) ⇨  P. 12-8
- The engine gets extremely hot when running and stays hot for some time after being turned off. To avoid being burned, do not touch the engine, exhaust manifold, radiator, exhaust pipe, or other engine-related parts until they have cooled down.
- Do not loosen the engine pressure cap while the engine is hot. Wait for the engine to cool down, then grip the cap with a cloth and turn it slowly to release the internal pressure before removing it completely.
- Never crawl under the vehicle when it is supported only by a hydraulic jack since the jack could slip out of position and cause the vehicle to crush you.
- The battery cables and starter cables carry extremely high voltages. Be careful not to short-circuit them, e.g., with a tool, since this could cause serious injury.
- Take great care when working near the fan and fan belt. Never touch them when they are moving.
- Be careful not to hurt yourself on the corners of the body when performing inspections.
- Keep oily rags and other flammable items in a safe place.
- Put away all tools and rags after use. Items left in the engine bay could get hot and catch fire.

**WARNING**

- **Be sure to stop the engine before performing inspections with the cab tilted or engine access opening opened. If the engine was running and your hands, clothes, or other items touched or came into close proximity to the engine's rotating parts, they could be dragged into the mechanism, resulting in injuries. If you must unavoidably perform inspections with the engine running, do not on any account touch the fan or any other rotating part.**
- **The fuel injection system includes a high voltage circuit. You could receive an electric shock if inspections are performed with the starter switch in the "ON" position. If it is unavoidable to perform inspections with the starter switch turned "ON", be careful not to touch the electric wiring or connectors.**

Please take the following precautions when servicing your vehicle:

- Make sure the vehicle is on safe, level ground.
- Prevent the vehicle from moving by pulling the parking brake lever and blocking the wheels with chocks.
- Place the gearshift lever in the "P" position.
- Remove the starter key unless you need to run the engine.
- Take off wristwatches, rings, and neckties, and wear clothing that will not obstruct movement or snag on parts of the vehicle.
- Wear all safety gear necessary for your task, for example, hard hat or goggles.
- Use the correct tools for your task.
- Do not make adjustments or repairs unless you know exactly what you are doing. For servicing that is difficult or not shown in this manual, take your vehicle to an authorized dealer.
- When servicing electrical equipment, disconnect the negative terminal (-) of the battery.

After inspection and maintenance, check that there are no oil leaks, fluid leaks, or water leaks.

 **CAUTION**

- Replace filters and filter elements regularly. Blocked or damaged filters and elements can reduce the engine's power and impair its operation. Always use genuine parts for replacements. Also, oils and greases should be those recommended in this manual. Use of non-genuine parts, or oil and grease not recommended, may lead to failures.
⇒  P. 14-3
- When replacing the oil or coolant, be sure to have a container suitable for catching drained fluid ready.
- After replacing oil or coolant, dispose of it using the specified method. Disposing of it inappropriately will have an adverse impact on the environment. If you are unable to dispose of it yourself, ask the nearest authorized dealer.
- Do not climb on the engine. Doing so will cause damage or malfunctions if you step on pipes or other components.
- The muffler contains an oxidation catalyst and ceramic filter. Do not kick or knock these components, since the catalyst and/or ceramic filter could be damaged.
Water collecting in the muffler is slightly acidic and should not be touched. If you touch this water, rinse it off under a faucet.
- The BlueTec[®] exhaust gas aftertreatment continues to work for 2 minutes even after the starter switch is turned to "LOCK". If you need to disconnect the battery or an electrical system connector for inspection or servicing, wait for at least 2 minutes after shutting off the engine.

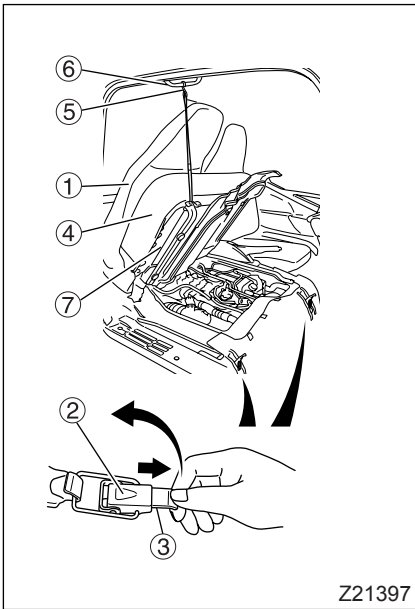

TO REACH THE ACCESS OPENING

<Crew-cab models>

1 Engine access opening

There is an opening under the assistant driver's seat which provides access to the engine for inspection and servicing.

Uncover and cover the opening as follows:

- To uncover the opening
 1. Tip the seatback ① forward.
 2. Fold back the floor mat. Release the two clamps ② by pulling the handle ③ down and then turning it up while still pulling it, holding only the end of the handle.
 3. Raise the seat cushion ④, then release the retaining hook ⑤ on the bottom of the seat cushion.
 4. Attach the retaining hook to the grip ⑥ beside the assistant driver's seat to hold the seat in place.
- To cover the opening
 1. Remove the retaining hook from the grip while supporting the seat cushion to prevent it from dropping.
 2. Attach the retaining hook to the spring ⑦ on the bottom of the seat cushion to hold the hook in place.
 3. Gently lower the seatback and seat cushion, then fasten the clamps to retain it.
 4. Return the floor mat and seatback to their original positions.

! CAUTION

- Be careful not to trap the seat belt or floor mat when closing the engine access opening.
- Completely fasten the clamps after closing the engine access opening.

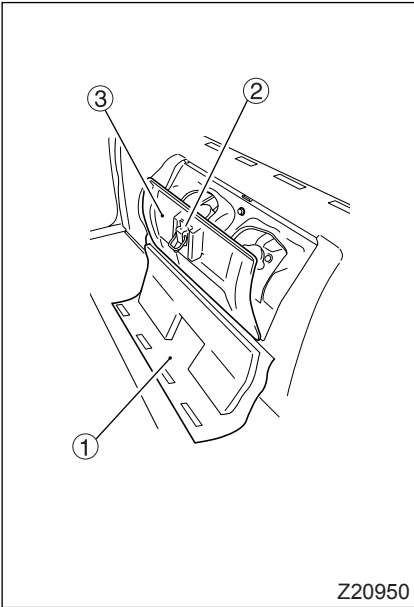

2 Power steering fluid and engine coolant level inspection opening

In front of the rear seat, there is an opening for inspecting and replenishing the power steering fluid and engine coolant.

Uncover and cover the opening as follows:

1. Remove the cover ①.
2. Raise the clamp ② to unhook it and then swing down the inspection opening cover ③.
Perform the above procedure in reverse to cover the opening.

TILTING THE CAB

<Vehicles other than Crew-cab models>

NOTE:

A Crew-cab cannot be tilted.

WARNING

- When tilting the cab, do so correctly using the method shown in this manual. If you raise or lower the cab using an incorrect method, you may be injured or trapped. Also, the cab may not lock completely. If the cab may not lock completely, the cab may lift up and cause a serious accident while the vehicle is in motion.
- Park on a flat level area before raising or lowering the cab. If the area is not flat and level, there is a risk that the cab may not lock completely when it is lowered. If the cab may not lock completely, the cab may lift up and cause a serious accident while the vehicle is in motion.

1 Preparation

WARNING

- Before tilting or lowering the cab, make sure that the area around the cab is clear of people and obstructions.
- Never tilt the cab with occupants inside.
- Never tilt the cab when the vehicle is on any kind of slope. The cab will move too quickly under the effect of inertia if it is tilted on a slope, possibly causing damage to various vehicle components. Doing so is dangerous as the hook may not engage completely when the cab is lowered.
- To ensure safety, two people should work together to tilt the cab if it has a roof deck or other heavy item attached to it. One person working alone could become unable to support the cab and have an accident as a result.
- If any heavy item of cargo is on the roof deck or in the cab, remove it before tilting the cab. Otherwise, its weight could cause the cab to move suddenly during tilting, resulting in an accident.
- Do not touch the steering wheel, gearshift lever, parking brake lever, or any other control in the cab while the cab is tilted.

CAUTION

If any item of cargo is in the cab, retain or remove it. Otherwise, it may tip or fall and get damaged when the cab is tilted.

NOTE:

Turn off the air conditioner before tilting the cab. Tilting the cab with the air conditioner running would cause the water that drains out of the air conditioner to leak into the cab.

- Park the vehicle on a flat and level surface and stop the engine.
Tilting the cab on a slope is dangerous since the cab could swing up unexpectedly. This could also damage the mechanism because of the excessive stresses on it.
- Prevent the vehicle from moving by pulling the parking brake lever and blocking the wheels with chocks.
- Put the gearshift lever in the “P” position.

- Remove water or other liquids from inside the cab before tilting. Also, remove any beverage from the cup holders whose container is open.
- Close both doors completely.
- Before tilting the cab, make sure there is adequate clearance in front of the cab and above it.

Clearance in front	1 m or more (3.3 ft. or more)
Clearance above	1 m or more (3.3 ft. or more)

If there are any obstructions within the clearance areas shown above, remove them.

- Collapse the radio antenna.

2 Tilting the cab

CAUTION

Raise the cab gently. Raising it quickly with great force could damage the cab tilt mechanism.

1. Pull lever A ①. With lever A still pulled, pull up lever B ②. Keep lever A pulled until the lever B has been fully raised.

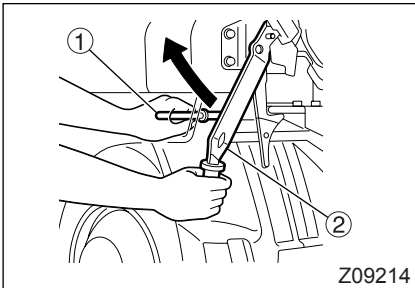

CAUTION

Lever B must only be raised when lever A has been pulled. If an attempt is made to raise lever B by force, it may be damaged as a result.

2. Grasp tilt grip ③ and pull lever C ④. The cab will rise slightly.

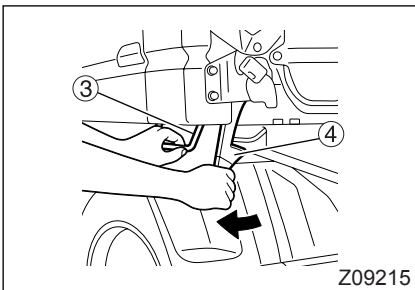

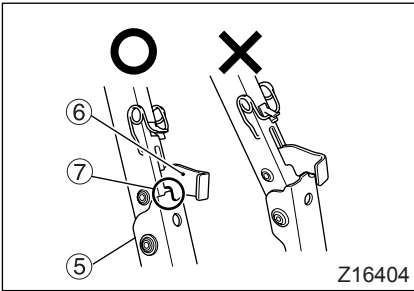

Z16404

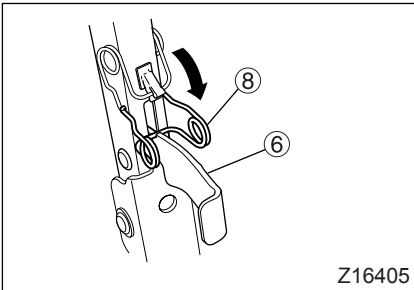

Z16405

3. Hold the tilt grip and raise the cab until the end of cab stay ⑤ engages with the notch ⑦ of the lock lever ⑥. The cab is secured when they are engaged.

4. Still holding the tilt grip, insert the retainer ⑧ into the notch of the lock lever.

WARNING

- Hold the tilt grip when raising the cab. If you raise the cab holding lever B or lever C, the cab lock mechanism may be damaged or the cab may not lock completely when the cab is lowered. Also, these may raise the cab and cause a serious accident while the vehicle is in motion.
- Be sure to insert the retainer into the notch of the lock lever. If the retainer may not insert completely, the cab may fall down and cause a serious accident.

3 Lowering the cab

WARNING

- Hold the tilt grip and support the cab while lowering it slowly. Your body may be trapped if the cab is lowered quickly or the cab may not lock completely.
- Before lowering the cab, make sure that you have not left rags, tools, etc. in the engine compartment. Flammable objects left inside the engine compartment can cause fires.

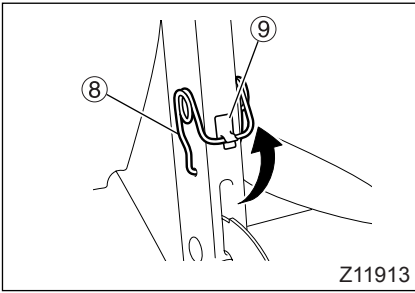

1. Release the retainer ⑧ and retain it in the clip ⑨.

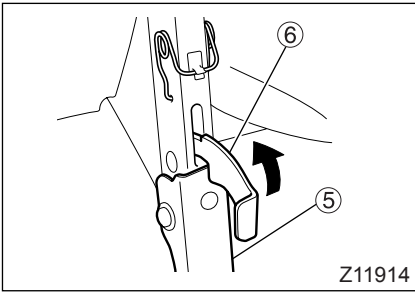

2. Hold the tilt grip to support the cab. Lift the lock lever ⑥ and fold the cab stay ⑤.

⚠ WARNING

- Hold the tilt grip when lowering the cab. If you lower the cab holding lever B or lever C, the cab lock mechanism may be damaged or the cab may not lock completely. Also, these may raise the cab and cause a serious accident while the vehicle is in motion.
- When you have unlocked the cab stay, immediately move your hands away from the lock lever. The cab stay will tip toward the rear of the vehicle, so your hands could otherwise get trapped.

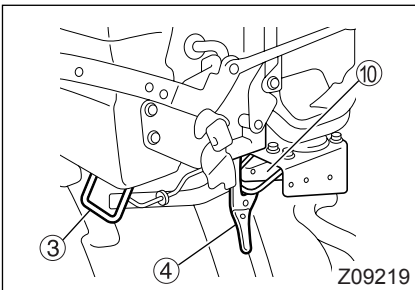

3. Still holding the tilt grip ③, lower the cab until the hook on lever C ④ engages with the cab mount ⑩.

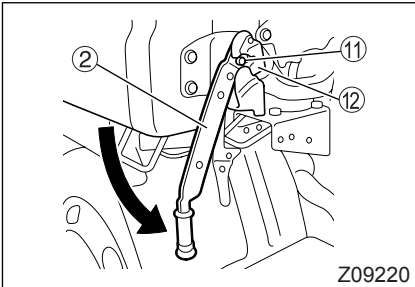

4. Push down lever B ② until the pin ⑪ engages with the latch ⑫.
If you cannot push down lever B, repeat the cab tilting procedure.

4 Checking locking of the cab

WARNING

After lowering the cab, confirm that the cab is locked in place. If the cab lock is not fully secure, the cab may lift up and cause a serious accident while the vehicle is in motion.

When the cab is lowered down, verify that the cab is locked by performing the following steps. If incomplete locking is identified, repeat the cab tilting procedure and lower once again. If incomplete locking still exists, never drive the vehicle and contact your authorized dealer.

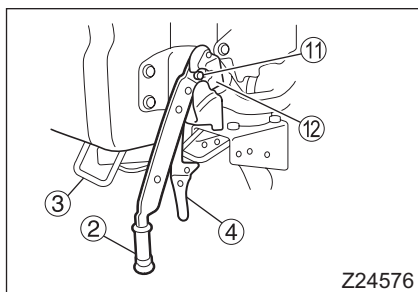

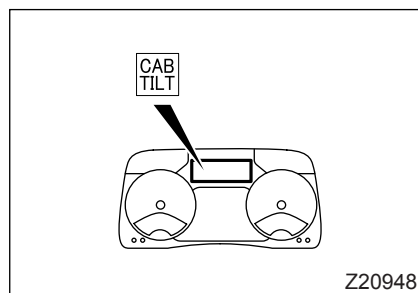

1. Confirm that the latch ⑫ is fully engaged with the pin ⑪. Also confirm that lever B ② does not move when it is pulled.
2. While pulling the lever C ④, pull the grip ③, to raise the cab and confirm that the cab does not rise.
3. If the cab does rise, repeat the cab tilt procedure.



4. Turn the starter switch to the "ON" position, then make sure the multi-information display does not indicate the  warning.

WARNING

Do not drive the vehicle while the multi-information display is showing . Vibration could cause the cab to rise. If the multi-information display is showing , tilt, lower and lock the cab again.

PRE-OPERATIONAL CHECKS

Be sure to perform the pre-operational checks for the items listed below at the start of each day's operation in order to ensure safe and comfortable driving. If you find anything unusual which you are unable to repair yourself, you should have this corrected at an authorized dealer before operating the vehicle.

CAUTION





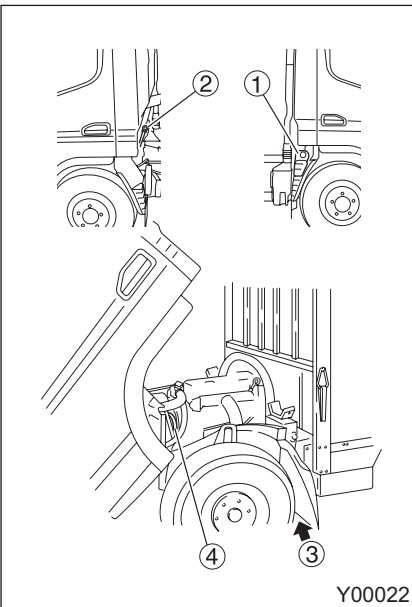

The engine oil level changes depending on the usage conditions. As part of daily inspections, check the oil level before driving the vehicle. If you use the vehicle under the following conditions, the engine oil may exceed FULL (for inspection) (O symbol) or drop below LOW on the oil level gauge quicker than usual.

- The vehicle is driven mostly at 20 km/h (12 mph) or slower.
- Operation involves starting and stopping the engine frequently (at 10-minute intervals or shorter).
- The vehicle is repeatedly driven for short distances of less than 10 km (6 miles).
- Regularly idling for long periods of time.

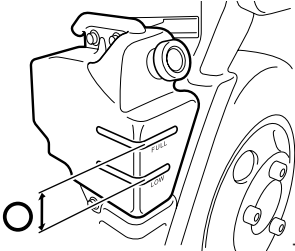
1 Before starting the engine

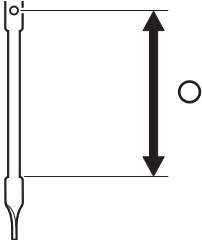

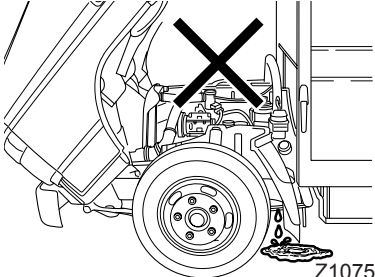
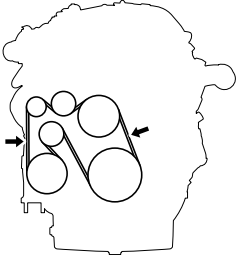
Y00022



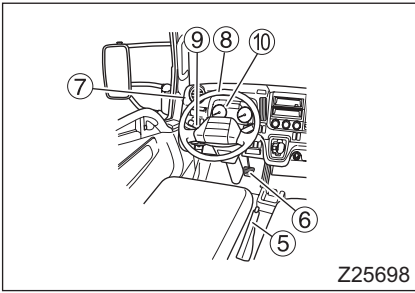



①	 <p>Z15730</p>	<p>Coolant level Check that the coolant level is between the "FULL" and "LOW" marks on the reservoir tank.</p> <p>⇒  P. 12-61</p>
②	 <p>Z25878</p>	<p>Engine oil level Check that there is sufficient engine oil using the oil level gauge. Change the engine oil if its level is above the circle mark on the oil level gauge.</p> <p>⇒  P. 12-24</p>
③	 <p>Z10751</p>	<p>Fuel, oil, coolant and other fluid leaks Check the underneath of the vehicle for any sign of leakage.</p>
④	 <p>Z22041</p>	<p>V-belt tension and damage Push the belt at either of the locations indicated by the arrows to check that the tension is appropriate. Also, check the belt for damage.</p> <p>⇒  P. 12-66</p>

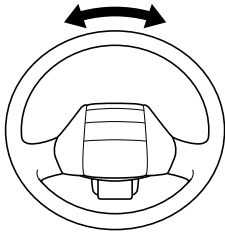

2 In the driver's seat

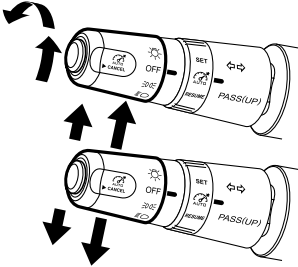

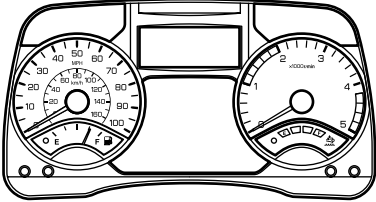

Start the engine and perform the following checks while allowing the engine to warm up.

<p>⑤</p>	<p>Z10681</p>	<p>Parking brake lever stroke Check that the parking brake lever stroke is 7 to 9 notches when the lever is pulled with a force of 294 N (66 lbs., 30 kgf). ⇒ P. 12-71</p>
<p>⑥</p>	<p>Z11955</p>	<p>Service brake pedal Make sure that the brake pedal has 0.1 to 3 mm (0.0039 to 0.12 in.) free play when pressed by finger. Check also that when the brake pedal is fully depressed, there is a gap of 10 mm (0.39 in.) or more between the pedal and the floor. ⇒ P. 12-70</p>
<p>⑦</p>	<p>Z21401</p>	<p>Brake fluid level Check that the brake fluid level is between the "MAX" and "MIN" marks on the reservoir tank. ⇒ P. 12-39</p>

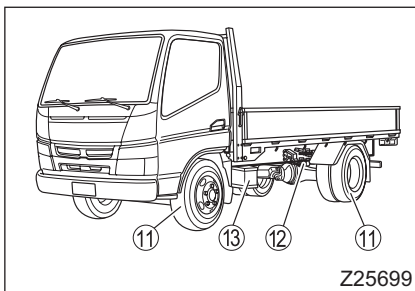
<p>⑧</p>	 <p>Z211947</p>	<p>Steering wheel free play While gently turning the steering wheel, check that its play is more than 10 mm (0.39 in.) and less than 20 mm (0.79 in.) when engine is turned off, and more then 5 mm(0.20 in.) and less than 50 mm (1.97 in.) when engine is idling.</p> <p>⇒  P. 12-68</p>
<p>⑨</p>	 <p>Z21403</p>	<p>Lighting system Make sure that each lamp lights up or flashes properly. Check lamp lenses for dirt and damage.</p> <p>⇒  P. 5-16</p>
<p>⑩</p>	 <p>Z21404</p>	<p>Gauge, warning/indicator lamp operation Check that gauges, warning lamps and indicators are working properly.</p> <p>⇒  P. 6-2</p>

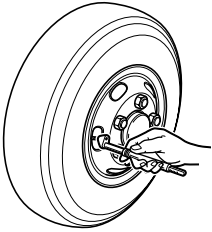

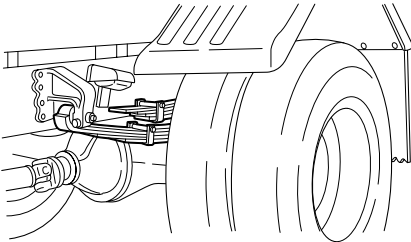
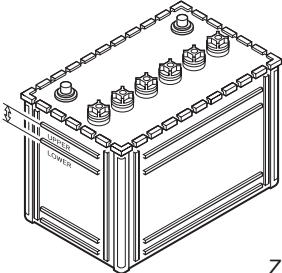

3 While walking around the vehicle

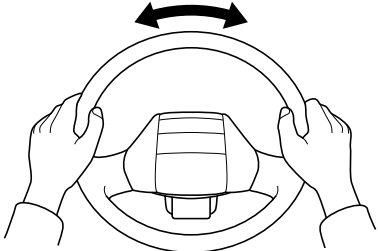

<p>⑪</p>	 <p>Z21588</p>	<p>Wheels and tires Check the disc wheels for cracks and other damage. Check the tires for proper inflation pressure, tread groove depth, foreign objects in grooves, cracks, uneven wear, softening and blistering.</p> <p>⇒  P. 12-72, 12-84</p>
<p>⑫</p>	 <p>Z10753</p>	<p>Suspension springs Check for broken springs and for the vehicles body tilting toward either side.</p>
<p>⑬</p>	 <p>Z15361</p>	<p>Battery fluid level Check that the battery fluid level is between the “UPPER” and “LOWER” level lines marked on the sides of the battery case.</p> <p>⇒  P. 12-90</p>

4 While driving at slow speeds

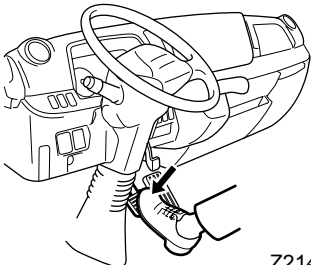
Perform the following checks while driving in a safe place at speeds lower than 20 km/h (12 mph).

<p>⑭</p>	 <p>Z11954</p>	<p>Steering wheel operation Check that the steering wheel does not vibrate or pull to one side and that does not require excessive force to turn the wheel. Also make sure that the steering wheel returns to its neutral position smoothly. ⇒  P. 12-69</p>
<p>⑮</p>	 <p>Z21408</p>	<p>Brake performance Depress the brake pedal and check that the brakes work effectively and evenly on all wheels. ⇒  P. 12-70</p>

LUBRICATION

Application and replacement of lubricants at the specified intervals is vital to the vehicle's performance, longevity, and safety. Following the maintenance schedule will provide optimal results.

⇒  P. 15-1

- If the vehicle is often used in demanding conditions, for example, on unpaved roads, near the coast, or in cold regions, lubricants should be applied and replaced more quickly than specified in the maintenance schedule. Consult an authorized dealer for the maintenance schedule appropriate to your vehicle operating conditions.
- Use only the lubricants specified. ⇒  P. 14-3
- Special lubricants must be used if the vehicle is used at temperatures below -23°C (-10°F). For details, refer to an authorized dealer.

 **CAUTION**

- Apply and replace lubricants regularly. Use of lubricants beyond their designed service life could cause bearings or other components to seize up and cause an accident.
- Any checking, application, or replacement of lubricants should be carried out with the vehicle parked on level ground.
- Wipe all lubricant inspection windows and filling ports carefully to prevent the entry of mud, trash, water, or other contaminants.
- Never flush waste oil into the sewers or onto the ground. Many auto parts stores, some service stations and authorized dealers will accept used motor oil for recycling.

GREASING**1 Grease nipples**

Remove all dust and dirt from the grease nipples before using them. Always use the recommended grease.

 **CAUTION**

Wipe away any grease that sticks to wires or rubber hoses and any grease that overflows from the grease nipples.

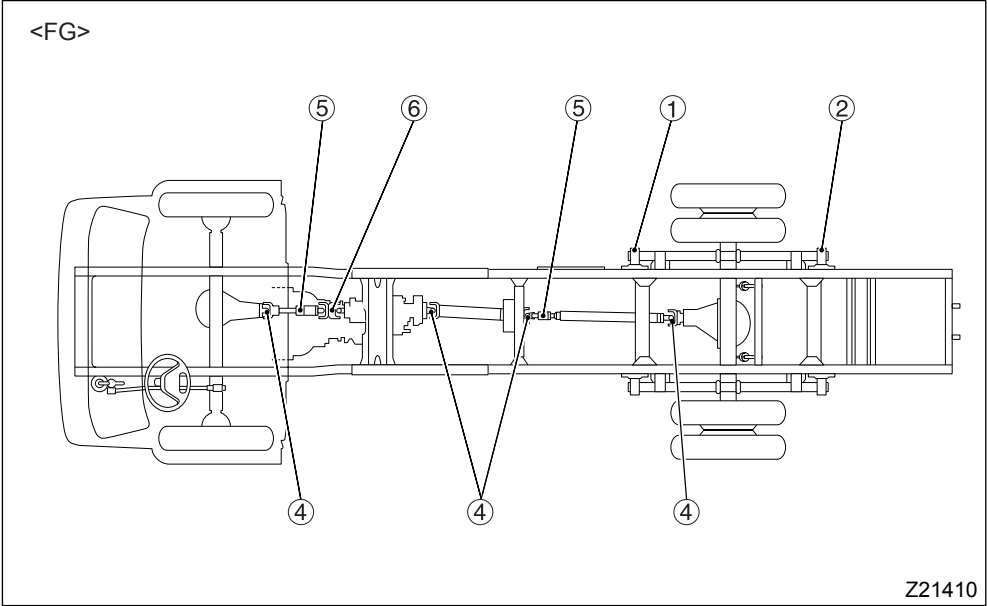
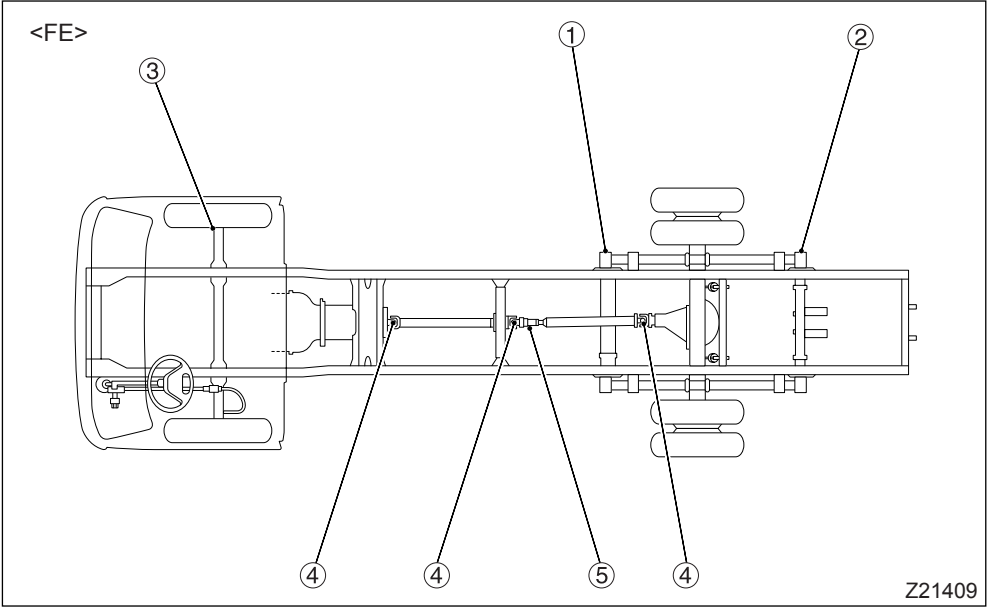

①

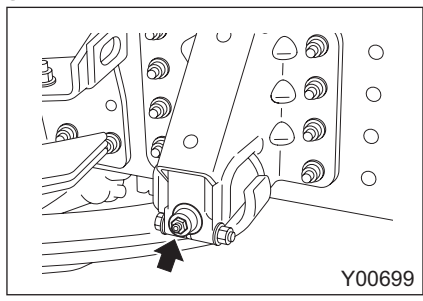

②

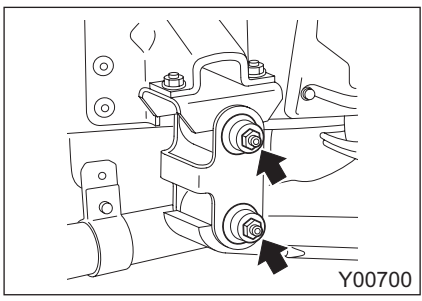

③

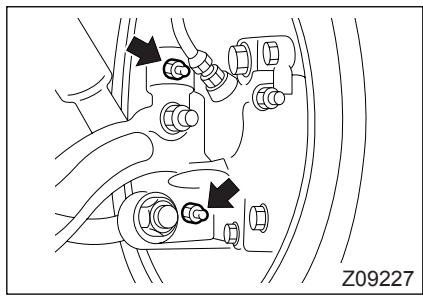

④

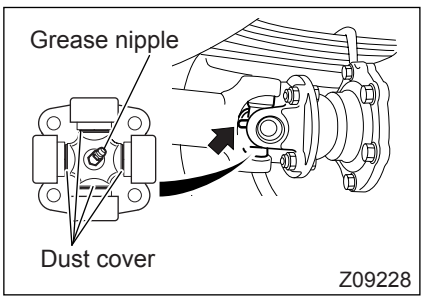

⑤

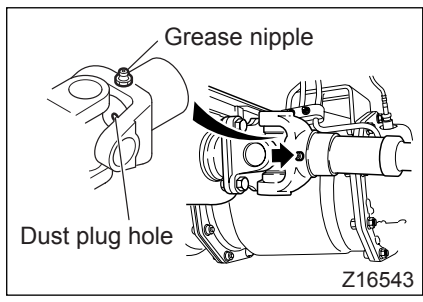

⑥

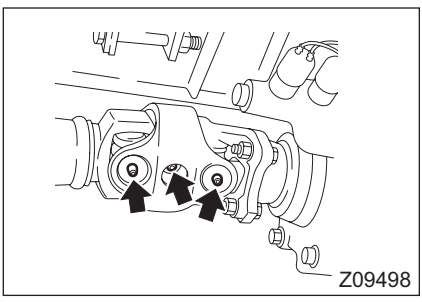

Recommended lubricant:
Chassis grease
NLGI No. 1 (Li soap)

Greasing intervals for rear spring pin	Every 32,000 km (20,000 miles) or every 24 months
--	---

- ① Rear spring pin, front (2 points each on both sides)
- ② Rear spring pin, rear (4 points each on both sides)

Greasing intervals for king pin bearing	Normal condition	Every 32,000 km (20,000 miles) or every 24 months
	Severe condition*	Every 32,000 km (20,000 miles) or every 12 months

*: Severe condition type (D)~(K)
 For information regarding the types of severe conditions, refer to page 15-2.

- ③ King pin bearing (4 points in total on both sides)

Recommended lubricant:
Wheel bearing grease
NLGI No. 2 (Li soap)

Greasing intervals	Every 32,000 km (20,000 miles) or every 24 months
--------------------	---

- ④ Propeller shaft universal joint
 Pump in grease until it comes out of the dust covers (at 4 places) of the universal joint.
- ⑤ Propeller shaft slip joint
 Pump in grease until it comes out of the dust plug hole of the slip joint.
- ⑥ Propeller shaft double cardan joint <FG>

NOTE:

The number of greasing points on the propeller shaft differs from model to model.

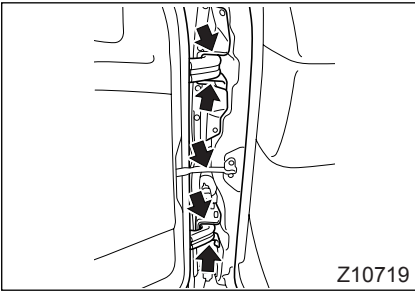

2 Door hinge (6 points in total on both sides; 12 points in Crew-cab models)

Greasing intervals	Every 80,000 km (50,000 miles) or every 48 months
--------------------	---

Recommended lubricant:
Chassis grease
NLGI No. 1 (Li soap)

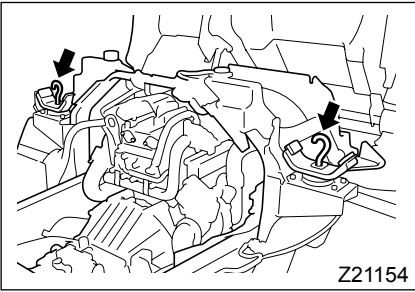

3 Anchor hooks (two places)

<Not applicable to Crew-cab models>
 Apply the grease to the entire anchor hooks.

Greasing intervals	Every 80,000 km (50,000 miles) or every 48 months
--------------------	---

Recommended lubricant:
Chassis grease
NLGI No. 1 (Li soap)

OILS AND FLUIDS





1 Engine oil

Performance, life, and startability of the engine depend to a large degree on the engine oil. Always use oil of the specified grade and viscosity.

Replacement intervals	Normal condition	Every 16,000 km (10,000 miles) or every 12 months
	Severe condition*	Every 8,000 km (5,000 miles)

*: Severe condition type (A)~(C)
 For information regarding the types of severe conditions, refer to page 15-2.

CAUTION

-  warning (amber) appears when the engine oil level has decreased, or that the oil quality has decreased due to fuel mixing with the engine oil.
Stop the vehicle in a flat area and check the engine oil level.   P. 12-26
- If the  warning (amber) and  warning (amber) are displayed alternately, replace the engine oil immediately. If the same oil is used even after the warning has been displayed, the engine may suffer various problems, including uncontrolled revving of the engine in an extreme case.
- When the vehicle is used under severe conditions, the engine oil level will rise more quickly than usual and so you should check the engine oil level daily, before starting to drive.

Recommended lubricant:

Engine oil

- API CJ-4 5W-30 (Standard), 10W-30 (In emergency case)
- ACEA C2 5W-30

CAUTION

- Use only the specified engine oil. Any other oils may contain substances that cause the ceramic filter inside the DPF to be loaded with particulate matter (PM) prematurely to the capacity and shorten the effective service life of the DPF.
- Change the engine oil at the specified intervals. During the regeneration process of the DPF, part of the fuel may mix into the engine oil while the PM is being removed by burning. If the engine oil is not changed at the specified intervals, it may excessively deteriorate due to mixing of fuel and could cause engine failure. In the worst case, the engine could spontaneously run at an abnormally high speed.

Quantity required:

Model	Quantity	
FE	Replacing oil	Approx. 7.2 liters (7.6 qts)
	Replace the oil and the filter at the same time	Approx. 7.7 liters (8.1 qts)
FG	Replacing oil	Approx. 5.5 liters (5.8 qts)
	Replace the oil and the filter at the same time	Approx. 6 liters (6.3 qts)

1.1 Checking

 **CAUTION**

The engine oil level changes depending on the usage conditions. As part of daily inspections, check the oil level before driving the vehicle. If you use the vehicle under the following conditions, the engine oil may exceed FULL (for inspection) (O symbol) or drop below LOW on the oil level gauge quicker than usual.

- Operating in slow vehicle speed (lower than 20km/h in average and more than 30% of total operation) or operations involving frequent starts and stops.
- Operations involving frequent engine starts and stops condition in 10 minutes and in 10km distance.
- Regularly idling for long periods of time.

NOTE:

- *Check the engine oil level with the vehicle parked on a level place. A correct engine oil level cannot be determined when the vehicle is not on level ground.*
- *Be sure to check the engine oil level before starting the engine at the time of pre-operational check. A correct engine oil level measurement cannot be expected if the engine is running, or the time after stopping the engine is too short. Let the engine stand at least 30 minutes after stopping it before checking the oil level.*

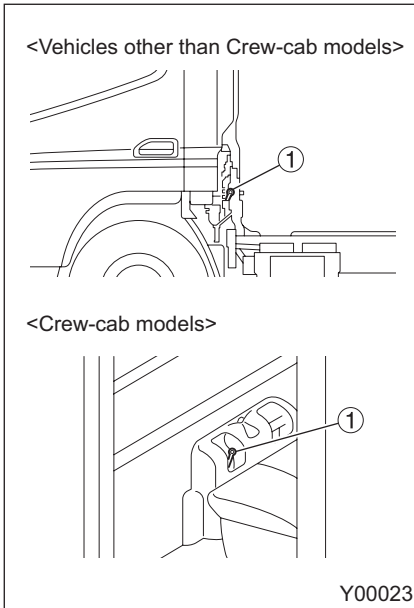

- The quantity of engine oil may increase due to the fuel that may have mixed with it when the DPF trapped PM is removed by burning. This does not indicate any abnormality. For the same reason, the engine oil can smell like fuel; this also does not indicate any abnormality.
- Except Crew-cab model vehicle, if it is hard to check the oil level due to certain body-mounted parts, tilt the cab. ⇨ P. 12-6

1. If the vehicle is a Crew-cab model, perform the procedure to reach to the power steering fluid and engine coolant level inspection opening. ⇨ P. 12-5
2. Remove oil level gauge ① and wipe off oil with a cloth.
3. Fully insert the oil level gauge in the crankcase, and gently draw it out.

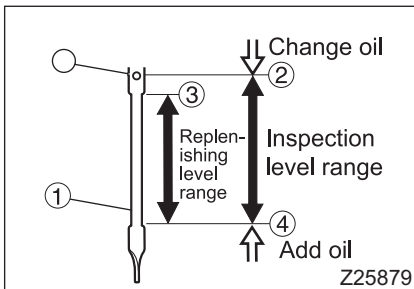

- ② (○ symbol): FULL (for inspection)
 ③ (above notch): HIGH (for refilling)
 ④ (below notch): LOW



4. Check the engine oil on the oil level gauge.
 - There is no problem if the oil level is within the inspection level range (between FULL (for inspection) and LOW) indicated in the figure.
 - The engine oil must also be changed if the oil level exceeds FULL (for inspection). ⇨ P. 12-27
 - Engine oil must be added if it is below LOW, or near LOW. ⇨ P. 12-26
 - The engine oil must also be changed if it is extremely dirty. ⇨ P. 12-27

CAUTION

If the oil level is above FULL (for inspection) (the circle mark) on the oil level gauge, change the engine oil immediately. This is an indication of deteriorated engine oil performance. Continued use of the same oil will cause engine failure and could even cause uncontrolled revving of the engine.

5. After the check, insert the oil level gauge into position and secure it properly.

1.2 Procedure for checking the engine oil level automatically from the driver's seat

1. Turn the starter switch "ON" and wait for 3 seconds or more.
2. The engine oil level is lower than the "LOW" position if the  warning (amber) is displayed in the multi-information display.
Replace the engine oil.
The engine oil level is appropriate if the  warning (amber) is not displayed in the multi-information display. The engine can safely be started.

NOTE:

- Stop the vehicle in a flat area when checking the engine oil level. The correct engine oil level cannot be measured if the vehicle is on a slope.
- After checking the engine oil level, immediately start the engine or return the starter key to the "LOCK" position. Failure to do so may cause the battery to discharge.
- The time that the engine needs to be stopped to accurately detect the oil level is being measured.

Start the engine and run it for 2 minutes or more if the  warning does not turn off after replacing the engine oil. Then check the engine oil again after stopping the engine for 1 hour or more.

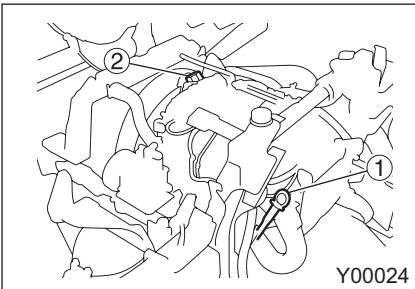

1.3 Adding oil

1. On Crew-cab models, the engine access opening is located under the assistant driver's seat. Clean the area around oil filler cap ② to prevent dust and dirt from entering the engine.
2. Remove the oil filler cap and add oil as necessary.



WARNING

Take care not to spill engine oil on the exhaust manifold, the starter or other hot sections of engine could catch fire. Wipe clean the oil if spilled.

! CAUTION

- The added oil should be of the same grade and viscosity as the oil originally placed in the engine.
- Do not add oil so that it exceeds HIGH (above notch) on the oil level gauge. Doing so will cause wasteful oil consumption, and cause the oil level gauge to exceed FULL (for inspection) (O symbol) quicker than usual.
- When adding engine oil, take care not to spill it.

If oil is spilled on a belt, the belt will slip on the pulleys.

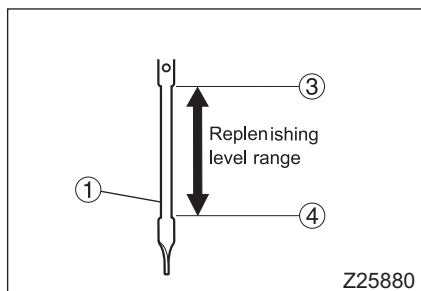

- ③ (above notch): HIGH (for refilling)
 ④ (below notch): LOW

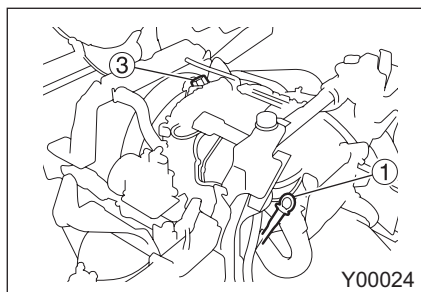

3. Close the oil filler cap, wait at least 5 minutes and check the oil level. If the oil is not within the level range indicated in the figure, add or remove oil to adjust the level.
4. Start the engine and warm it up until the coolant temperature gauge moves to around the 8th segment on the scale (center of indicator).
5. Stop the engine and wait at least 30 minutes before checking the oil level again. If the oil is not within the level range indicated in the figure, add or remove oil to adjust the level, and return to step 4 to inspect the oil level again.
6. Check that there are no oil leaks from the drain plug.

1.4 Replacement

NOTE:

You must reset the engine control unit every time after replacing the engine oil. ⇨ P. 12-29
 If you cannot do it yourself, have it done by an authorized dealer.

1. Clean the surfaces around the oil filler cap ③ and remove the oil filler cap.

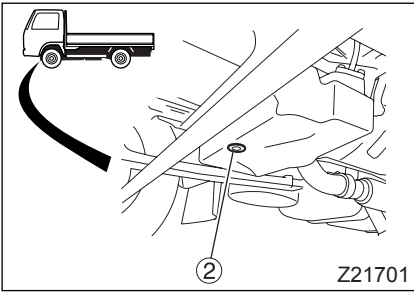

- Remove drain plug ② from the oil pan to remove the oil.
Drain the oil until only droplets come out.

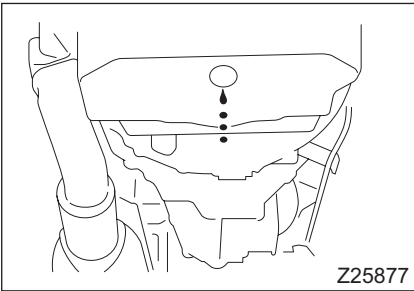

! WARNING
 The engine oil is extremely hot immediately after the vehicle has been operated. Take care to avoid being scalded when draining hot oil. Give the oil time to cool before draining it.

NOTE:
 Oil removal is quicker if performed soon after the vehicle has been stopped and while the oil is still warm.

- After oil has been drained out, clean the area around the drain plug hole.
- Replace the O-ring with a new one and tighten the drain plug.

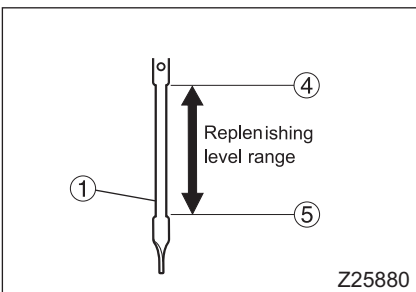

Tightening torque	30±10 Nm (3.0±1.0 kgfm, 22±7 ft.lbs.)
-------------------	---------------------------------------

- ④ (above notch): HIGH (for refilling)
 ⑤ (below notch): LOW

- Carefully add fresh engine oil through the oil filler.
- Close the oil filler cap, wait at least 5 minutes and check the oil level. If the oil is not within the level range indicated in the figure, add or remove oil to adjust the level.
- Crank the engine with the starter switch, then start the engine. ⇨ P. 5-8

8. Start the engine and warm it up until the coolant temperature gauge moves to around the 8th segment on the scale (center of indicator).
9. Stop the engine and wait at least 30 minutes before checking the oil level again. If the oil is not within the level range indicated in the figure, add or remove oil to adjust the level, and return to step 8 to inspect the oil level again.
10. Check that there are no oil leaks from the drain plug.
11. Reset the engine control unit. ⇨  P. 12-29

CAUTION

- Do not add oil so that it exceeds HIGH (above notch) on the oil level gauge. Doing so will cause wasteful oil consumption, and cause the oil level gauge to exceed FULL (for inspection) (O symbol) quicker than usual.
- If the engine is frequently run at high speeds or under heavy loads, the engine oil will deteriorate quickly and must be replaced sooner than specified.

WARNING

Take care not to spill engine oil as engine oil on the exhaust manifold, the starter or other hot sections of engine could catch fire. Wipe clean the oil if spilled.

1.5 Resetting the engine control unit

1. Turn the starter switch to “ON”. Do not start the engine.
2. Depress the accelerator pedal to the floor and keep it there for at least 20 seconds.
3. While still keeping the accelerator pedal depressed to the floor, pump the brake pedal at least 6 times.
When the engine control unit is reset, the  indicator (amber) appears on the display for about 10 seconds
4. Turn the starter switch to “LOCK”, and wait for 2 minutes.

⚠ CAUTION

After replacing the engine oil, reset the engine control unit. The engine control unit calculates the engine oil replacement time. The steps above are necessary in order to reset the data used for determining the engine oil replacement time.

2 Clutch control fluid

Replacement intervals	Every 64,000 km (40,000 miles)
-----------------------	-----------------------------------

Recommended oil: FUSO ATF SP III or Exxon Mobil ATF 3309

Clutch control fluid quantity

Quantity required	
Oil pan	Approx.2.0 liters (2.1 qts)
Total (including clutch control fluid in oil pan, oil filter and clutch control fluid cooler)	Approx.4.7 liters (5.0 qts)

2.1 Check, addition, and replacement

⚠ CAUTION

Do not check, add, and replace the clutch control fluid yourself. Have it done by an authorized dealer.

3 Transmission gear oil

Replacement intervals	Every 64,000 km (40,000 miles)
-----------------------	-----------------------------------

Recommended oil:

Gear oil

Classification	Viscosity	
	Condition	SAE viscosity number
API GL-3	General	80
	Warm region	90
API GL-4	General	80
	Tropical region	90

Quantity required:

Quantity required	Approx. 3.5 liters (3.7 qts) Plus approx. 0.2 liters (0.2 qts) for vehicle with standard PTO, or plus approx. 0.3 liters (0.3 qts) for vehicle with large-capacity PTO
-------------------	---

3.1 Check

⚠ WARNING

Do not check the oil level immediately after driving, as you could be scalded by extremely hot oil. Give the oil time to cool before performing the inspection.

NOTE:

Do not confuse the transmission oil inspection plug ① with the clutch control fluid inspection plug and drain plug ⑤, which are located nearer to the front of the vehicle than the transmission oil inspection plug.

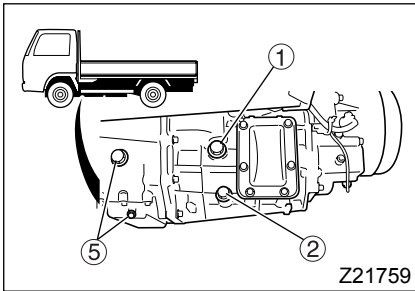

1. Remove the inspection plug ① and clean it.
 2. Check that the oil surface ③ reaches the opening of the inspection plug hole ④. If insufficient, add the oil from the inspection plug hole up to the opening.
- After one minute has passed, check that the oil is filled up to the opening of the hole.

⚠ CAUTION

The added oil should be of the same grade and viscosity as the oil originally placed in the transmission.

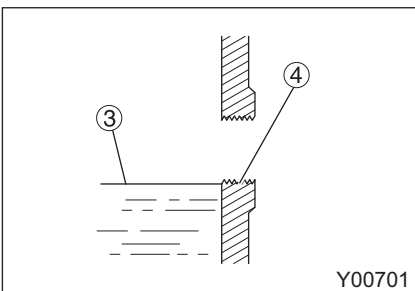

3. Replace the inspection plug gasket with a new one.
4. Install the inspection plug after coating its threads with the specified sealant.

Sealant	ThreeBond 1105
---------	----------------

Tightening torque	68.6 ± 14.7 N·m (51 ± 11 ft.lbs., 7.0 ± 1.5 kgf·m)
-------------------	--

3.2 Replacement

1. Place a container under the drain plug ②.
2. Remove the inspection plug ① and drain plug to let the oil flow out.

 <p>WARNING</p> <p>Do not replace the oil immediately after driving, as you could be scalded by extremely hot oil. Give the oil time to cool before draining it.</p>

NOTE:

- *Oil removal is quicker if performed soon after the vehicle has been stopped and while the oil is still warm.*
 - *Do not confuse the transmission oil inspection plug ① and drain plug ② with the clutch control fluid inspection plug and drain plug ⑤, which are located nearer to the front of the vehicle than the transmission oil inspection plug and drain plug.*
3. The drain plug is fitted with a magnet. Wipe off any metal particles sticking to the magnet.
 4. Replace the drain plug gasket with a new one.
 5. Coat the threads of the drain plug with the specified sealant.

Sealant	ThreeBond 1105
---------	----------------

6. After the transmission oil has drained out completely, install and tighten the drain plug.

Tightening torque	68.6 ± 14.7 N·m (51 ± 11 ft.lbs., 7.0 ± 1.5 kgf·m)
-------------------	--

7. Add oil through the inspection plug hole until it reaches the bottom of the hole.
Put your finger straightly into the inspection plug hole after one minute has passed, and check that the oil is filled up to the opening of the hole.
8. Like with the drain plug, replace the inspection plug gasket with a new one, coat the plug's threads with the specified sealant, and then install and tighten the plug.

Tightening torque	68.6 ± 14.7 N·m (51 ± 11 ft.lbs., 7.0 ± 1.5 kgf·m)
-------------------	--

4 Transfer gear oil <FG>

Replacement intervals	Every 64,000 km (40,000 miles)
-----------------------	--------------------------------

Recommended oil:

Gear oil

API classification GL-3 SAE 80 (general)

API classification GL-3 SAE 90 (warm regions)

API classification GL-4 SAE 80 (general)

API classification GL-4 SAE 90 (tropical regions)

Quantity required:

Quantity	Approx. 3.6 liters (3.8 qts)
----------	------------------------------

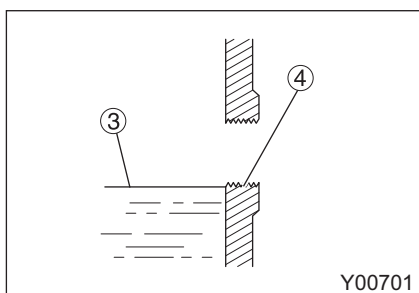
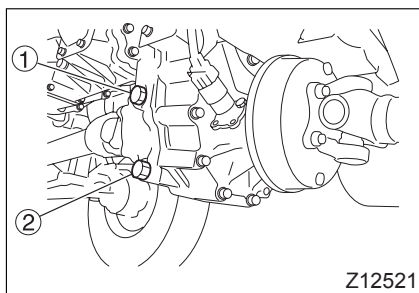

4.1 Check

! WARNING

Do not check the oil level immediately after driving, as you could be scalded by extremely hot oil.

Give the oil time to cool before performing the inspection.

1. Remove the inspection plug ① and clean it.
2. Check that the oil surface ③ reaches the opening of the inspection plug hole ④. If insufficient, add the oil from the inspection plug hole up to the opening.
After one minute has passed, check that the oil is filled up to the opening of the hole.

! CAUTION

The added oil should be of the same grade and viscosity as the oil originally placed in the transfer.

3. Replace the inspection plug gasket with a new one.

4. Coat the inspection plug's threads with the specified sealant and install and tighten the plug.

Sealant	ThreeBond 1105
---------	----------------

Tightening torque	68.6 ± 14.7 N·m (51 ± 11 ft.lbs., 7.0 ± 1.5 kgf·m)
-------------------	--

4.2 Replacement

1. Remove the inspection plug ① and the drain plug ② to allow the oil to drain.

	<p>WARNING</p> <p>Do not replace the oil immediately after driving, as you could be scalded by extremely hot oil. Give the oil time to cool before draining it.</p>
---	---

NOTE:

Oil removal is quicker if performed soon after the vehicle has been stopped and while the oil is still hot.

2. The drain plug is fitted with a magnet. Wipe off any metal particles sticking to the magnet.
3. Replace the drain plug gasket with a new one.
4. Coat the threads of the drain plug with the specified sealant.

Sealant	ThreeBond 1105
---------	----------------

5. After the transfer oil has drained out completely, install and tighten the drain plug.

Tightening torque	68.6 ± 14.7 N·m (51 ± 11 ft.lbs., 7.0 ± 1.5 kgf·m)
-------------------	--

6. Add oil through the inspection plug hole until it reaches the bottom of the hole. Put your finger straightly into the inspection plug hole after one minute has passed, and check that the oil is filled up to the opening of the hole.

7. Like with the drain plug, replace the inspection plug gasket with a new one, coat the plug's threads with the specified sealant, and then install and tighten the plug.

Tightening torque	68.6 ± 14.7 N·m (51 ± 11 ft.lbs., 7.0 ± 1.5 kgf·m)
-------------------	--

5 Axle housing gear oil

Replacement intervals	Every 64,000 km (40,000 miles)
-----------------------	--------------------------------

Recommended oil:

Gear oil

API classification GL-5

Below 40°C (104°F) SAE90

40°C (104°F) or higher SAE140



CAUTION

- Use oil conforming to GL-5, SAE140 if the vehicle is to be driven under heavy load conditions as for example driving up long uphill grades. Remember, however, that this oil is to be used only when the temperature is higher than 10°C (50°F).
- On vehicles with a limited slip differential, fill the differential with FUSO LSD GEAR OIL or an equivalent (GL-5, SAE90).

Quantity required:

Model		Quantity
FE		Approx. 4.5 liters (4.8 qts)
FG	Front axle	Approx. 3.0 liters (3.2 qts)
	Rear axle	Approx. 4.5 liters (4.8 qts)

These oil quantities are given only as guidelines. Be sure to check the correct oil level by removing the inspection plug as indicated below.

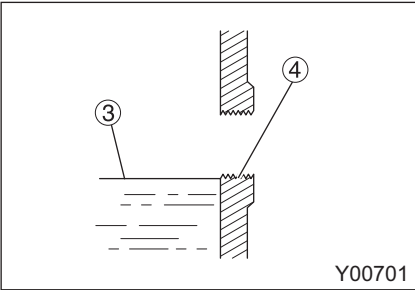
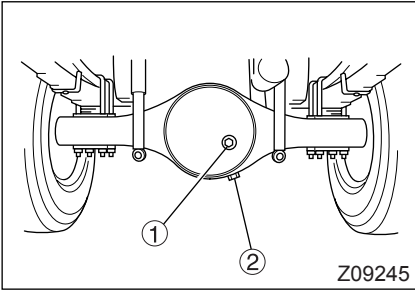

5.1 Check

! WARNING
 Do not check the oil level immediately after driving, as you could be scalded by extremely hot oil. Give the oil time to cool before performing the inspection.

1. Remove inspection plug ①.
2. Check that the oil surface ③ reaches the opening of the inspection plug hole ④. If insufficient, add the oil from the inspection plug hole up to the opening.

! CAUTION
 The added oil should be of the same grade and viscosity as the oil originally placed in the differential gears.

3. Replace the inspection plug gasket with a new one.
4. Install the inspection plug.

Tightening torque	110 ± 10 N·m (81 ± 7 ft.lbs., 11 ± 1 kgf·m)
-------------------	---

5.2 Replacement

1. Remove the inspection plug ① and the drain plug ② to allow the oil to drain.

! WARNING
 Do not replace the oil immediately after driving, as you could be scalded by extremely hot oil. Give the oil time to cool before draining it.

NOTE:
 Oil removal is quicker if performed soon after the vehicle has been stopped and while the oil is still warm.

2. The drain plug on the front axle is fitted with a magnet. Wipe off any metal particles sticking to the magnet.
3. Replace the drain plug gasket with a new one.

4. After oil has drained out completely, install and tighten the drain plug.

Tightening torque	$110 \pm 10 \text{ N}\cdot\text{m}$ ($81 \pm 7 \text{ ft}\cdot\text{lbs.}$, $11 \pm 1 \text{ kgf}\cdot\text{m}$)
-------------------	--

5. Add oil through the inspection plug hole until it reaches the bottom of the hole.
6. Like with the drain plug, replace the inspection plug gasket with a new one and install the plug by tightening it to the specified torque.

Tightening torque	$110 \pm 10 \text{ N}\cdot\text{m}$ ($81 \pm 7 \text{ ft}\cdot\text{lbs.}$, $11 \pm 1 \text{ kgf}\cdot\text{m}$)
-------------------	--

6 Brake fluid

Inspection intervals	At the time of pre-operational check
Replacement intervals	Every 24 months

Have the brake fluid replacement performed by an authorized dealer.

Recommended fluid:
Brake fluid SAE J1703
FMVSS No. 116, DOT3

 **WARNING**

- Be sure to use the recommended brake fluid.
- Use only one brand of recommended brake fluid. Mixing of different brands or types of fluid will change the properties of the fluid possibly resulting in a lower fluid boiling point and damaged brake components.

If you wish to change the brand of brake fluid, replace all the existing fluid in the brake system with the new brand fluid.

- Never allow engine oil, diesel fuel, gear oil, automatic transmission fluid, or any other mineral oil to mix with the brake fluid. When mixed with the brake fluid (even trace amounts), such oils will cause the rubber parts of the brake system to swell, and could cause brakes to become sluggish or to drag. Also, do not use containers which have been used for mineral oil for brake fluid.
- Because brake fluid is highly hygroscopic, it should be kept in a dry place both during refilling and storage. If brake fluid absorbs moisture, the boiling point is lowered, a condition which could result in vapor lock. This is very dangerous.
Do not open the reservoir tank cap when checking the brake fluid.
- If the brake fluid is used over long periods, its boiling point drops significantly due to the moisture it has absorbed, thereby increasing the likelihood of dangerous vapor lock. Therefore, be sure to change the brake fluid at the specified replacement intervals.

 **CAUTION**

Brake fluid dissolves paint. If you spill the fluid, wipe it clean or flush it off with water.

If not cleaned off, brake fluid can cause discoloration, corrosion, or cracks in the paintwork.

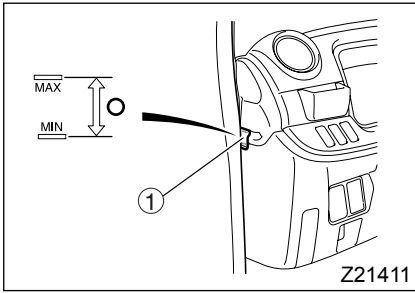

6.1 Check

The fluid level should be between the “MAX” and “MIN” lines on reservoir tank ①. Also check whether the reservoir tank contains foreign matter.

! WARNING

- Foreign matter in the reservoir tank could cause a failure of the brake system. If you see foreign matter in the reservoir tank, have it checked and cleaned by an authorized dealer.
- If the fluid level is unusually low, there is a fluid leak in the brake line. In this case, have your vehicle inspected at an authorized dealer.

NOTE:

The BRAKE warning lamp is illuminated when the brake fluid level drops below the “MIN” line.

! CAUTION

Do not open cap ② of reservoir tank for inspection purposes.

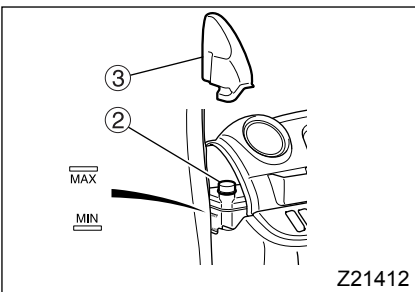

6.2 Adding fluid

1. If the fluid level is lower than the “MIN” line, remove cover ③, clean the surfaces around cap of reservoir tank, open cap ②, and add the recommended brake fluid up to the “MAX” line.
2. Close the cap firmly.

! WARNING

- The container used for adding brake fluid should be a clean one free of moisture, mineral oil, and dust.
- Be extremely careful not to let dust and other foreign matter enter the reservoir tank, as foreign matter in the tank could cause a failure of the brake system.

! CAUTION

Do not fill the brake fluid past the “MAX” line. Doing so will cause fluid leaks.

7 Power steering fluid

Replacement intervals	Every 32,000 km (20,000 miles) or every 12 months
-----------------------	---

Have an authorized dealer replace the fluid.

Recommended fluid:
Automatic transmission fluid
DEXRON II or DEXRON III type

CAUTION



When adding power steering fluid, be sure to use fluid of the same brand as the existing fluid. Mixing two or more different fluids will change their properties and could cause a failure.

NOTE:

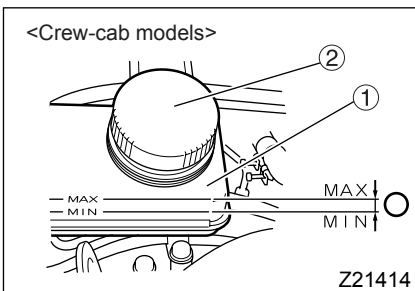
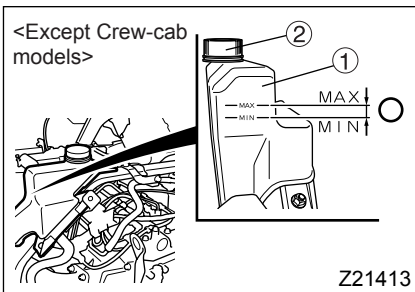
Inspect the power steering fluid level after stopping the engine and allowing the power steering fluid to cool. Increases in the fluid temperature cause increases in the fluid level, so an accurate inspection of the level is not possible unless the fluid is cold.



7.1 Inspecting and adding fluid

1. Tilt the cab. ⇒  P. 12-6
If the vehicle is a Crew-cab model, perform the procedure to reach to the power steering fluid and engine coolant level inspection opening. ⇒  P. 12-5
2. Observe the power steering fluid level in the reservoir tank ①.
3. If the fluid level is between the “MAX” and “MIN” lines, it is acceptable. Also, check whether the power steering fluid is dirty. If it is dirty, have it replaced by an authorized dealer.
4. If the fluid level is below the “MIN” line, clean the reservoir tank’s cap ② and the surrounding area then open the cap and add power steering fluid until it reaches the “MAX” line.
5. Securely fit the cap.

CAUTION

- Use a clean container when adding the power steering fluid. Never use a container that has held any other types of oil or fluid. Foreign matter in the fluid could result in a failure.
- Do not add more oil than the specified amount. Doing so will cause oil leaks.
- Insufficient oil can make the steering difficult or noisy and can damage power steering components.

WARNING

- Close the tank cap firmly; otherwise power steering fluid will leak and could catch fire. Also wipe clean any spilled fluid.
- If the power steering fluid level becomes abnormally low, fluid may be leaking. Have the steering system inspected by an authorized dealer.

FILTER ELEMENTS

1 Oil filter replacement

Replacement intervals	Every 16,000 km (10,000 miles) or every 12 months
-----------------------	---

CAUTION

- Oil filter element must not be cleaned and reused. Always replace the filter element with a new one.
- Replace the oil filter element simultaneously with engine oil change.
- When installing a filter case and an air-releasing plug, be careful not to let the O-ring twist and become damaged.

! WARNING

- Spilled engine oil should be wiped off clean. Oil remaining on the exhaust manifold, the starter or other hot sections of engine could catch fire.
- Do not replace the oil filter immediately after operating the vehicle since the engine, transmission, exhaust pipe, engine oil, and other items will be extremely hot. If you try to replace the oil filter immediately after driving the vehicle, you may be scalded. Give the engine time to cool before starting the job.
- When replacing the oil filter element, you will be working in a tight space. Be careful not to injure yourself on the edges of nearby components.

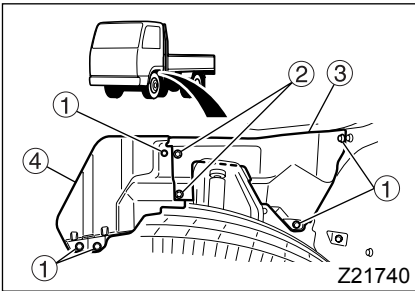

1. If the engine is cold, warm it up until the engine oil temperature reaches approximately 40°C (104°F). (It takes approximately 20 minutes of idling to raise the engine oil temperature from 0°C to 40°C (32°F to 104°F).) After the oil has heated, stop the engine.

NOTE:

Be sure to warm up the engine. Unless you warm up the engine, engine oil may spill out when you remove the oil filter case.

2. Tilt the cab. ⇒ P. 12-6
 With a Crew-cab model vehicle, remove the screws ① and unfasten the clips ② to remove the rear part ③ of the engine side cover.
 If it is difficult to access the engine inspection opening, remove the front part ④ of the engine side cover.
 Open the engine inspection opening.

⇒ P. 12-5

3. Clean the area surrounding the oil filter case to prevent dirt from entering the new filter element.
4. Turn the oil filter case ⑤ counterclockwise (about two and a half turns) to loosen it.
5. Remove the oil filter case air-releasing plug ⑥ by turning it counterclockwise. Replace the air-releasing plug with a new plug. Wait at least 5 minutes after removing the air-releasing plug to let the oil inside the case drain out completely. When replacing the engine oil, remove the oil filler cap and then the drain plug. ⇒ P. 12-27

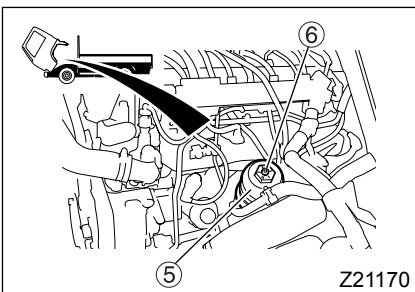

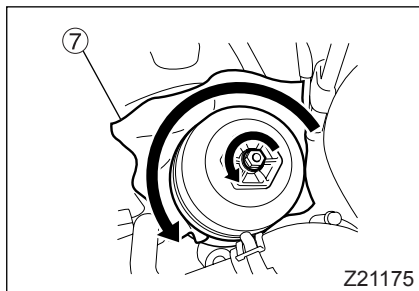

6. Remove the oil filter case by turning it counter-clockwise. Use a rag ⑦ to prevent oil from dripping down.

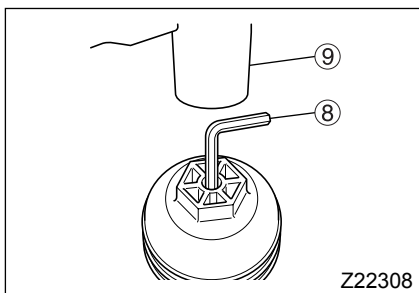

7. Remove the filter element ⑫ from the filter case. If the claw of the filter element is too firmly engaged to remove the element, insert an Allen wrench ⑧ and tap it with a hammer ⑨ to remove the element.

! CAUTION

Use a 4 mm or 5/32 inch Allen wrench ⑧. Using a larger Allen wrench may damage the air drain plug O-ring seal surface, while using a smaller one may pierce the element.

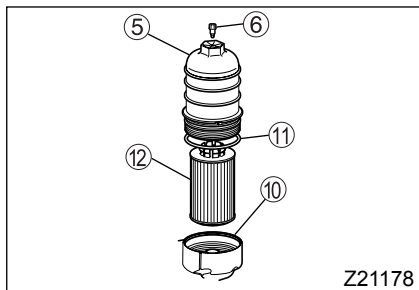

8. Clean the O-ring contact surface of the oil filter support ⑩ and the O-ring groove of the oil filter case.
9. Replace the O-ring ⑪ with a new one. Apply a light coat of engine oil to the new O-ring before installing it.

! CAUTION

Use only the O-ring supplied with a new replacement filter element.

10. Replace the filter element ⑫ with a new one; use only a genuine filter element.
11. Install the new filter element with its holed end facing down. Insert the holed end of the filter element snugly into the groove inside the oil filter support.
12. Install the air-releasing plug to the oil filter case. Use a new air-releasing plug provided with a new element.

Tightening torque	1.5 ± 0.6 N·m (1.1 ± 0.4 ft.lbs., 0.15 ± 0.06 kgf·m)
-------------------	--

13. Tighten the oil filter case.

Tightening torque	25 to 30 N·m (18.4 to 22.1 ft.lbs., 2.5 to 3.0 kgf·m)
-------------------	---

! CAUTION

Do not tighten the air-releasing plug and filter case beyond the specified torque. The air-releasing plug and filter case could be broken if over-tightened.

If the engine oil is replaced, add the necessary quantity of engine oil and reset the engine control unit. ⇒ P. 12-27

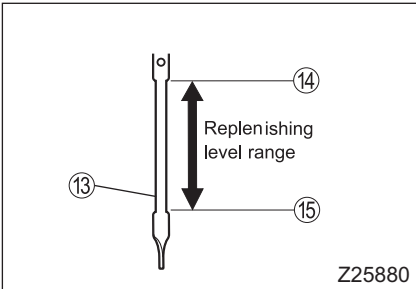

- ⑬ oil level gauge
- ⑭ (above notch): HIGH (for refilling)
- ⑮ (below notch): LOW

- 14. Crank the engine with the starter switch, then start the engine. ⇒ P. 5-8
- 15. Start the engine and warm it up until the coolant temperature gauge moves to around the 8th segment on the scale (center of indicator).
- 16. Stop the engine and wait at least 30 minutes before checking the oil level. If the oil is not within the level range indicated in the figure, add or remove oil to adjust the level, and return to step 15 to inspect the oil level again.
- 17. Check that there are no oil leaks from the oil filter or drain plug.

2 Fuel filter replacement

Replacement intervals	Every 32,000 km (20,000 miles) or every 12 months
-----------------------	---



WARNING

- Fuel is highly flammable and should be kept away from hot objects and open flames due to the risk of fire or explosion. Wipe up any spilled fuel.
- Do not replace the fuel filter element immediately after driving, as you could be scalded by extremely hot fuel filter. Give the fuel filter time to cool before performing it.
- After installing the fuel filter, confirm that no fuel is leaking out. Leaking fuel could cause a fire or explosion.
- Use only the fuel filter specified for your vehicle. Use of other filters could cause fuel to leak and cause a fire or explosion.
- When replacing the fuel filter element, be sure to use the special tool to remove and reinstall the fuel filter. If the fuel filter is reinstalled inappropriately, fuel could leak and the filter itself could become damaged, possibly resulting in a fire and/or explosion. If you do not have the special tool, please contact an authorized dealer.
- Be careful not to damage the filter case, as this could cause fuel leakage.
- When replacing the fuel filter, keep lit cigarettes and other sources of heat away from the vehicle and be sure to stop the engine. Not doing so could cause a fire.
- When replacing the fuel filter, you will be working in a tight space. Be careful not to injure yourself on the edges of nearby components.

! CAUTION

- The fuel filter element must not be cleaned and reused.
- Always replace with a new, genuine fuel filter element. Do not use the filter element beyond the recommended replacement intervals. Failure to observe these may damage the fuel injection parts.
- When replacing the filter element, take care to prevent foreign matter from entering the fuel system. Failure to do so will cause damage to the fuel injection system.
- Do not kick or hit the fuel filter. Doing so could damage the internal sensor.

NOTE:

The fuel filter is located in the left wheel base.

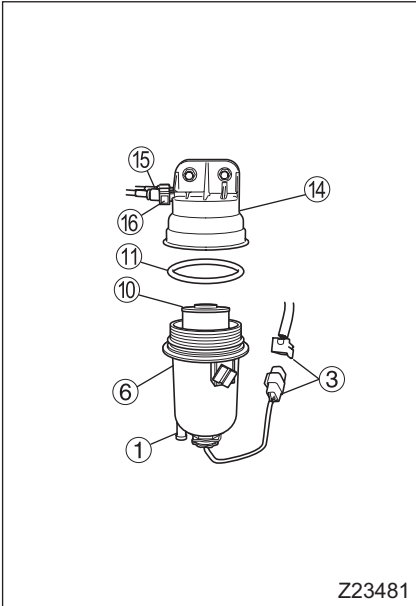

1. Clean the area around the filter to prevent dirt from contaminating the new filter element when it is installed later.
2. Place a container under the fuel filter to collect the fuel.
3. Disconnect the two fuel tubes. While pressing the lock button ⑯ at the connector section ⑮, pull off the tube. Apply a shop towel around the connector as some fuel will gush out when pulling the tube off.

Z23481

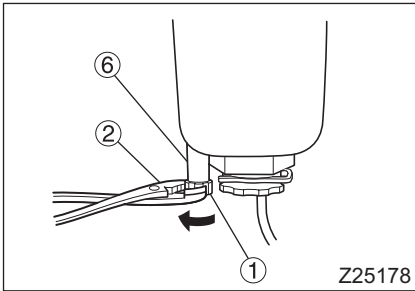

4. Using a marking tool such as a pen or marker, put alignment marks on the filter case ⑥ and drain plug ①.
5. Loosen the drain plug ① by turning it in the direction of the arrow indicated in the figure to allow the fuel in the fuel filter to drain out. Use pliers ② or a similar tool to loosen the plug.
6. After the fuel has been drained, turn the drain plug clockwise until the alignment marks on the drain plug and filter case are aligned with each other.

Tightening torque	1.5 N·m (1.1 ft.lbs., 0.15 kgf·m)
-------------------	--------------------------------------

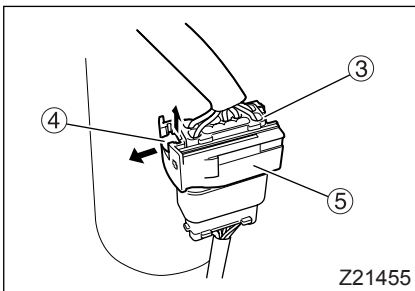

7. Disconnect the sensor connector ③. Do this after pulling up the connector's lock knob ④ and then pulling out the top part ⑤ of the connector.

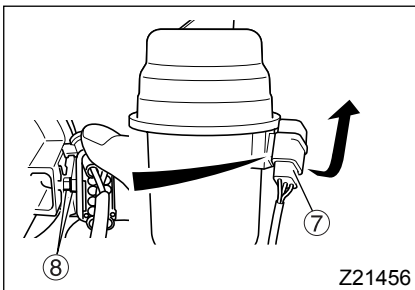

8. Disconnect the connector ⑦ from the fuel filter case by pulling the bottom part of the connector toward you to release the lock ⑧ and then pulling the connector directly upward.

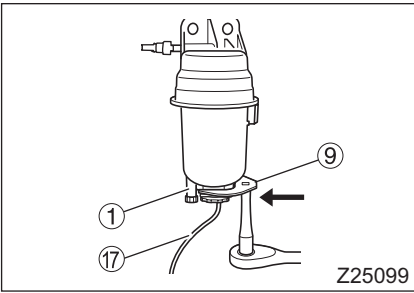

9. Insert the special tool ⑨ (separately available) horizontally from the opposite direction of the drain plug ①.

! CAUTION

- Be sure to insert the special tool horizontally from the opposite direction of the drain plug. If the special tool is not inserted from the opposite direction of the drain plug, the special tool will be inserted only partially, and a filter case might be damaged.
- When inserting the special tool, be careful not to catch sensor harness ⑰.

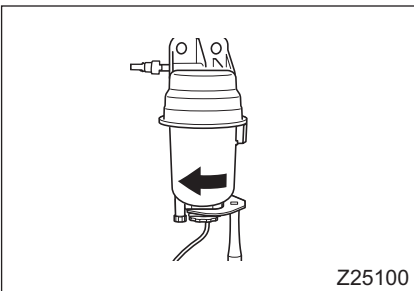
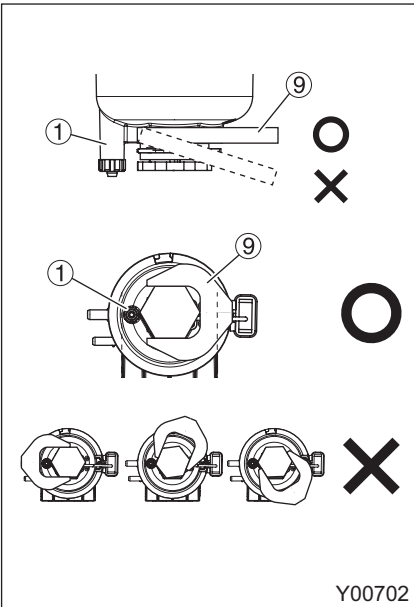

10. Remove the fuel filter case by turning it counter-clockwise. Let the fuel inside the case drain out.

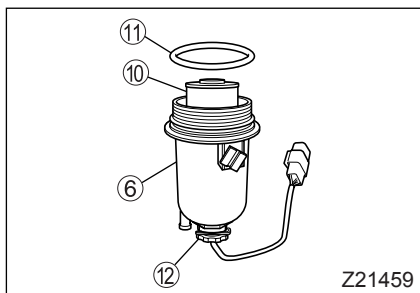

11. Remove the filter element out of the case by pulling it straight upward.
12. Replace the O-ring (11) of the fuel filter case (6) with a new one. After applying a light coat of engine oil to the new O-ring, install it on the fuel filter case.

! CAUTION

- Remove and install the filter element (10) in parallel with the axis of the filter case. Otherwise, the sensor (12) inside the case could become damaged.
- Use only the O-ring supplied with a new replacement filter element.

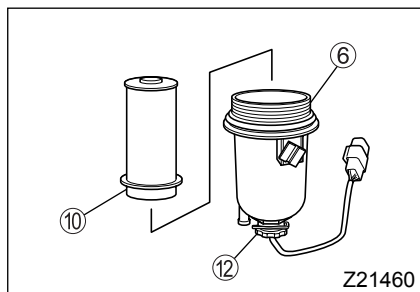

13. Install a new, genuine filter element into the filter case as shown in the illustration, paying attention to its direction. Insert the filter element in a straight line.

! CAUTION

- Install the fuel filter case carefully so as not to twist or damage the O-ring.
- Do not reuse the filter element.

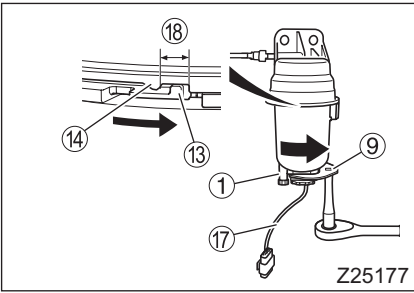

14. Insert the special tool ⑨ (separately available) horizontally from the opposite direction of the drain plug ①.

! CAUTION

- Be sure to insert the special tool horizontally from the opposite direction of the drain plug. If the special tool is not inserted from the opposite direction of the drain plug, the special tool will be inserted only partially, and a filter case might be damaged.
- When inserting the special tool, be careful not to catch sensor harness ⑰.

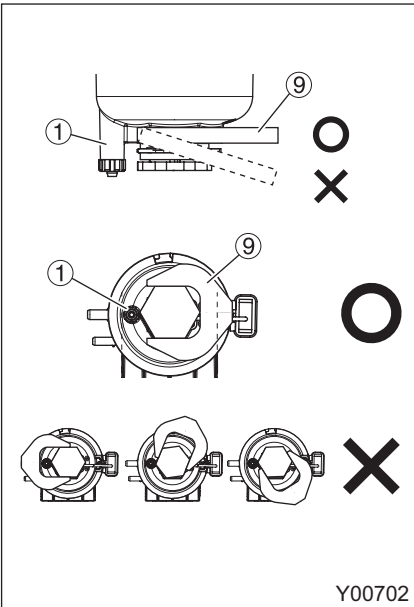

15. Install the fuel filter case by turning it clockwise. Make sure the projection ③ on the case is in the area ⑱ indicated in the figure past the projection ⑭ on the filter head. If it is difficult to confirm a projection, put alignment marks on the filter head and the case as a guide.

! CAUTION

Always check that the projection on the fuel filter case is in the area ⑱ indicated in the figure past the projection on the filter head. If the fuel filter case is turned insufficiently or excessively, fuel will leak or the fuel filter case will be damaged.

16. Install and connect the fuel filter case connector by following the removal procedure in reverse.
17. Connect the fuel tube connector  to the fuel filter. Insert the connector deep into the fuel filter, and insert a little further after a click is heard.
18. After connecting, hold the connector and move it slightly forward and backward to confirm that the connector is locked securely.
19. Bleed air from the fuel system as follows:
Turn the starter switch to "ON" for 30 seconds (do not crank in "START") and then set it to the "ACC" position to supply fuel to the fuel system.
20. Start the engine and check that there is no fuel leakage.

NOTE:

Air enters the fuel system while replacing the filter element and will prevent the engine from starting. Before starting the engine after replacing the filter element, bleed air from the fuel system.

3 Clutch control fluid filter

Replacement intervals	Every 64,000 km (40,000 miles)
-----------------------	-----------------------------------

3.1 Replacement



CAUTION

Do not replace the clutch control fluid filter yourself. Have it done by an authorized dealer.

4 Air cleaner element cleaning and replacement

Replacement intervals	Every 32,000 km (20,000 miles)
-----------------------	-----------------------------------

⚠ WARNING

When cleaning the air cleaner element, wear goggles and a mask to protect your eyes and respiratory organs from dust. Use a dust collector such as a vacuum to prevent dust from dispersing into the surroundings.

⚠ CAUTION

Clean the air cleaner element at the specified interval. Failure to follow this instruction will result in premature accumulation of PM in the DPF and eventually cause the systems to malfunction. On the contrary, unnecessarily frequent cleaning can damage the air cleaner element, allowing dust and other foreign matter to be drawn into the engine.

NOTE:

Even if the cleaning interval has not elapsed, clean or replace the element if clogging of the element causes a decrease in engine output.

- **Checking the air cleaner element condition with the dust indicator**

Check the dust indicator once a week. If the indicator's window ① shows a red signal, the air cleaner element is clogged. Clean the element immediately.

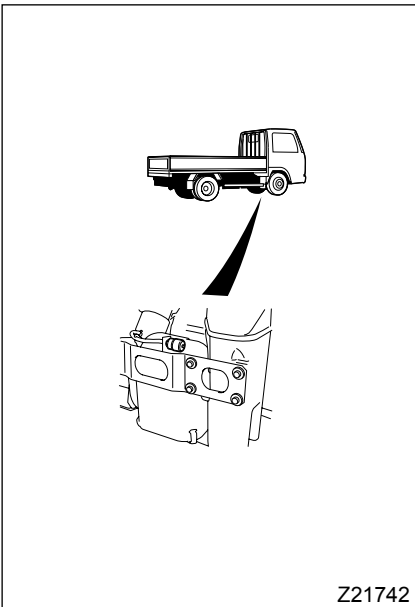

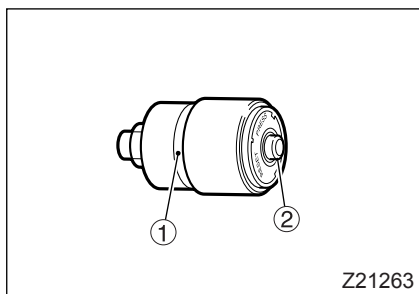

- **Resetting the dust indicator**

After cleaning the air cleaner element, push the reset button ②. The red signal will disappear from the dust indicator window.

The air cleaner is located in the illustrated position.

! CAUTION

When removing and reinstalling the cover, wear thick gloves to avoid injuring yourself on the edges of nearby parts.

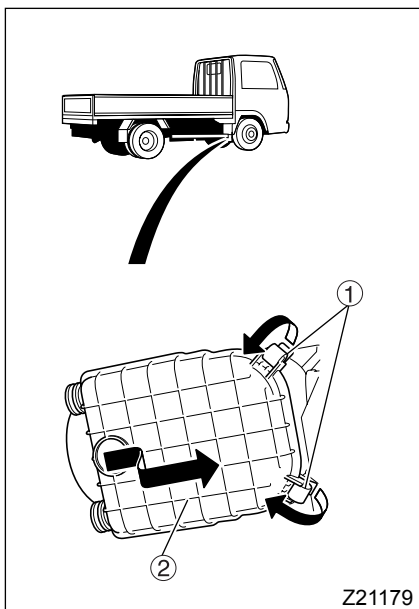

- **Removal**

1. Undo the two clamps ① and then pull the cover ② toward the clamps to remove it.

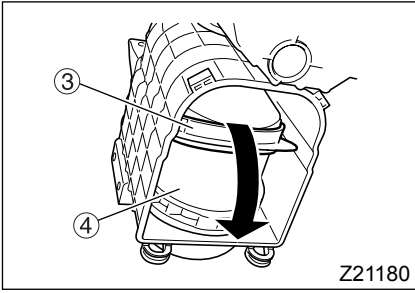

2. Move the lock lever ③ in the air cleaner element case to the “UNLOCK” position.

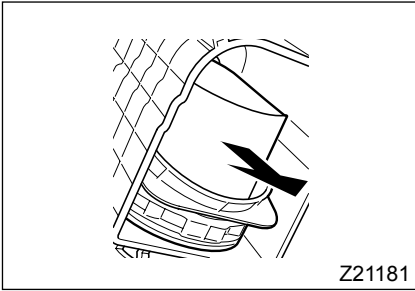

3. Pull the element ④ straight down to remove.

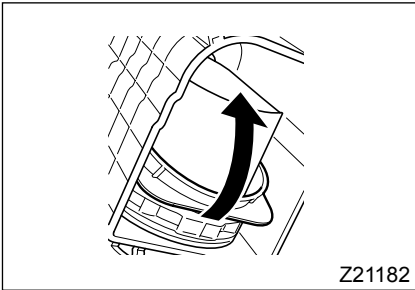

• **Installation**

1. Insert the air cleaner element into the air cleaner element case in a straight line.
2. Move the lock lever in the air cleaner element case to the “LOCK” position.

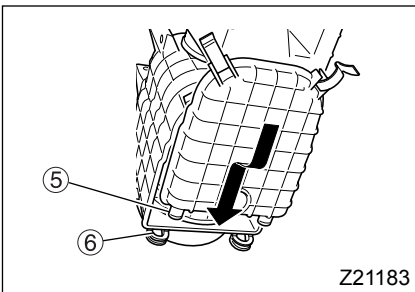

3. Install the cover on the case by inserting the guides ⑤ on the cover into the holes ⑥ in the case and then fasten the clamps.

! CAUTION

Install the air cleaner element in the case and close the case completely. A broken packing or loose fastening of the clamps will cause dust or other foreign material to be sucked in by the engine, causing the pistons and cylinder liners to prematurely wear.

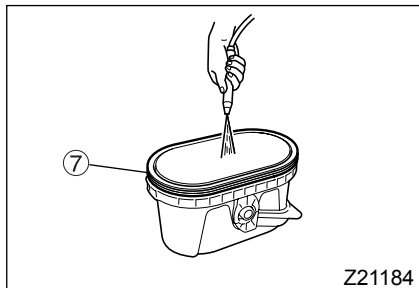

- **Inspection and cleaning**

1. Remove dust by blowing compressed air over every surface of the air cleaner element from its end fitted with the gasket ⑦.

! CAUTION

- **Dust can damage your health. Wear a dust mask to avoid inhaling dust while cleaning the air cleaner element. Also, wear thick gloves while removing and installing the cover.**
- **Keep the air pressure under 685 kPa (100 psi, 7 kgf/cm²) to prevent the element from being damaged.**
- **Do not strike the element or hit it against another object, since the element could be damaged.**
- **If the element is contaminated with oily soot or dust, replace it regardless of the scheduled replacement time.**

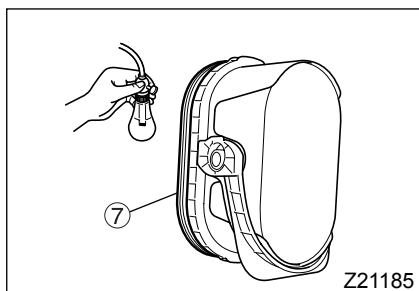

2. Position a light on the gasket side of the air cleaner element to check that there are no holes that allow light to leak in the element. Also check the gasket for cracks or other damage.

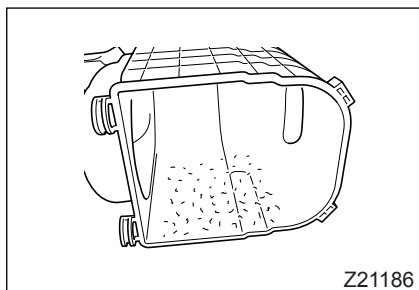

3. Clean the inside of the case and cover with a clean cloth. Closely clean the sealing sections.

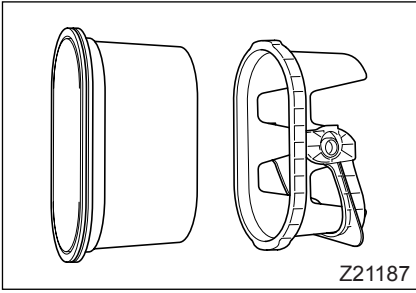

4. Replace the element with a new genuine element if the check reveals a faulty cleaner element or when the recommended replacement interval expires.
Remove the air cleaner element from the case and replace it with a new one.

DRAINING WATER FROM FUEL FILTER

If the  warning appears, there is an excessive amount of water in the fuel filter.
Drain the water as follows:

WARNING

- Fuel is highly flammable and should be kept away from hot objects and open flames due to the risk of fire or explosion. Wipe up any spilled fuel.
- When draining water from the fuel filter, keep lit cigarettes and other sources of heat away from the vehicle and be sure to stop the engine. Not doing so could cause a fire.
- Be careful not to injure yourself on the edges of nearby components while draining water from the fuel filter.
- Avoid damaging the fuel filter case, as this will cause fuel to leak.
- Do not drain water from the fuel filter immediately after driving the vehicle. The fuel filter is extremely hot immediately after the vehicle has been driven, so you could get burned. Give the fuel filter time to cool down before draining water from it.

CAUTION

Do not kick or hit the fuel filter. Doing so could damage the internal sensor.

NOTE:

The fuel filter is located in the left wheel base.

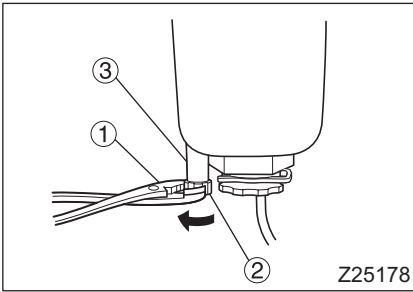

1. Place a container under the fuel filter to collect the water.
2. Using a marking tool such as a pen or marker, put alignment marks on the filter case ③ and drain plug ②. Using pliers ① or other suitable tool, slightly turn the fuel filter's drain plug ② counterclockwise to let water inside the filter drain out.
3. If only fuel starts draining out, tighten the drain plug by turning it clockwise until the alignment marks on the drain plug and filter case are aligned with each other.

Tightening torque	1.5 N·m (1.1 ft.lbs., 0.15 kgf·m)
-------------------	--------------------------------------

4. Bleed the fuel system. ⇒ P. 13-31
5. Start the engine and check that fuel does not leak.

WARNING

- The drain contains not only water but also fuel.
Be sure to wipe clean the surfaces around the fuel filter to remove all splashed fuel. Fuel remaining on the surfaces could cause a fire.
- Make sure fuel does not leak from the filter or from related parts. Any fuel leakage could cause a fire.

NOTE:

Air enters the fuel system while draining water from the fuel filter and will prevent the engine from starting. Before starting the engine after replacing the filter element, bleed air from the fuel system.

ENGINE COOLANT – INSPECTION AND REPLACEMENT

Inspection intervals	At the time of pre-operational check
Replacement intervals	Every 24 months

If the coolant becomes very dirty, replace it immediately regardless of the specified replacement intervals.

! CAUTION

- Continuing to use the coolant after the specified replacement period could damage the engine and cooling system components due to rusting and other problems. Replace the coolant at the specified replacement intervals.
- When replacing or adding coolant, be sure to use FUSO DIESEL LONGLIFE COOLANT or an equivalent. Using any coolant other than FUSO DIESEL LONGLIFE COOLANT or an equivalent could cause corrosion and damage to the radiator.

1 Recommended coolant

Use a coolant containing the FUSO DIESEL LONGLIFE COOLANT additive and soft water in the specified concentration.

Having both anti-freeze and anti-corrosion properties, the additive protects the cooling system all year around.

Replace and top off the coolant only with water containing FUSO DIESEL LONGLIFE COOLANT or an equivalent.

2 Water used with coolant

Use soft water with the properties shown in the following table. Do not use hard water from wells and rivers as it is liable to form scales and cause corrosion.

Total hardness	300 ppm or less
Sulfate SO ₄ ⁻	100 ppm or less
Chloride Cl ⁻	100 ppm or less
Total dissolved solids	500 ppm or less
pH	6 to 8

3 Using coolant additive

To prevent the cooling system freezing up and to minimize corrosion, use FUSO DIESEL LONGLIFE COOLANT or an equivalent. FUSO DIESEL LONGLIFE COOLANT is an ethylene-glycol-based antifreeze (SAE J814-C) with both anti-freeze and anti-corrosion properties. Dilute it with soft water to the specified concentration.

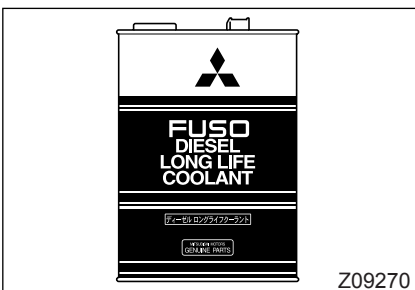

 **DANGER**

- FUSO DIESEL LONGLIFE COOLANT IS TOXIC. IF A PERSON HAS ACCIDENTALLY SWALLOWED IT, FORCE HIM/HER TO VOMIT AND CONSULT A DOCTOR IMMEDIATELY. IF IT SPLASHES IN THE EYES, IMMEDIATELY FLUSH THE EYES WITH WATER FOR MORE THAN 15 MINUTES, AND SEEK MEDICAL ATTENTION.
- SHOULD FUSO DIESEL LONGLIFE COOLANT COME IN CONTACT WITH YOUR SKIN, IMMEDIATELY WIPE IT OFF, AND THEN THOROUGHLY WASH YOUR SKIN WITH LOTS OF CLEAN WATER AND SOAP. IF YOU FEEL UNWELL OR PAIN ON YOUR SKIN, IMMEDIATELY SEEK MEDICAL ATTENTION.
IN THE EVENT OF CONTACT WITH YOUR CLOTHES, IMMEDIATELY FLUSH FUSO LONGLIFE COOLANT WITH WATER AND SOAP.
- DO NOT USE FUSO DIESEL LONGLIFE COOLANT IN A CLOSED OR POORLY VENTILATED SPACE. SHOULD YOU INHALE A LARGE AMOUNT OF GAS OF FUSO DIESEL LONGLIFE COOLANT, MOVE TO A PLACE WITH FRESH AIR AND KEEP YOURSELF WARM AND AT REST. IF YOU FEEL NAUSEOUS OR OTHERWISE ABNORMAL, IMMEDIATELY SEEK MEDICAL ATTENTION.
- CLOSE THE CAP OF THE FUSO DIESEL LONGLIFE COOLANT CONTAINER IMMEDIATELY AFTER USING THE PRODUCT.
- DO NOT STORE FUSO DIESEL LONGLIFE COOLANT WHERE CHILDREN COULD REACH AND ACCIDENTALLY DRINK IT.
- FUSO DIESEL LONGLIFE COOLANT IS FLAMMABLE; AVOID EXPOSING IT TO OPEN FLAME.
- WHEN HANDLING FUSO DIESEL LONGLIFE COOLANT, WEAR AN ORGANIC GAS MASK, PROTECTION GOGGLES, OIL-RESISTANT GLOVES, AND/OR PROTECTIVE APRON AS NECESSARY.

CAUTION

- Do not use methanol-based or methoxypropanol-based antifreeze products. They can severely damage the engine.
Never mix FUSO DIESEL LONGLIFE COOLANT with other brands of long-life coolant or any antifreeze or corrosion-preventive additives. Doing so would reduce the performance of the coolant. If a different long-life coolant has been used and the FUSO DIESEL LONGLIFE COOLANT is to be used, be sure to thoroughly flush the cooling system.
- Do not fill only the water. Doing so reduces the concentration of coolant and decreases the corrosion prevention and antifreeze properties.

Use the following table to determine the correct concentration of FUSO DIESEL LONGLIFE COOLANT according to the lowest temperature at which your vehicle is to be operated.

FUSO DIESEL LONGLIFE COOLANT concentration (in volume percentage)

Lowest temperature °C (°F)	-10 (14) or higher	-15 (5)	-20 (-4)	-25 (-13)	-30 (-22)	-35 (-31)	-40 (-40)
Concentration (%)	50	50	50	50	50	55	60

Coolant quantity	
Vehicles other than those specified below	Approx. 13.7 liters (14.5 qts)
Crew cab (with rear air conditioner)	Approx. 14.8 liters (15.6 qts)
Crew cab (with rear heater)	Approx. 14.9 liters (15.7 qts)

NOTE:

Vehicles are shipped with a 50% concentration of FUSO DIESEL LONGLIFE COOLANT and can safely operate at temperatures down to -30°C (-22°F).

CAUTION

Use **FUSO DIESEL LONGLIFE COOLANT** at a concentration of between 50% and 60%. The proper concentration under normal temperatures is 50%. At a concentration below 30%, this additive performs poorly as an anticorrosive, while at a concentration exceeding 60%, it performs poorly as an antifreeze.

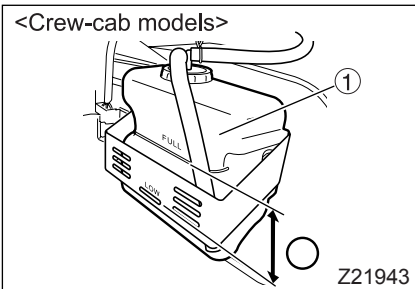
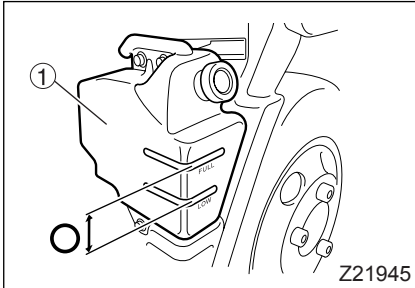

4 Checking the coolant level

NOTE:

- Always check the coolant level before starting the engine when the coolant temperature is low. When the coolant is hot, it expands, making the level look higher than it actually is.
- Deposition may occur in the reservoir tank but this will not cause any problem.
- The coolant level is sufficient if it is between the "FULL" and "LOW" marks on the coolant reservoir tank ①.
- If the coolant level is below the "LOW" line, make sure coolant is not leaking from the cooling system then add coolant until it reaches the "FULL" line.
- Check for coolant leakage from the radiator and radiator hoses.
If you find water on the ground from which your vehicle has been moved after parking, coolant is probably leaking.
- If the coolant level is abnormally low and quickly drops again when coolant has been added, coolant may be leaking from the cooling system. Have the vehicle inspected by your nearest authorized dealer.

5 Adding coolant

CAUTION

- Coolant should normally be added through the reservoir tank without opening the pressure cap on the surge tank.
- When adding coolant, use a new coolant additive of the same brand and concentration as the additive that is already in the vehicle.
- Adding only water reduces the concentration of the coolant already in the system, resulting in less protection against freezing and corrosion. Additional coolant should always contain the correct concentration of the additive and soft water.

5.1 Adding coolant during pre-operation checks

1. If the coolant level is below the “LOW” mark, remove the cap from the reservoir tank, and refill the tank with the correct concentration of FUSO DIESEL LONGLIFE COOLANT and soft water to the “FULL” mark.
2. Refit the cap securely after adding coolant.

5.2 Adding coolant following an engine over-heat

If the engine overheats, the amount of coolant may be insufficient not only in the reservoir tank but also in the radiator.

Refer to “IF THE ENGINE OVERHEATS” with regard to the adding coolant in situations where the engine has overheated. ⇨  P. 13-8

WARNING

Never remove the pressure cap while the coolant is still hot. Carelessly removing it is dangerous since boiling coolant and hot steam will push out and could scald you. Only after the coolant has cooled down sufficiently, remove the pressure cap by gripping it using a folded piece of thick cloth and opening it slowly.



6 Replacement

Be sure to flush the cooling system when replacing the coolant.

WARNING

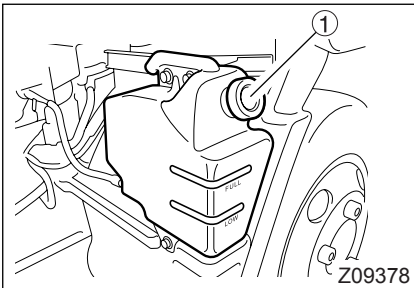
- Do not replace the coolant immediately after operating the vehicle since the engine, radiator, coolant, and other items will be extremely hot. If you attempt drain the coolant immediately after driving the vehicle, you may be scalded. Allow the coolant time to cool before starting the job.
- Never remove the pressure cap while the coolant is still hot. Carelessly removing it is dangerous since boiling coolant and hot steam will push out and could scald you. Only after the coolant has cooled down sufficiently, remove the pressure cap by gripping it using a folded piece of thick cloth and opening it slowly.
- Tighten the pressure cap before operating the engine. If the engine speed is increased with the pressure cap left open, the coolant will overflow from the pressure cap opening as its temperature rises.



1. Place a suitable container under the radiator drain cock to collect the engine coolant.
2. Remove the cap ① from the reservoir tank.
3. Tilt the cab. ⇨  P. 12-6
If the vehicle is a Crew-cab model vehicle, perform the procedure to reach to the power steering fluid and engine coolant level inspection opening. ⇨  P. 12-6

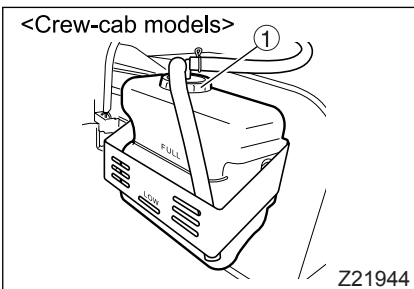

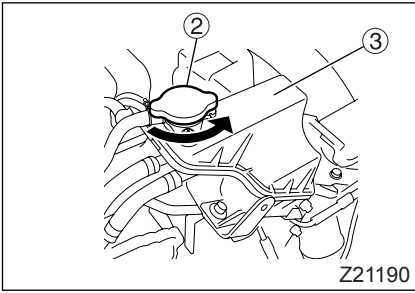

- Remove the pressure cap ② from the surge tank ③ by turning it counterclockwise.

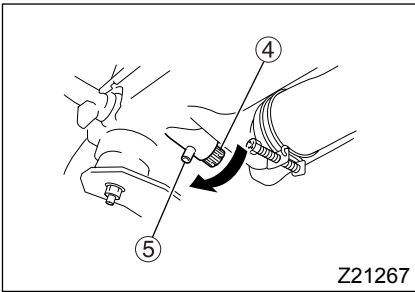

- Open the radiator drain cock ④ to drain the engine coolant.

NOTE:

You can prevent splashes from draining engine coolant by connecting a hose (commercially available with a 7 mm (0.28 in.) inside diameter) to the drain cock nipple ⑤.

- After the coolant has been completely drained, close radiator drain cock.

Tightening torque	$2.5 \pm 0.5 \text{ N}\cdot\text{m}$ ($1.8 \pm 0.4 \text{ ft}\cdot\text{lbs.}$, $0.25 \pm 0.05 \text{ kgf}\cdot\text{m}$)
-------------------	--

- Flush the cooling system.
 Pour soft water (preferably after heating moderately) through the pressure cap opening. Refit the pressure cap tightly by turning it clockwise. If the vehicle is not a Crew-cab model vehicle, lower the cab.
 Start and run the engine until the coolant temperature indicator on the multi-information display shows the 8th segment on the scale. Stop the engine after 10 minutes and then drain out the engine coolant. Be careful because the coolant is very hot.
 Repeat the above procedure until the water is free of dirt.
 For details on handling the multi-information display, refer to page 6-7.

! CAUTION

If the radiator hoses are restricted or the coolant is more contaminated than usual, have your vehicle inspected at an authorized dealer.

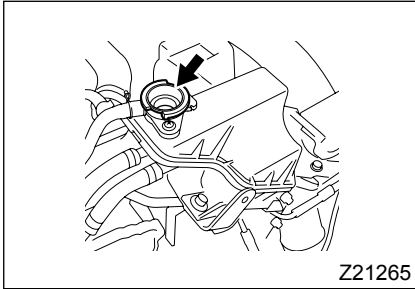

8. Make sure the radiator drain cock is tightened securely.
9. Tilt the cab. If the vehicle is a Crew-cab model vehicle, perform the procedure to reach to the power steering fluid and engine coolant level inspection opening. ⇨ P. 12-6
10. Pour coolant (FUSO DIESEL LONGLIFE COOLANT plus soft water) up to the top of the pressure cap opening. Pour the coolant slowly to prevent air from mixing with it.

NOTE:

When refilling the radiator on a Crew-cab model vehicle, pour coolant slowly to prevent it from overflowing the filler port.

11. Check that the coolant level in the pressure cap opening does not go down, then fit the pressure cap (turn it clockwise until it is tight).

! CAUTION

If air is not completely removed from the cooling system, this may lead to reduced cooling efficiency and engine parts failure. After replacing the coolant, drive the vehicle and then check the coolant level.

12. If the vehicle is not a Crew-cab model vehicle, lower the cab.
13. Fill the reservoir tank with coolant (FUSO DIESEL LONGLIFE COOLANT plus soft water) to the "FULL" line, then replace the cap.
14. Start the engine and keep it running at a speed slightly higher than the specified idling speed to expel air from the cooling system. When the coolant temperature indicator shows the 8th segment on the scale, allow the engine to idle for at least 10 minutes before stopping it, if possible.
15. Wait until the engine is cooled.
If the vehicle is not a Crew-cab model vehicle, tilt the cab.
If the vehicle is a Crew-cab model vehicle, perform the procedure to reach to the power steering fluid and engine coolant level inspection opening.
16. Open the pressure cap and, if the coolant level is too low, add coolant until it reaches the top of the pressure cap opening.

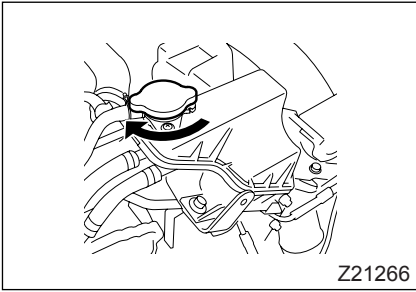

17. Screw the pressure cap down tightly by turning it clockwise.

NOTE:

Be sure to screw the pressure cap tightly. Otherwise, boiling water and steam under high pressure will push out if the engine overheats.

18. If the vehicle is not a Crew-cab model vehicle, lower the cab.
If the vehicle is a Crew-cab model vehicle, cover the power steering fluid and engine coolant level inspection opening.
19. Run the engine a few more minutes to make sure that there are no coolant leaks.
20. Make sure that the coolant level in the reservoir tank is in the specified range. Add coolant if necessary.

7 Cleaning the intercooler and radiator core

If the front of the intercooler or radiator gets clogged with dirt or dust, cooling efficiency will decrease. It could also be a cause of rust. Clean the intercooler and radiator at regular intervals. → P. 12-101

V-BELTS – INSPECTION AND ADJUSTMENT

The belt is kept adjusted to the appropriate tension by the auto-tensioner, so you do not need to adjust the belt tension. However, you should check that the auto-tensioner is working properly.

 **WARNING**
Always stop the engine before inspecting or adjusting belts.
Ensure that the engine cannot be started while you are performing checks or adjustments.



CAUTION

- If the belt is found to be damaged, have it replaced by an authorized dealer as soon as possible. The engine could fail if the belt breaks.
- Prevent the V-belt from any contact with oil or grease during inspection.
If soiled with oil or grease, the belts will slip and this will shorten their service life.

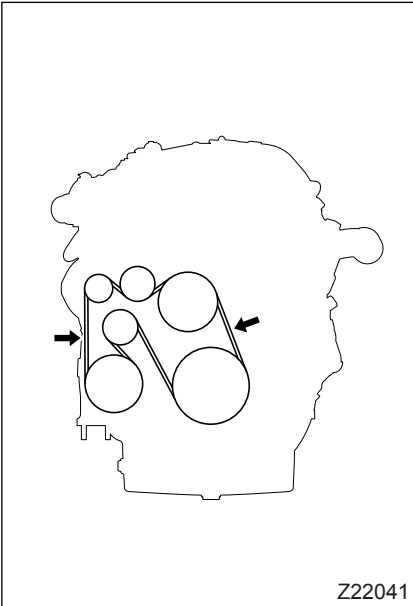
Inspection	At the time of pre-operational check and every 32,000 km (20,000 miles) or every 12 months
------------	--



1 V-belt inspection

1. Tilt the cab. ⇒  P. 12-6
If the vehicle is a Crew-cab model, perform the procedure to reach to the engine access opening beneath the assistant driver's seat. ⇒  P. 12-5
2. Inspect the V-belt for proper tension by pressing it with your palm in either of the places marked with arrows.
3. If the belt is excessively loose, have the vehicle inspected by an authorized dealer.
4. Also, check the belts for damage.

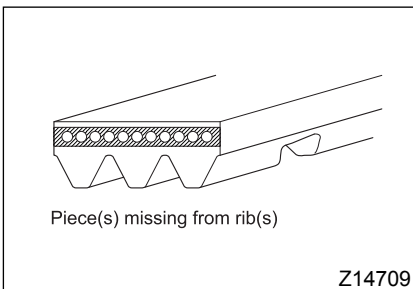

If a belt is cracked or otherwise damaged, have it replaced as soon as possible. Belt replacement requires component disassembly. Please contact an authorized dealer to have the belt replaced.

STEERING WHEEL – INSPECTION

⚠ WARNING

- The steering wheel is a safety-critical part of the vehicle. If an inspection reveals any abnormality, contact an authorized dealer and have the abnormality corrected before you again drive the vehicle. Driving the vehicle without correcting the abnormality could result in a serious accident.
- Perform these inspections in a safe place that provides good visibility all around. During these inspections, be sufficiently aware of the surrounding traffic conditions.

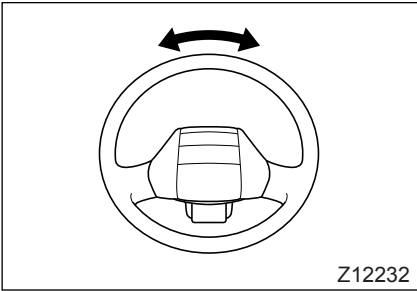

1 Steering wheel play

Inspection intervals	At the time of pre-operational check and every 32,000 km (20,000 miles)
----------------------	---

NOTE:
Be sure to check the steering wheel play both with the engine running and with the engine turned off.

Gently turn the steering wheel from its straight ahead (neutral) position clockwise until you first feel resistance. Return the steering wheel to its straight ahead neutral position. Next, turn the wheel counter-clockwise until you first feel resistance. The distance between the two points of resistance is known as the steering wheel play.

Check the steering wheel play both with the engine running and with the engine turned off. If it is out of specification either with the engine running or with the engine turned off, contact your nearest authorized dealer.

Steering wheel play (on the periphery of steering wheel)	When engine is turned off	10 to 20 mm (0.39 to 0.79 in.)
	When engine is idling	5 to 50 mm (0.20 to 1.97 in.)

2 Steering wheel looseness

Inspection intervals	32,000 km (20,000 miles)
----------------------	--------------------------

1. Try moving the steering wheel up and down and also right and left to check for excessive looseness.
2. If anything abnormal is found, contact an authorized dealer.

NOTE:

Make sure the lock lever that is used for steering wheel adjustment is securely locked.

3 Steering wheel operation

Inspection intervals	At the time of pre-operational check and every 32,000 km (20,000 miles)
----------------------	---

1. While driving slowly, make sure that the steering wheel does not shake and the vehicle does not pull to one side. Also check for excessive operating resistance and unsmooth return to the neutral position.
2. If any abnormal condition is encountered during the above check, call an authorized dealer for inspection.

SERVICE BRAKES – INSPECTION



WARNING

The service brakes are safety-critical parts of the vehicle. If an inspection reveals any abnormality, contact an authorized dealer and have the abnormality corrected before you again drive the vehicle. Driving the vehicle without correcting the abnormality could result in a serious accident.

Inspection intervals	At the time of pre-operational check
----------------------	--------------------------------------

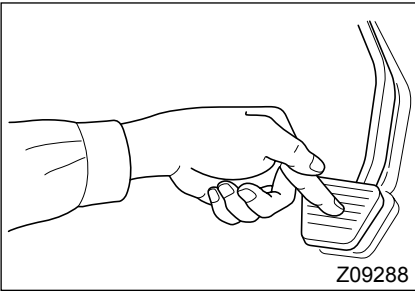

1 Brake pedal play

1. With the engine stopped, turn the starter switch to the "ON" position.
2. Depress the brake pedal several times until the pedal feels stiffer than normal.
3. Measure the distance over which the brake pedal moves when the center of the pedal pad is pressed with light finger force to the point where resistance is felt (brake pedal play). Check whether the distance is within specification.

Brake pedal play (at center of pedal pad)	0.1 to 3 mm (0.0039 to 0.12 in.)
--	-------------------------------------

4. If the brake pedal play is not as specified, have the pedal inspected and adjusted by an authorized dealer.

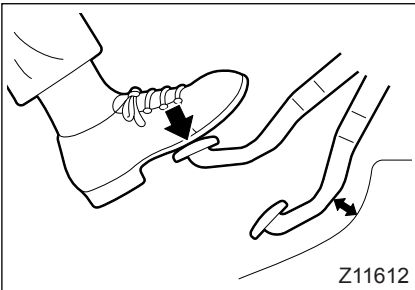

2 Brake pedal stroke

- Start the engine and allow it to idle.
- Fully depress the brake pedal. Check whether the distance between the fully depressed pedal and the floor is within specification.

Fully depressed brake pedal to floor clearance	10 mm (0.39 in.) or more
--	--------------------------

- If the pedal-to-floor clearance is insufficient or the pedal feels spongy when depressed, brake fluid leakage or presence of air in the brake hydraulic system may be a cause. Have the brake system inspected by an authorized dealer if the above conditions are detected.

3 Braking performance

Perform braking tests in a safe place. After checking that warning lamp **BRAKE** or **LOW VACUUM** is not illuminated, drive the vehicle at a low speed to make sure that braking power is sufficient and even. If braking seems in any way abnormal, operating the vehicle could be dangerous. Ask an authorized dealer for a more thorough inspection.

⚠ WARNING

Perform brake tests in a safe place that provides good visibility all around. During the tests, be aware of the surrounding traffic conditions.

PARKING BRAKE – INSPECTION AND ADJUSTMENT

WARNING

Inspect the parking brake, and if there is a problem, repair it before driving the vehicle. Driving the vehicle as it is could lead to a severe accident. If you find a problem, have it inspected by an authorized dealer.

Inspection intervals	At the time of pre-operational check
----------------------	--------------------------------------

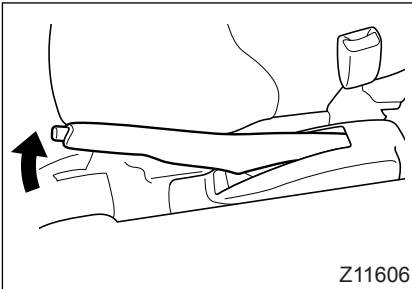

1 Parking brake lever stroke check

1. Depress the brake pedal firmly so that the vehicle cannot move.
2. Starting with the parking brake lever in the fully released position, pull the parking brake lever with a force of 294 N (66 lbs., 30 kgf) until it stops moving. Check whether the lever stroke (the distance moved by the lever) is within specification. If the stroke is out of specification, have the vehicle inspected by an authorized dealer.

Parking brake lever stroke	7 to 9 notches
----------------------------	----------------

3. Make sure the parking brake lever locks securely in the pulled position.

2 Braking performance

Stop the vehicle on a dry downgrade, set the parking brake and check to see if the parking brake can hold the vehicle. If an appropriate downgrade is not available, drive the vehicle at 8 km/h (5 mph) and activate the parking brake to make sure that it exhibits satisfactory braking action.

If parking brake performance is in any way abnormal, vehicle operation could be dangerous. Contact an authorized dealer.

WARNING

Perform brake tests in safe place that provides good visibility all around. During the tests, be sufficiently aware of the surrounding traffic conditions.

TIRES – INSPECTION

Inspection intervals	At the time of pre-operational check
----------------------	--------------------------------------

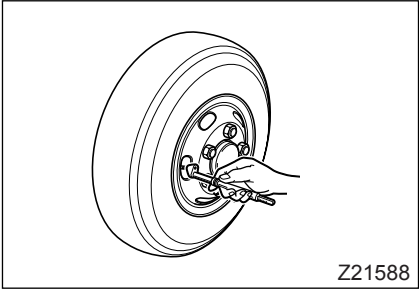

1 Inflation pressure check

- Use an air pressure gauge to check for proper tire inflation pressure. If the pressure is incorrect, adjust it to the indicated standard pressure.

- Tire pressure should be checked and adjusted before driving when the tires are still cool. Make sure that the tire air valve caps are securely fitted.

Standard inflation pressure

Model	Tire size	Inflation pressure kPa (psi, kgf/cm ²)
FEC5	LT215/85R16-10PR (Load Range E)	550 (80, 5.5)
FEC7 FEC9 FECX	215/75R17.5 124/ 123L (Load Range F)	690 (100, 7.0)
FG	LT235/85R16-10PR (Load Range E)	550 (80, 5.5)

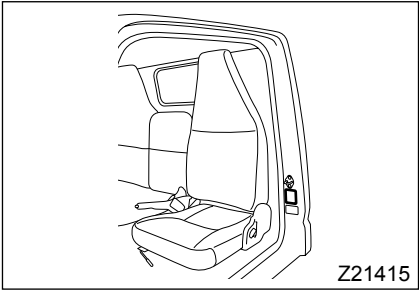

- There is a plate affixed to the driver's door pillar indicating standard inflation pressure.

 **WARNING**

- Excessively low or high tire pressures not only give a poor ride but also could cause cargo to be damaged. Under-inflated or over-inflated tires are also very dangerous and can be easily damaged. Moreover, if the pressure is too low, tires could over-heat and burst.
- Both the inner and outer tires on dual wheels should be inflated to the same pressure.
- Tires should be handled with care due to their high internal air pressure.

 **CAUTION**

- Your vehicle's tires will heat up during use, causing an increase in air pressure. This is normal; do not release air from the tires when they are hot.
Always check the tire pressures before driving, when the tires are cold.
- Pay close attention to the air pressure in new tires. New tires tend to stretch slightly as they settle, which can cause a decrease in air pressure.
- Never fail to install tire valve caps after checking or adjusting the air pressure.
Unless the valve caps are replaced, foreign matter may interfere with the valves and cause air to leak out.

NOTE:

- *The tire inflation pressures will be higher just after vehicle operation than before vehicle operation. The increases in pressure are not abnormal; they occur because the air in the tires expands as the tires get hot while the vehicle is moving. Do not release air from the tires at this time. The pressures will return to normal as the tires cool down.*
- *The pressure drops naturally as time passes. You should check the tire pressure using an air gauge.*

2 Inspecting tread depth

Inspect the entire circumference of each tire to make sure that the remaining depth of the tread pattern on the part that contacts the road surface is sufficient.

Tread groove depth limit	1.6 mm (0.06 in.)
--------------------------	-------------------

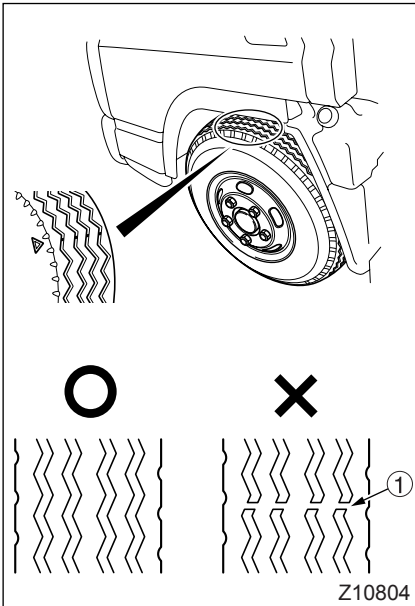

When the tread wears down, wear indicators ① (interrupted sections of the grooves) appear across the tire at the locations corresponding to the ▲ marks.

Replace the tire as soon as the wear indicators show up as continued use is dangerous.

⇒ P. 12-75

! WARNING

If the remaining tread is too shallow, the tires tend to skid and chances of “hydroplaning” during high speed driving increase. Worn tires should be replaced as soon as possible.

NOTE:

Hydroplaning can occur when driving on wet roads at high speeds. When a vehicle hydroplanes, tires ride on top of a film of water, causing the driver to lose control of both steering and braking.

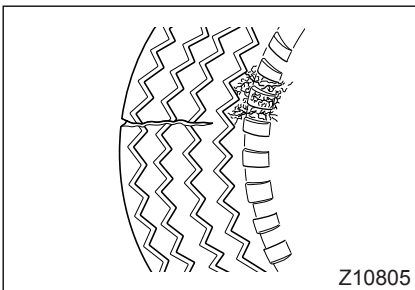

3 Inspecting for cracks, damage, and objects embedded in tread

- Inspect both the tread and the sides of each tire for cracks, damage, and excessive or unusual wear. Also inspect for metal pieces, nails, and stones that might be embedded in the tread or caught between the tires of dual wheels.
- Touch the tire by hand to inspect whether rubber has softened by adhesion of oil, chemicals, etc. Also inspect the tire for expansion or deformation.

Inspect the spare tire at the same time.

! WARNING

Severely damaged or worn tires are susceptible to puncture during use and should be replaced as soon as possible.

TIRE REPLACEMENT

1 Preparing to replace a tire

- Park the vehicle on a flat, hard surface. Pull the parking brake all the way on. Place the gearshift lever in the “P” position.
- Be sure to stop the engine.
- If you get a flat tire while on the road and need to change it on the spot, pull up your vehicle in a safe place where it will not block traffic, and activate your hazard warning lamps to flash and use a red or white flag or cloth to give warning to passing vehicles.
- Have all passengers get out of the vehicle.
- Remove any heavy cargo from the vehicle.
- Block the tire diagonally opposite to the tire to be replaced with a chock.

Example:

Block the left front tire if the right rear tire is to be replaced.

- Obtain a replacement tire.

NOTE:

- *Your vehicle is not provided with a replacement tire as standard equipment.*
- *Applicable tires are as follows.*

Model	Tire size
FEC5	LT215/85R16-10PR (Load Range E)
FEC7 FEC9 FECX	215/75R17.5 124/123L (Load Range F)
FG	LT235/85R16-10PR (Load Range E)

CAUTION

Low-rolling resistance (LRR) tires minimize wasted energy as a tire rolls, thereby decreasing rolling effort and improving fuel efficiency. If tire replacement is necessary, replacement tires must meet or exceed the rolling resistance of the originally installed tires in order to maintain compliance with greenhouse gas and full efficiency regulations (GHG14). Contact your tire manufacturer/supplier to determine the rolling resistance of the originally installed tires. Visit www.epa.gov/smartway for additional information and resources.

2 Removing the wheel

2.1 Front axle jacking points

<FE>

Bottom surface of the leaf spring at the rear of tie rod.

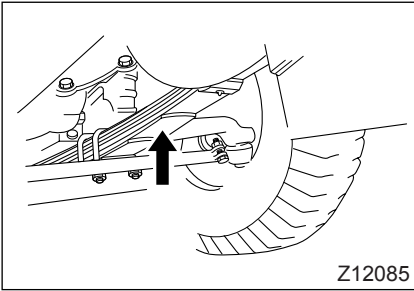

<FG>

Jack support ① under the front axle.

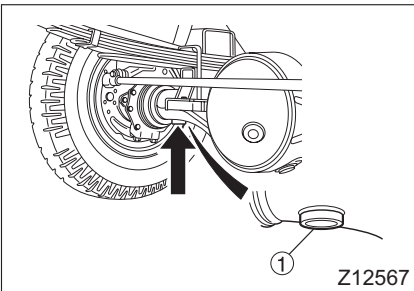

2.2 Rear axle jacking point

<FE>

Bottom surface of the axle housing (beside leaf spring U-bolt mounting).

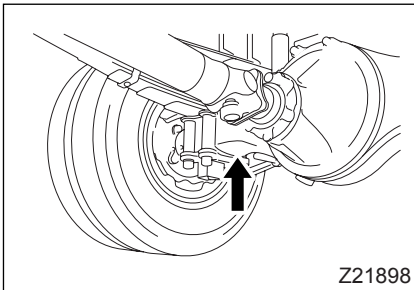

<FG>

Bottom surface of the axle housing.

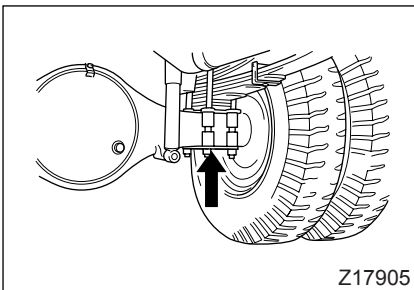

2.3 How to remove a wheel

WARNING

- Raise the vehicle with the jack on a flat, hard area. Doing so on a slope or soft surface could cause the jack to lean over or slip, and could lead to a serious accident.
- Before raising the vehicle with the jack, apply the parking brake lever properly and place chocks around the wheels. Failure to do so could cause the vehicle to move while it is jacked up, which could cause a serious accident.
- Check that there is no oil on the jack or jacking point. Failure to do so may cause the jack to slip, which could cause a serious accident. If there is any oil on them, wipe them clean.
- Do not use two or more jacks at the same time. Doing so could cause a jack to come loose, which could cause a serious accident.
- After raising the vehicle slightly, confirm that the jack is securely in position. If the jack slips out of position with the vehicle fully raised, the vehicle could fall and cause a serious injury.
- Apply the jack only to designated jacking points. Applying the jack elsewhere could damage the vehicle and cause the jack to slip out of position.
- Never rock or climb below the vehicle when it is jacked up since movement of the jack could result in a serious injury or in damage to the vehicle. Never start the engine when the vehicle is jacked up.
- It is dangerous to leave the vehicle jacked up for long periods. If you need to raise the vehicle for an extended period, support it with suitable stands placed against the bottom surfaces of the frame.
- Never try to remove the outside wheel of the rear dual wheel by driving only the inside wheel over a wooden block or the like. This may lead to a serious accident.

! CAUTION

Do not jack up the vehicle more than necessary. Doing so could damage the jack.

- When replacing tires on the road or similar areas, stop the vehicle in a safe location, and use the hazard warning lamps and reflective triangle.
 - Passengers in the vehicle should get out.
1. Securely apply the parking brake. Apply chocks to the front and back (as seen from the side of the vehicle) of the wheel diagonally opposite the one that is to be jacked up.
 2. Position the jack under the jacking point of the vehicle and raise the vehicle to a point at which the tire is still touching the ground.

NOTE:

Socket wrenches for use in jacking up the vehicle or loosening/tightening the wheel nuts are not included in the onboard tools.

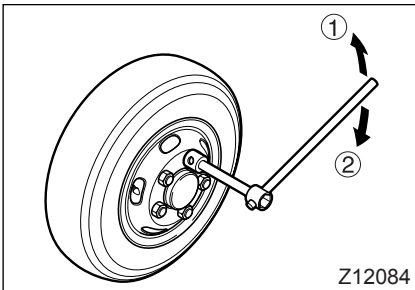

3. Slightly loosen the wheel nuts by turning them in the illustrated direction. Do not remove the nuts.

- ① For right-hand wheel
- ② For left-hand wheel

NOTE:

The wheel nuts on the right-hand wheel are marked with "R" and have right-hand threads. Those on the left-hand wheel are marked with "L" and have left-hand threads.

! WARNING

- Fit the socket wrench securely on the wheel nut. If fitted improperly, the wrench will slip off the nut, and could cause injury.
- Do not loosen the wheel nuts too much or you could damage the threads. If the threads are damaged, replace the wheel bolts and wheel nuts as a set.

4. Jack up the vehicle until the tire is just clear of the ground.
5. Remove the wheel nuts and then the tire.

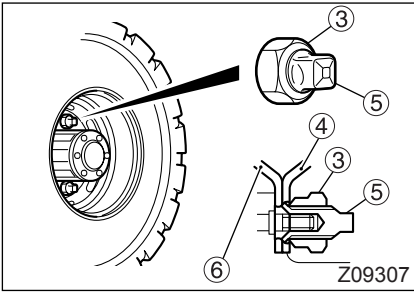

6. To remove the tires of a rear dual-wheel, first loosen the outer wheel nuts ③ and remove the outer tire ④; then lower the jack, loosen inner wheel nuts ⑤ and jack up the vehicle again to remove inner tire ⑥.

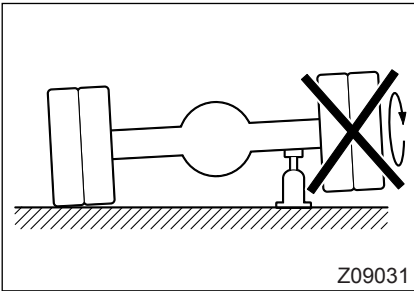

⚠ WARNING

- Do not rotate or spin the jacked-up wheel if the vehicle has a limited-slip differential. Power would be transmitted to the wheel in contact with the ground. As a result, the vehicle could move and cause a serious accident.
- When removing wheels, be careful not to damage the wheel bolts and the threads of the inner wheel nuts. If the threads are damaged, replace the wheel bolts and wheel nuts as a set.

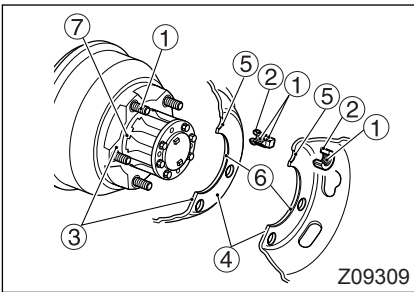

3 Mounting the tire

1. Clean the following sections before mounting the wheel. If they are dirty, the wheel nuts could become loose during driving.
- ① Threads on wheel bolts and nuts
 - ② Spherical surface of wheel nuts
 - ③ Disc wheel mounting surface
 - ④ Disc wheel mating surface
 - ⑤ Wheel nut contact surface on disc wheel
 - ⑥ Disc wheel inside surface
 - ⑦ Guide sections on hub

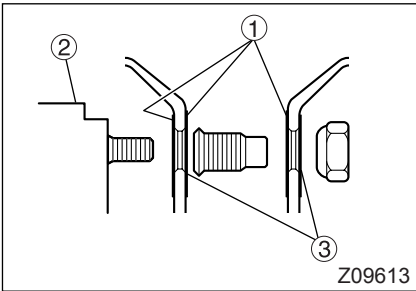

! WARNING

- When tightening the wheel nuts, do not apply grease or engine oil to the wheel bolt threads or wheel nut base. Accidentally doing so causes excessive tightening force and causes stretching or damage to the wheel bolts, or deformation to the disc wheel nut seating surface, and could cause wheels to come loose.
- If the above items are dirty, the nuts will become loose during vehicle operation. If wheel bolt or nut threads are damaged or the disc wheel is cracked or otherwise damaged, replace the wheel with a new genuine part. A damaged wheel could come loose and cause a serious accident while the vehicle is in motion.
- Do not paint disc wheel mounting surfaces ①, dual wheel mating surfaces, wheel nut seating surfaces ③, and wheel hub ② mounting surfaces as resulting thicker paint film could cause the wheel nuts to come loose. If there is additional paint, remove the paint and clean the surface with a wire brush or similar tool.
- Be sure to use the specified types of tires and disc wheels. Mixing cross-ply and radial-ply tires adversely affects steering control. Never mix different tire types. In addition, mixed use of different types of tires can produce the following undesirable effects:
 - The ABS system cannot work as intended.
 - The speedometer indicates a different speed from the actual vehicle speed.
 - The DUONIC® system (transmission) cannot change gear at the optimum timing, causing excessive fuel consumption.
 - The tires may touch or rub the frame and steering components.

- If a wheel bolt is damaged, replace all the wheel bolts and wheel nuts of that wheel.
- When the tires or the disc wheels have been replaced or been reassembled, perform the wheel balance adjustment.

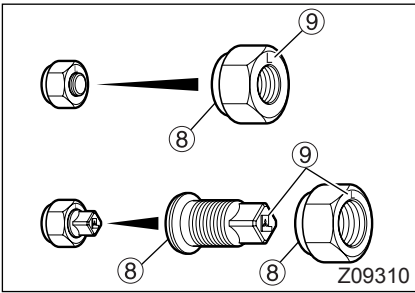

2. Mount the wheel so that the wheel bolts line up with the bolt holes in the disc wheel. Then, tighten the wheel nuts to hold the disc wheel in position. If the wheel nut has a spherical end ⑧, place the spherical end toward the disc wheel.

! WARNING

When mounting wheels, take care not to damage the threads of the wheel bolts and inner wheel nuts. If the threads are damaged, replace the wheel bolts and wheel nuts as a set.

NOTE:

- The wheel bolts and nuts on the right-hand wheels have right-hand threads, and those on the left-hand wheels have left-hand threads. The bolts and nuts have stamped marks ⑨ for easy identification; an “R” mark for right-hand wheels and an “L” mark for left-hand wheels.
- Wheel nuts ⑩, outer wheel nuts ⑪ and inner wheel nuts ⑫ are marked with “ST” or “S-A”. The “ST” mark indicates that these fasteners are for steel wheels and the “S-A” mark that they are for both steel and aluminum wheels.

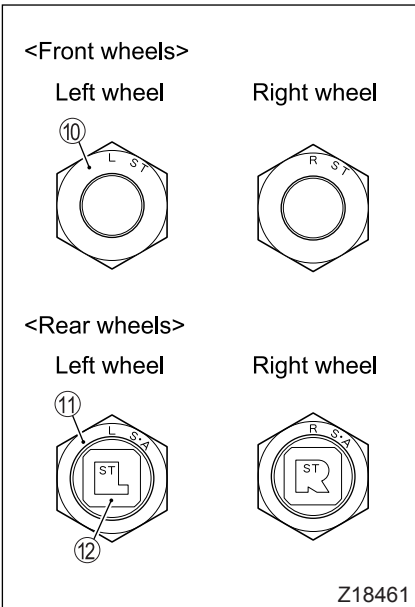

3. Lower the vehicle until the tire makes contact gently with the ground.

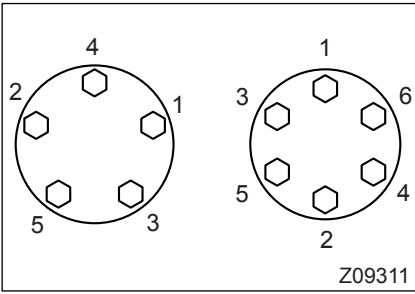

4. Tighten the wheel nuts in the order shown in the illustration, repeating the tightening cycle 2 to 3 times. Finally, tighten the nuts to the specified torque.

Tightening torque	440 to 540 N·m (325 to 398 ft.lbs., 45 to 55 kgf·m)
-------------------	--

⚠ WARNING

- Fit the socket wrench securely on the wheel nut. If fitted improperly, the wrench will slip off the nut, and could cause injury.
- Do not jump or jerk on the wrench handle when tightening the nut by using your own weight. Doing so can overtighten the nut. Overtightening the nuts could overstrain the bolts or deform the disc wheel's surface.
- The wheel nuts must be tightened to the specified torque. If the nuts are tightened loosely or too tight, parts may be damaged and wheels may come off. This can damage the vehicle and cause physical injury.

⚠ CAUTION

Wheel nuts should be tightened with a torque wrench, using a socket wrench and wrench handle should be done in emergencies only. Use a torque wrench to check the torque as soon as possible after using a socket wrench and wrench handle to tighten the wheel nuts.

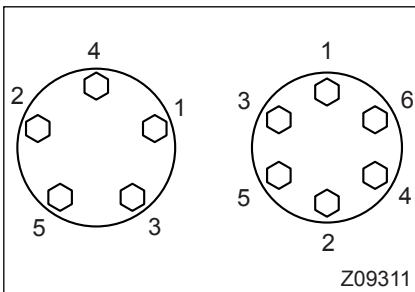

5. Mount the dual rear wheels as described below.

⚠ WARNING

When replacing an outer wheel of a dual rear wheel, be sure to retighten the inner wheel nuts before tightening the outer wheel nuts.

NOTE:
When installing dual wheels, position the air valve of the outer wheel diagonally opposite that of the inner wheel.

Mount the inner wheel, then jack up the vehicle again. Set the outer wheel so that the wheel bolts are located in the centers of the disc wheel's bolt holes, then tighten the wheel nuts just enough to eliminate looseness.

Lower the vehicle, then tighten the wheel nuts in the illustrated sequence. Work through the sequence two or three times, finally tightening each wheel nut to the specified torque.

6. If only the outer wheel of dual wheels is replaced, retighten the inner wheel nuts to the specified torque before mounting the outer wheel.

 **WARNING**

As the vehicle is driven after a wheel has been replaced, the wheel nuts can loosen up during the early stages of driving due to "wear-in." Therefore, it is necessary to retighten the wheel nuts to the specified torque after driving 50 to 100 km (30 to 60 miles). Thereafter, retighten the nuts at regular intervals.

NOTE:

- *New tires can become warm and wear out easily while driving, so mount them on the front two wheels where the load is less. Break in new tires by driving 200 km (125 miles) or more at 60 km/h (37 mph) or less, and check the air pressure.*
- *If there is a difference in external diameters of the rear dual wheels due to wear, use wheels that have a difference in external diameter of 6 mm or less between the inner and outer wheel, and mount the wheel with the smaller external diameter on the inside.*

**WHEELS AND WHEEL NUTS –
INSPECTION AND RETIGHTENING**

 **WARNING**

After changing a tire, the wheel nuts can loosen up during the initial stages of driving due to “wear-in.” Therefore, retighten the wheel nuts to specification after you have driven 50 to 100 km (30 to 60 miles).

- Using a torque wrench, check for loose wheel nuts and tighten as necessary.
- Check that there is no damage, dents, cracks, rust or other abnormalities on the wheel (rim, disc wheel). Check for cracks, damage and stepped-type wear particularly around the disc wheel bolt holes and design holes.
Replace any abnormal wheels with genuine new items.

 **CAUTION**

Be sure to use a torque wrench to tighten the wheel nuts.

Wheel nut tightening torque	440 to 540 N·m (325 to 398 ft.lbs., 45 to 55 kgf·m)
-----------------------------	--

If the wheel nuts continue to come loose after tightening them, have them inspected by an authorized dealer.

 **WARNING**

- A loose wheel nut could cause parts damage, and result in a tire falling off. This can damage the vehicle and cause physical injury. Be sure to check the wheel nuts regularly.
- Fit the socket wrench securely on the wheel nut. If fitted improperly, the wrench will slip off the nut, and could cause injury.

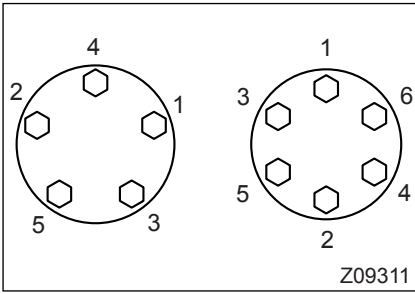

- **Single tire**

Tighten the wheel nuts to the specified torque. Follow the diagonal tightening sequence indicated in the figure.

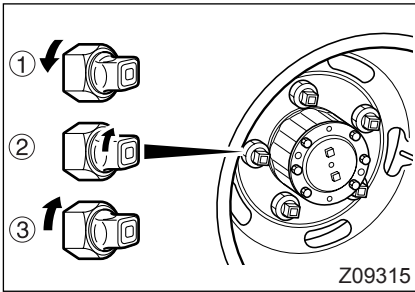

- **Dual wheels**

Retighten the wheel nuts using the following procedure.

- ① Loosen the outer wheel nuts as follows:
5-bolt type: Loosen the nuts numbered 1 – 2 – 3 or 4 – 5 in the figure in this order.
6-bolt type: Loosen the nuts numbered 1 – 4 – 5 or 2 – 3 – 6 in the figure in this order.
- ② Tighten the inner wheel nuts corresponding to the loosened outer wheel nuts to the specified torque.
- ③ Tighten the loosened outer wheel nuts to the specified torque.
- ④ Perform the above steps ① through ③ for the remaining outer wheel nuts and inner wheel nuts.

⚠ WARNING

In the case of dual wheels, one often retightens outer wheel nuts while forgetting to retighten inner wheel nuts. Always follow the above procedure to tighten all the nuts.

NOTE:

The wheel bolts and nuts on the right-hand wheels have right-hand threads, and those on the left-hand wheels have left-hand threads.

The bolts and nuts have stamped marks for easy identification; an “R” mark for right-hand wheels and an “L” mark for left-hand wheels.

TIRE ROTATION

Same tread pattern on all tires

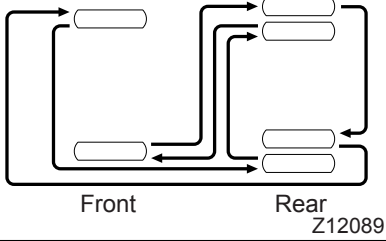

The amount of wear on a tire depends on the load and its position on the vehicle. To equalize wear and extend life as much as possible, rotate the tires at regular intervals. Depending on the road and driving conditions, it may be necessary for the tire rotation intervals to be shortened.

Different tread patterns on front and rear tires

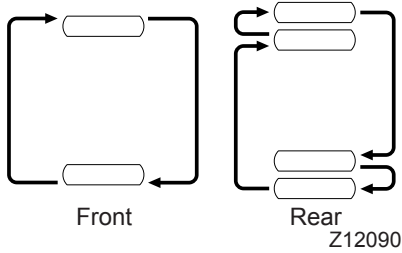

- Use a tire of the same type on a single axle. If different type tires are mounted on an axle, the vehicle tends to pull to one side during braking, and could cause you to lose directional control of the vehicle.
- Applicable tires are as follows.

Model	Tire size
FEC5	LT215/85R16-10PR (Load Range E)
FEC7 FEC9 FECX	215/75R17.5 124/123L (Load Range F)
FG	LT235/85R16-10PR (Load Range E)

WARNING

- Be sure to use the specified type of tires and disc wheels. Mixing cross-ply and radial-ply tires adversely affects steering control. Never mix different tire types. In addition, mixed use of different types of tires can produce the following undesirable effects:
 - The ABS system cannot work as intended.
 - The difference in the speed indicated by the speedometer and the actual speed of the vehicle increases.
 - The DUONIC[®] system (transmission) cannot change gears at the optimum timing, and consumes more fuel.
 - The tires may come in contact with the frame or steering components.
- As the vehicle is driven after a wheel has been replaced, the wheel nuts can loosen up during the early stages of driving due to “wear-in”. Therefore, it is necessary to retighten the wheel nuts to the specified torque after driving 50 to 100 km (30 to 60 miles). Thereafter, retighten the nuts at regular intervals.
- If as a result of tire rotation, an additionally painted face of the disc wheel mounting face ① becomes the mounting face for the mating part (wheel hub ② and disc wheel), remove the paint from the mounting face of the disc wheel and the seating face ③ of the wheel nut, clean these surfaces with a wire brush or the like, and then install the wheel. If you use the mounting faces without removing the paint, the wheel nuts are likely to become loose because the paint film is thick.

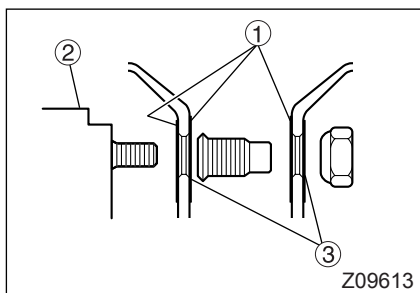

CAUTION

If using different tread patterns on the front and rear wheels, select tires with a ribbed tread for the front wheels and tires with a traction-type tread for the rear wheels.

NOTE:

- New tires can become warm and wear out easily while driving, so mount them on the front two wheels where the load is less. Break in new tires by driving 200 km (125 miles) or more at 60 km/h (37 mph) or less, and check the air pressure.
- If there is a difference in external diameters of the rear dual wheels due to wear, use wheels that have a difference in external diameter of 6 mm or less between the inner and outer wheel, and mount the wheel with the smaller external diameter on the inside.

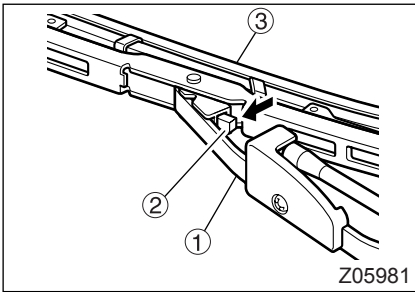

WIPER BLADE – REPLACEMENT

1 Replacing wiper blade

1. Raise the wiper arm ①, and then push clip spring ② in the direction of the arrow (see figure).

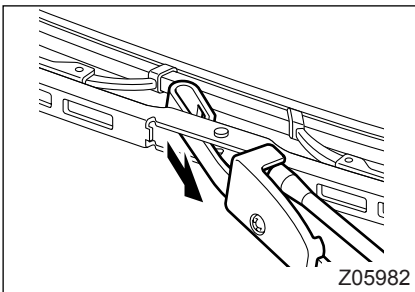

2. With the clip spring kept in the pushed position, press wiper ③ toward the wiper arm.

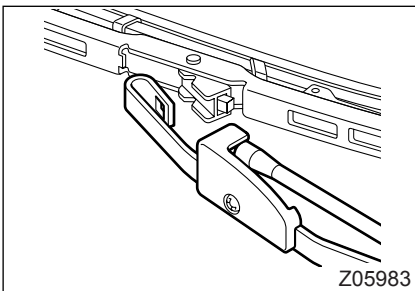

3. The wiper blade will come off the wiper arm. Install a new blade in the reverse order of removal. Use a genuine replacement part.

! CAUTION

Do not bring the wiper arms back into position or operate the wipers without wiper blades, as this could scratch the windshield.

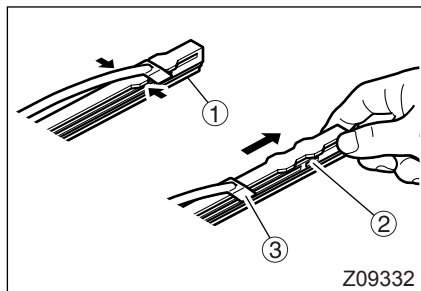

2 Replacing rubber part only

1. Raise the wiper arm.
Pinch both sides (indicated by arrows) of the rubber part ① with your fingers and then pull the rubber part so that the claws ③ are unhooked from the grooves ② in the rubber part.
2. Slide out the rubber part.
3. Replace the old rubber part with a new genuine rubber part of wiper blade.
To install, reverse the removal procedure. Make sure that the claws fit into the grooves in the rubber part.

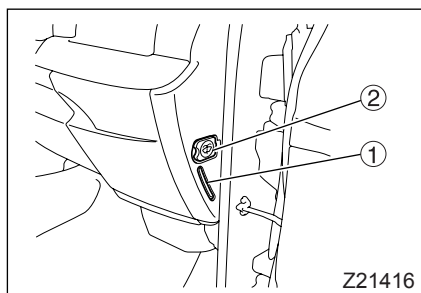

WINDSHIELD WASHER – FLUID LEVEL INSPECTION AND REFILLING

1 Fluid level inspection

Inspect the washer fluid level through the inspection window ①.

When the level has dropped to the lower part of the window or is not visible at all, refill the tank with washer fluid.

2 Refilling

1. Open the assistant driver's door.
2. Open the windshield washer tank cap ② and pour in a mixture of windshield washer fluid and tap water until the level reaches the top of the check window.
3. Close the cap tightly after refilling.

Windshield washer fluid quantity	Approx. 3.0 liters (3.2 qts)
----------------------------------	------------------------------

! CAUTION

- Substituting soapy water for washer fluid could result in clogged washer nozzles or spots on painted surfaces.
- Operating the washer continuously for more than 20 seconds or when there is no fluid in the reservoir could burn out the washer motor.

NOTE:

When it is very cold, the ratio of windshield washer fluid to water should be increased in order to prevent the mixture from freezing up.

BATTERY – INSPECTION

Inspection intervals

At the time of pre-operational check

WARNING

- The battery generates flammable hydrogen gas and should be kept away from open flame and spark.
- When removing the battery, always disconnect the negative (–) terminal first and reconnect it last. A spark can occur if a tool touches the positive (+) terminal and frame with the negative (–) terminal connected.
- When handling the battery, always wear safety goggles and rubber gloves. Failure to do so may cause loss of eyesight or burns.
- Perform all battery inspections with the engine turned off.

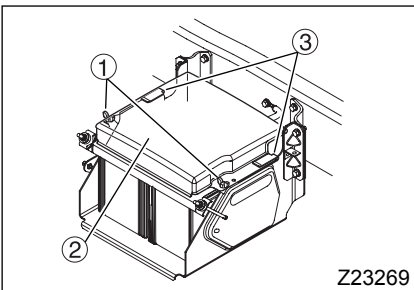

1 Removal and installation of the battery cover

1. Remove the two wing bolts ①. Pull the cover ② toward you to remove it from the stoppers ③.
2. To install the cover, follow the removal steps in reverse. After installing the cover, make sure it is securely retained.

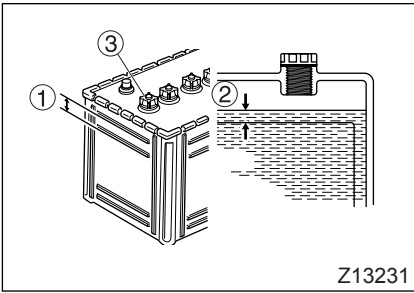

2 Inspecting the battery

- The battery fluid level should be between the “UPPER LEVEL” line and “LOWER LEVEL” line ① marked on the battery case. If the battery fluid level is low, add electrolyte or distilled water to the “UPPER” level line.
- If your battery has no level line markers, the fluid should be ② 10 to 15 mm above the tops of the electrode plates.

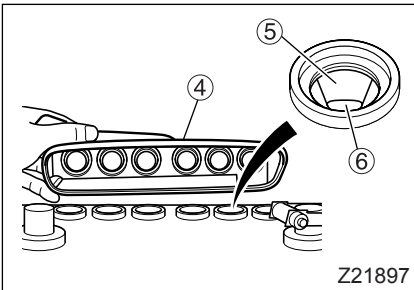

- If the side of the battery case is not in your direct view due to equipment or other things on the vehicle body, perform the following:
 - Remove the battery’s cap ③.
 - Check the battery fluid level using an appropriate mirror like a hand mirror ④.
 - Check whether the battery fluid ⑥ comes up to the bottom ⑤ of the sleeve of each filler hole.



DANGER

BATTERY FLUID IS DILUTED SULFURIC ACID AND CAN HARM MOST THINGS IT TOUCHES, INCLUDING HUMAN SKIN AND CLOTHING. IF YOU GET IT ON YOUR SKIN OR CLOTHING, FLUSH IT OFF WITH SOAP AND WATER. IF YOU ACCIDENTALLY GET BATTERY FLUID IN YOUR EYES, WASH YOUR EYES WITH LOTS OF CLEAN WATER THEN PROMPTLY SEE AN EYE DOCTOR FOR TREATMENT.



WARNING

Do not use the battery with the fluid below the “LOWER” level line. The battery would deteriorate rapidly, and it could overheat or explode.

 **CAUTION**

- Whenever battery fluid has been added, either charge the battery or run the vehicle for a while. It is especially important in cold weather as the battery can freeze up and be damaged.
- Do not add so much fluid that the fluid in the battery rises above the “UPPER LEVEL” line. With the fluid above the “UPPER LEVEL”, fluid could leak out and corrode the battery terminals.

3 Cleaning the terminals

Use warm water and sodium bicarbonate (baking soda) to remove any white powder caused by corrosion.

If a terminal is heavily corroded, remove the battery cable and clean the terminal with a wire brush or sandpaper.

After cleaning, apply a thin coat of grease to the terminals.

NOTE:

Removing the battery terminal cables could erase the memory of devices installed on the vehicle.

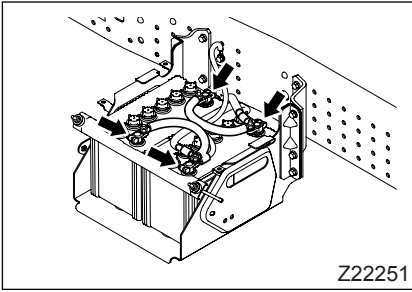

Z22251

4 Battery removal and installation

1. Disconnect the battery cables (each indicated by an arrow ➡ in the illustration) from the battery terminals.

⚠ WARNING

When disconnecting the battery cables, disconnect the (-) cable first. When connecting the battery cables, connect the (-) cable last. If you accidentally touched the (+) terminal and the vehicle body with a tool with the (-) cable connected to the battery, a dangerous short circuit could occur.

⚠ CAUTION

The BlueTec® exhaust gas aftertreatment continues to work for 2 minutes even after the starter switch is turned to “LOCK”. Wait for at least 2 minutes after shutting off the engine before disconnecting the battery.

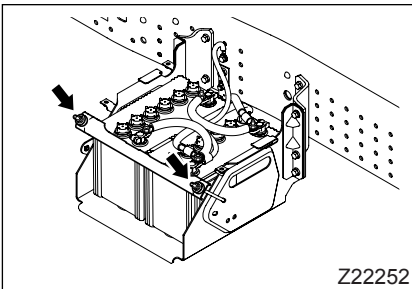

Z22252

2. Remove the battery support mounting nuts (each indicated by an arrow ➡ in the illustration).
3. Remove the battery support ①, then remove the battery.
4. Install the battery by performing these steps in reverse. After installing the battery, make sure it is securely retained.

⚠ WARNING

Be sure to observe the following instructions when storing a battery.

- Select a storage place where the battery fluid will not freeze.
- The storage place must be free of any heat source and be well ventilated.
- The battery must be kept out of reach of children.
- The battery must be placed with the terminals facing upward. Do not place the battery on its side. Doing so could cause battery fluid leakage and a fire.

 **CAUTION**

- Install the battery securely in position. If it is left loose, shocks and vibrations from road surface could damage the battery case and electrode plates, shortening battery life.
- When charging the battery, remove it from the vehicle. Gases generated while charging could ignite and explode.

AIR FILTERS – CLEANING

Remove and clean the air filters (heater or air conditioner filters) with water or compressed air to eliminate dust and dirt at regular intervals (6 months or so).

Clogged filters may cause inefficient heating or air-conditioning, and even blower motor malfunction.

 **WARNING**

When cleaning the air filters, wear a dust mask to avoid inhaling dust. Dust inhalation can have adverse health effects.

 **CAUTION**

Clean the air filters at shorter intervals if your vehicle is used frequently in dusty areas.

1 Outside air filter

Disassembly is necessary before the outside air filter can be cleaned. Have an authorized dealer perform the job.

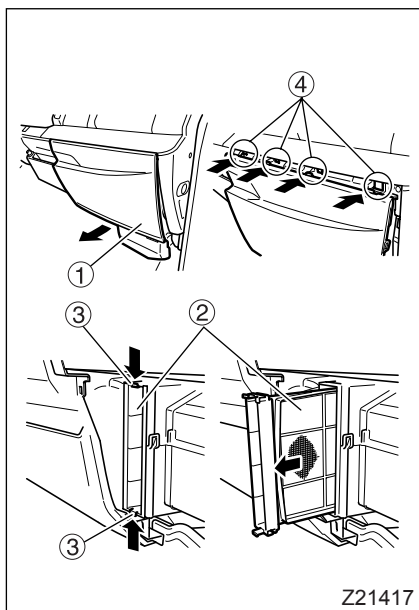

2 Dashboard air filter

1. Remove the lower panel ① in front of the assistant driver's seat.
2. Pull out the air filter ② while pushing both the tabs ③ inward on the filter.
3. Reinstall the lower panel by first aligning the claws ④ with the corresponding slots and then pushing the panel forward.

CLEANING YOUR VEHICLE

1 Exterior cleaning

1.1 Washing

Using a hose, wash the mud and dirt off the body surfaces. Wash not only the surfaces around the cab, but also the wheel housings and the underside of the chassis.

Especially after you have driven in a coastal area or on salted road in the winter, your vehicle should be given a thorough washing. Also try to wax the body surfaces once a month.

You must wash the vehicle whenever it has experienced any of the following:

- Been driven on coastal roads
- Been driven on roads where road chemicals have been applied
- Become contaminated by coal tar, smoke, soot, powder dust, iron powder, lime powder, sap, bird droppings, etc.
- Adhesion of dust and/or mud

! WARNING

- When washing the underside of the vehicle, be careful not to hurt yourself on the edges of panels and other parts.
- After driving through a puddle or after washing the vehicle, check that the brakes operate before driving again. Water entering various components of the brake system could severely affect brake performance and cause an unexpected accident. If this happens, slow down while paying attention to other nearby vehicles, and depress the brake pedal lightly several times to dry out the wet brakes until brake performance is restored.

! CAUTION

- Never apply rubbing compound to glass since it leaves scratches.
- Wash the vehicle with luke-warm or cold water. Do not use very hot water.
- Avoid leaving the vehicle in direct sunlight.
- Do not use concentrated soap or synthetic detergents.
- Rinse the detergent off with water. Do not leave the detergent on the paintwork since it could discolor the paint.
- Cleaning plastic parts with thinner or gasoline could result in cracking or discoloration.
- In cold weather, the lock cylinders and rubber parts of the door sometimes freeze, making it hard to open the door. After washing, remove moisture on and around the doors.
- When washing the vehicle in cold weather, be careful not to directly spray water over the lock cylinder in the fuel tank cap (vehicles with a key-locked fuel tank cap). If the lock cylinder is wet with water, the fuel tank cap may become impossible to open. It is also important to thoroughly wipe off water around the fuel tank cap after washing the vehicle.

- When driving on roads in coastal areas or where antifreeze or snow melting agents have been applied to the roads, wash the vehicle thoroughly with special attention to the wheel wells and underside of the chassis. Road chemicals left on the vehicle cause rust to form quicker, and cause damage and other abnormalities to components on the underside of the chassis. To use the vehicle for a long period of time, washing the vehicle after work for the day is complete is recommended.
- When stepping onto the bumper to clean the windshield, do not hold the wiper arms. Doing so could cause a wiper malfunction.
- Do not use a vehicle-cleaning brush to clean the plastic lenses of the turn-signal lamps. A brush could scratch the lenses. Wash the lenses with water, then wipe them with a soft cloth.
- When the vehicle is washed, braking performance can be reduced by water entering the brake drums or splashed over the brake discs. In this event, drive slowly with light pressure on the brake pedal to dry out the brakes. Pay attention to nearby vehicles while doing so.
- When washing the vehicle, turn the air selector switch of the air conditioner to recirculate inside air so that water does not enter from the outside air inlet. Water entering from the outside air inlet causes damage to electrical components.
- When washing the vehicle, be careful not to allow water to get into the muffler. If water gets into the muffler, sensors could be damaged.
- Do not let water inside the engine compartment when washing the vehicle. Doing so will make the engine difficult to start, cause engine malfunctions or damage to electrical components.

NOTE:

Aluminum wheels may become whitish as oxide film forms on their surface over time. The color on the wheel near the exhaust pipe end may become yellowish. Regardless of the color, you can remove the oxide film by using a commercially available polish when washing the wheel.

When using a high-pressure cleaner to wash the underside of the vehicle, be sure to observe the following instructions.

- Set the steam temperature to 40°C {104°F} or less, and the pressure to 4.9 MPa {710 psi, 50 kgf/cm²} or less.
- Keep the cleaner nozzle 40 cm {15-inch} or more from the surface being cleaned.
- Do not concentrate the cleaner nozzle on the same location.

In addition, be careful not to point the jet of water at the areas listed below.

NOTE:

Avoid exposing these components and wiring to high-pressure water or cleaner steam as the system could be damaged and not operate properly.

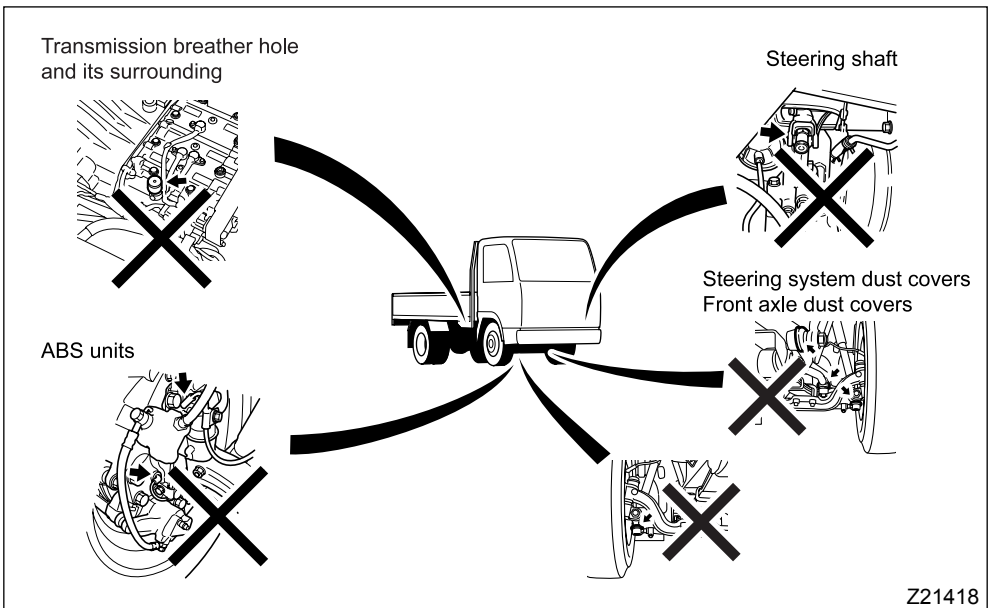

Z21418

- The air intake port or the area where it connects to the engine.
 - The starter, alternator, connectors, and other electrical parts
 - High-current fuse box
 - The engine compartment
 - Lamps
 - Around the wheels
- Steering shaft universal joint, steering system dust covers, front axle dust covers, and ABS units.

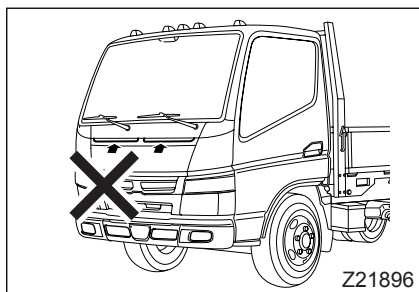

- The outside air inlets

1.2 Waxing

Wax the vehicle once or twice a month or whenever the wax on the vehicle ceases to repel water.

Apply wax out of direct sunlight and only when the vehicle's paintwork is cooler than human body temperature.

2 Rust and corrosion

- Rust and corrosion developing on the underside and/or undercarriage of the vehicle could cause an unexpected failure and even lead to an accident. Check these areas occasionally (such as after washing) for rust/corrosion and resulting holes. If rust is found, remove it using a wire brush and coat the affected area with a touchup paint or rust-preventive material. If you find a hole, have your vehicle repaired by an authorized dealer as soon as possible.
- To help keep your vehicle running reliably for a long time, you should conduct a detailed check for rust/corrosion at least once a year, and if necessary, apply touchup paint or rust-preventive material.

3 Interior cleaning

1. Remove dust with a vacuum cleaner.
2. Wet a soft cloth with a water solution containing neutral detergent, and wipe off any dirt.
3. Soak a soft cloth in clean water, wring it out and remove any remaining detergent.
4. Allow the vehicle to dry in a well ventilated area.



WARNING

When cleaning the interior and in particular the instrument panel, do not use polishing wax or a polishing cleaner. Doing so could cause the instrument panel to reflect off the windshield and result in an accident caused by interference to the driver's visibility.



CAUTION

Do not wash the floor of the cabin with water. Doing so could result in water splashing on relays, switches and other electrical components and cause a malfunction. It also causes rust.

NOTE:

- *Do not use organic solvent such as thinner or gasoline, or any acidic or alkaline solvents. Doing so causes discoloration or stains.*
- *Clean dirt off as soon as possible so that it does not leave marks or stains.*
- *If water has collected in the cab, either remove the drain plug from the floor and allow the water to drain out or wipe up all the water using a cloth.*

3.1 Cleaning seat belts

- Keep your vehicle's seat belts clean and dry at all times. Clean them with mild soap and luke-warm water. Never use gasoline, thinner, or other flammable liquids since these will weaken the webbing.
- Do not bleach or re-dye the webbing since this would seriously weaken it.

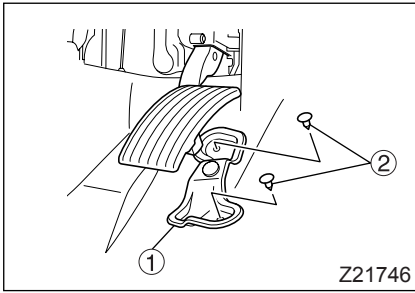

3.2 Removing floor mat for cleaning

1. Remove the accelerator pedal stopper ① by removing its screws ②.
2. Install the accelerator pedal stopper being careful not to let the cut edge of the floor mat become caught under the stopper.

! CAUTION

After cleaning the floor mat, dry the felt backing before putting the mat back on the floor. When fitting the floor mat back in the vehicle, make sure it does not interfere with the accelerator pedal and other moving parts. If the floor mat is interfering with the accelerator pedal, the pedal cannot return to the fully free position even when it is released, which could lead to an accident.

NOTE:

If you are unable to remove the accelerator pedal stopper screws, take the vehicle to an authorized dealer.

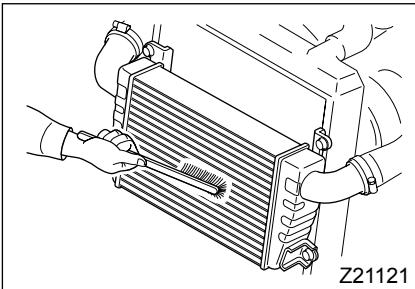

INTERCOOLER – CLEANING

If the front of the intercooler is heavily clogged with dust or mud, the engine performance may be affected. Clean it by using a soft brush or a similar tool.

! CAUTION

The intercooler could be damaged if a bristle brush or an object with a sharp point is used for its cleaning.

13. ROADSIDE EMERGENCY INFORMATION

POSSIBLE CAUSES AND SOLUTIONS	13-2
STOPPING YOUR VEHICLE IN AN EMERGENCY	13-7
IF THE ENGINE OVERHEATS	13-8
WHEN A FUSE HAS BLOWN	13-10
WHEN A LAMP HAS BURNED OUT	13-18
WHEN BRAKING IS SLUGGISH	13-28
IF THE ENGINE STALLS WHILE THE VEHICLE IS IN MOTION	13-28
IF A TIRE GOES FLAT WHILE THE VEHICLE IS IN MOTION	13-28
WHEN THE BATTERY HAS DISCHARGED	13-29
IF FUEL TANK BECOMES EMPTY (BLEEDING THE FUEL SYSTEM)	13-31
IF THE DEF TANK BECOMES EMPTY	13-31
TOWING	13-32
WHEN THE VEHICLE BECOMES STUCK IN SOFT GROUND	13-33

POSSIBLE CAUSES AND SOLUTIONS

Should your vehicle suffer a mechanical failure or malfunction, the solution to correct the problem can be found using the following chart.

If you are unable to correct the problem yourself or the problem persists after you have attempted to repair it, contact an authorized dealer for technical assistance.

The engine does not start.

The starter does not turn over or turns over too slowly.

Possible cause	Remedy	Ref. page
The starter switch fuse or high-current fuse is blown.	Replace the blown fuse or high-current fuse with a new one of the specified amperage.	13-10
Battery has discharged.	Charge or replace the battery.	13-29
Battery cable is disconnected, loose or corroded.	Remove corrosion and connect the cable correctly.	12-92
Connection to ground terminal is open.	Connect securely.	–
Engine oil viscosity is too high.	Replace the oil with an oil of proper viscosity.	12-22
The starter is malfunctioning.	Have an authorized dealer perform necessary inspection.	–
Communication with the engine immobilizer starter key is failed.	Check whether anything metallic or another key is touching the starter key.	3-3
The engine immobilizer system is faulty.	Have an authorized dealer perform the necessary inspection.	–

The engine does not start.

The starter turns over normally.

Possible cause	Remedy	Ref. page
Fuel has run out.	Refuel and bleed the system.	13-31
Air is present in the fuel system.	Bleed the system.	13-31
The fuel filter is clogged.	Replace the filter element.	12-45
Fuel is frozen.	Heat the fuel pipe with hot water [60°C (140°F) or less].	–
The air cleaner is clogged.	Clean or replace the air cleaner element.	12-52
The engine preheating time is insufficient.	Follow the preheating instructions.	5-7

Possible cause	Remedy	Ref. page
The preheating circuit fuse is blown.	Replace with a high-current fuse of the specified amperage.	13-16
The fuel injection system is malfunctioning.	Have an authorized dealer perform necessary inspection.	–
The BlueTec [®] exhaust gas aftertreatment is short of DEF.	Add the specified DEF.	1-8
A fluid other than the specified DEF is inside the tank.	Place the starter switch in the “LOCK” position, and immediately contact an authorized dealer who will discharge the fluid and inspect the vehicle.	–

The engine starts but stalls immediately.

Possible cause	Remedy	Ref. page
Idling speed setting is too low.	Have an authorized dealer perform necessary inspection.	–
The fuel filter is clogged.	Replace the filter element.	12-45
The air cleaner is clogged.	Clean or replace the air cleaner element.	12-52
The DPF is blocked.	Have an authorized dealer perform necessary inspection.	–

The engine fails to turn off.

Possible cause	Remedy	Ref. page
The fuel injection system is malfunctioning.	Have an authorized dealer perform necessary inspection.	–
The starter switch is malfunctioning.	Have an authorized dealer perform necessary inspection.	–

Black or white exhaust gas

Possible cause	Remedy	Ref. page
The DPF system is malfunctioning.	Have an authorized dealer perform necessary inspection.	–

The engine overheats.

Possible cause	Remedy	Ref. page
The front of the intercooler and radiator is plugged with dust and dirt.	Clean the intercooler and radiator with a soft brush.	12-66 12-101
The coolant level is too low.	Add coolant.	12-57

Possible cause	Remedy	Ref. page
The engine pressure cap is not closed completely.	Firmly install the cap.	–
The fan belt is loose.	Have an authorized dealer perform necessary inspection.	–
The coolant is contaminated.	Flush the cooling system and replace the coolant.	12-57

Engine oil pressure is low.

Possible cause	Remedy	Ref. page
Insufficient quantity of engine oil.	Add engine oil.	12-22
Engine oil viscosity is not adequate.	Replace the engine oil with one of a proper viscosity.	12-22

Fuel consumption is excessive.

Possible cause	Remedy	Ref. page
There is a fuel leak.	Check the fuel system and retighten connections as necessary.	–
The air cleaner is clogged.	Clean or replace the air cleaner element.	12-52
Tire pressure is too low.	Adjust to the adequate inflation pressure.	12-72
The clutch disc is worn.	Have an authorized dealer perform necessary inspection.	–

Engine oil consumption is excessive.

Possible cause	Remedy	Ref. page
The wrong oil is being used.	Replace the engine oil with a proper one.	12-22
There is too much oil.	Adjust the quantity to the proper level.	12-22
There is an oil leak.	Check the oil circuit and retighten connections as necessary.	–
Engine oil replacement intervals are too long.	Change the engine oil at prescribed intervals.	12-22
The oil filter is clogged.	Replace the filter element.	12-41

Engine power is insufficient.

Possible cause	Remedy	Ref. page
The parking brake is activated.	Release the parking brake completely.	5-15
The air cleaner is clogged.	Clean or replace the air cleaner element.	12-52
The fuel filter is clogged.	Replace the filter element.	12-45
Air is present in the fuel system.	Bleed the fuel system.	13-31
The clutch is slipping.	Have an authorized dealer perform necessary inspection.	–
The DPF is blocked.	Have an authorized dealer perform necessary inspection.	–
Crystallized DEF blocks the muffler.	Have an authorized dealer perform necessary inspections.	–

Braking is sluggish.

Possible cause	Remedy	Ref. page
Vacuum is insufficient.	Increase the engine speed to boost vacuum.	–
Brake fluid is insufficient.	Add brake fluid.	12-37
There is a vacuum leak.	Check the vacuum circuit and retighten connections as necessary.	–
The brake pads and the brake linings are worn.	Have an authorized dealer perform necessary inspection.	–
There is air in the brake fluid.	Have an authorized dealer perform necessary inspection.	–

The vehicle pulls to one side during braking.

Possible cause	Remedy	Ref. page
Tires are not uniformly inflated.	Inflate tires properly.	12-72
Tires are wearing unevenly.	Change the tires.	12-75
Cargo is heavier on one side than the other.	Load cargo evenly.	7-20

Steering is difficult.

Possible cause	Remedy	Ref. page
Cargo is over-loaded on the front side.	Load cargo evenly.	7-20
Power steering fluid is insufficient.	Add power steering fluid.	12-40
Front tire pressure is insufficient.	Inflate tires to recommended pressures.	12-72

The steering wheel vibrates.

Possible cause	Remedy	Ref. page
Wheel nuts are loose.	Tighten the wheel nuts to specification.	12-79
Tires are not uniformly inflated.	Inflate tires properly.	12-72
Tires are wearing unevenly.	Replace tires.	12-75
Tires are damaged.	Replace tires.	12-75
Wheels are not balanced properly.	Have an authorized dealer perform necessary inspection.	–
Brakes are not balanced properly.	Have an authorized dealer perform necessary inspection.	–

The steering wheel does not return to the straight ahead position smoothly.

Possible cause	Remedy	Ref. page
Parts are insufficiently greased.	Grease parts.	12-18

The lamp does not illuminate.

Possible cause	Remedy	Ref. page
The bulb is out.	Replace the bulb.	13-18
There is an open circuit or faulty grounding.	Have an authorized dealer perform necessary inspection.	–

The battery frequently discharges.

Possible cause	Remedy	Ref. page
The battery terminals have come off, are loose, or corroded.	Remove corrosion and tighten down terminals.	12-92
The fan belt is loose.	Have an authorized dealer perform necessary inspection.	–
The pulley of each auxiliary equipment is damaged.	Have an authorized dealer perform necessary inspection.	–
The battery is short of electrolyte.	Add battery electrolyte.	12-91
The life of the battery has expired.	Replace the battery.	12-93

Possible cause	Remedy	Ref. page
Idling speed setting is too low.	Have an authorized dealer perform necessary inspection.	–
Vehicle is used only at nighttime.	Charge the battery.	–
Switches are left on.	Be sure to turn off the switches.	–
Faulty alternator	Have an authorized dealer perform necessary inspection.	–

STOPPING YOUR VEHICLE IN AN EMERGENCY

Should a mechanical failure occur, do not panic. Simply slow your vehicle while paying attention to the vehicles behind you, and pull off the road at a place where you do not hinder the flow of traffic.

WARNING

- **Stopping your vehicle in a tunnel could be dangerous. Wherever possible, drive out of the tunnel before stopping the vehicle.**
- **Be sure to block the wheels with chocks after stopping the vehicle as mechanical failure may render the parking brake inoperative.**

NOTE:

If the engine stops, it is not possible to move the vehicle using only the starter.

1 Marking your vehicle

After you have pulled off the road, alert other drivers as follows so that they do not run into your vehicle.

- Flash the hazard warning lamps.
- If your vehicle carries reflective triangles, place them by the side of the road behind the vehicle.
- Attach a red flag or white cloth in a visible location.
- Ignite a flare if required.

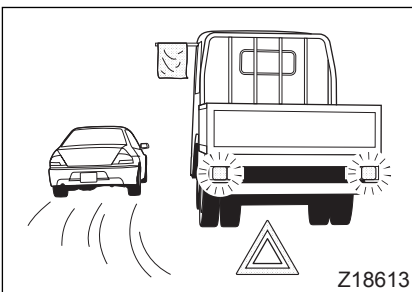

2 Repair

Inspect the mechanical failure and if you judge it readily repairable, repair it while paying attention to the traffic. If you are unable to repair it, call an authorized dealer for help.

WARNING

Never attempt to perform repairs on an expressway or in a tunnel. Doing so is very dangerous.

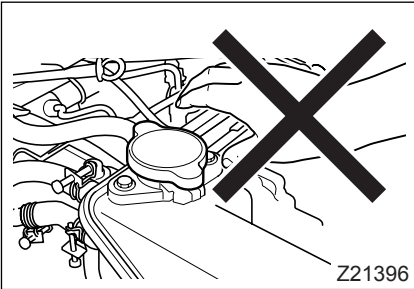

IF THE ENGINE OVERHEATS



WARNING

Never remove the pressure cap while the coolant is still hot. Carelessly removing it is dangerous since boiling coolant and hot steam will push out and could scald you. Only after the coolant has cooled down sufficiently, remove the pressure cap by gripping it in a folded piece of thick cloth and opening it slowly.



CAUTION

- Be sure to stop the engine only after letting it run at a speed slightly above the idling RPM until the coolant cools down. Turning off the engine immediately after stopping will cause the coolant temperature to rise quickly and may cause the engine to seize up.
- Suddenly pouring cold water into the radiator could make the engine crack. Supply cold water a little at a time.

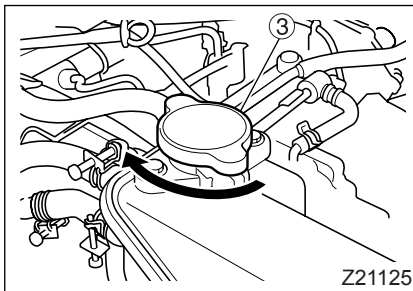
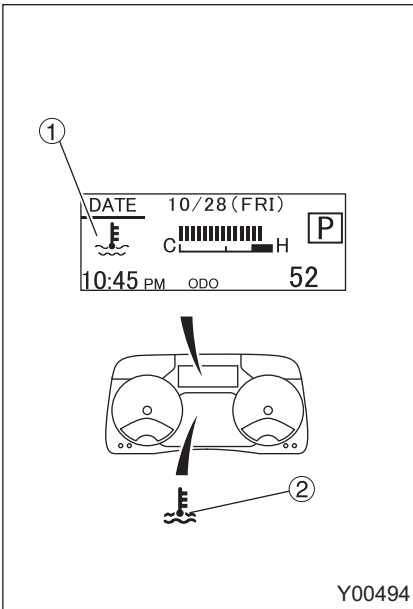

NOTE:

- When the multi-information display shows  ① in amber, the coolant temperature is abnormally high. The vehicle can still be driven.
- When the multi-information display shows  ① in red and the  warning lamp ② is illuminated, the coolant temperature is more higher. The engine power is limited, but the vehicle can still be driven.



If the  warning lamp comes on, the multi-information display shows  (red), and a buzzer sounds, the engine has overheated.

Stop the vehicle in a safe place, and keep it running at a speed slightly higher than the specified idling speed to cool down the engine. And then stop the engine, perform the following inspections:

1. Tilt the cab. ⇨  P. 12-6
If the vehicle is a Crew-cab model vehicle, uncover the engine access opening and the opening for inspecting the power steering oil and engine coolant. ⇨  P. 12-5
2. Check that coolant is not leaking from the radiator hoses or from other parts.
3. Check that the fan belt is not broken and that its tension is normal. ⇨  P. 12-66

4. Check the coolant level. If the level is too low, add coolant.
Refer to Page 12-58 for the recommended coolant for refilling.
 - Turn the pressure cap  counterclockwise to remove it, and fill coolant up to the pressure cap opening. Once filled, install the pressure cap by turning it clockwise.

CAUTION

Be sure to screw the pressure cap tightly. Otherwise, boiling water and steam under high pressure will push out if the engine overheats.

- Remove the reservoir tank cap, then add coolant until it reaches the “FULL” line. Install the cap securely after adding coolant.
5. Check that there is no dirt stuck to the front of the radiator. Remove any dirt from the front of the radiator.
 6. If the vehicle is not a Crew-cab model vehicle, lower the cab.
If the vehicle is a Crew-cab model vehicle, cover the engine access opening and the power steering fluid and engine coolant level inspection opening.
 7. If coolant leaks or the engine repeatedly overheats, the cooling system is faulty. Have an authorized dealer perform necessary inspection.

WHEN A FUSE HAS BLOWN

Your vehicle uses a 12V electrical system.

WARNING

- Be sure to set the starter switch to “LOCK” and turn off all other electric switches whenever replacing fuses or high-current fuses. Replacing any fuses or high-current fuses while electric circuits are still live could damage related electric equipment.
- Be sure to use fuses of the specified amperages.
A fire could result if a fuse of incorrect amperage is used. If a fuse is blown, have the vehicle inspected and the blown fuse replaced by an authorized dealer.
- Do not add wiring or modify equipment yourself. Doing so may result in faulty operation of the equipment and could cause the vehicle to catch fire due to overheated wiring. Always contact an authorized dealer if you intend to install additional electric equipment and it becomes necessary to modify the existing equipment or add new wiring.

CAUTION

- The BlueTec[®] exhaust gas aftertreatment continues to operate for approx. 2 minutes after placing the starter switch to the “LOCK” position. If you need to remove a fuse, do so after waiting for at least 2 minutes.
- Use care not to splash water on or around the fuse box cover. Should water be splashed over the fuse box cover, check the inside of the fuse box for water.
Any drops of water left inside the compartment could cause an electrical fault or fire.

The vehicle has blade-type fuses and high-current fuses. The blade-type fuses are in the fuse box located inside the cab and in the high-current fuse box located outside the cab. The high-current fuse box also contains the high-current fuses.

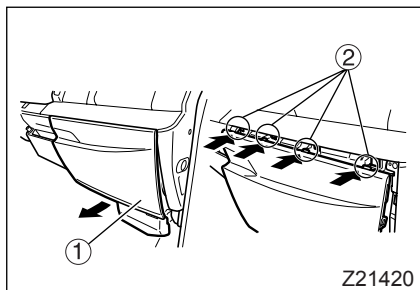

1 Fuse box

1.1 Removal and installation of lower panel in front of assistant driver's seat

1. Remove the lower panel ① in front of the assistant driver's seat.
2. Reinstall the lower panel by first aligning the tabs ② with the corresponding slots and then pushing the panel forward.

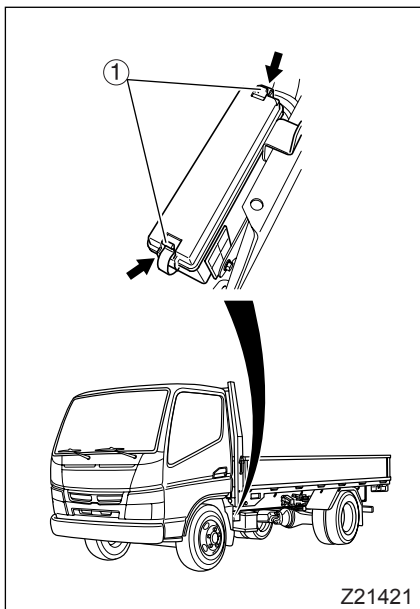

1.2 Removal and installation of high-current fuse box cover

1. Pry and release the two locks ① and remove the cover.
2. To install the cover, push in the cover until the two locks click.

2 Blade-type fuses

2.1 Inspection and replacement of blade-type fuses

1. Place the starter switch in the "LOCK" position and turn all other switches OFF.
2. Uncover the fuse box. ⇒  P. 13-11
3. To remove the fuse that is to be replaced, grip it using the fuse puller ② in the fuse box ①. The amperage and protected circuit of each fuse are shown on the inside of the lower cover.

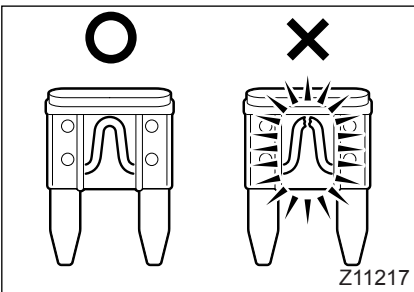
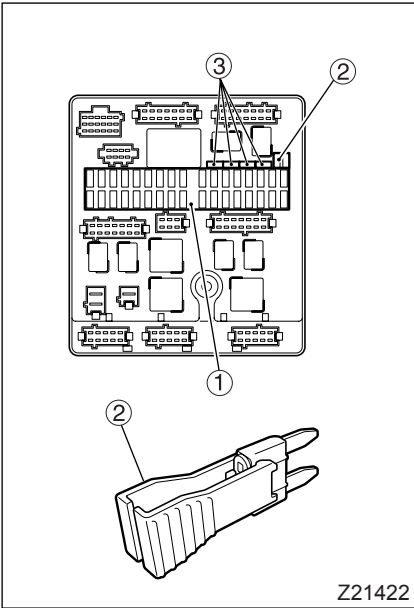

4. If a fuse is blown, be sure to select a spare fuse ③ of the specified amperage for replacement.

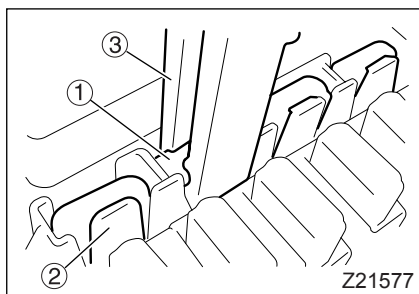

2.2 How to remove the spare fuse

Insert the puller ③ into the gap on the outer side of the fuse holder wall ② to remove the spare fuse ①.

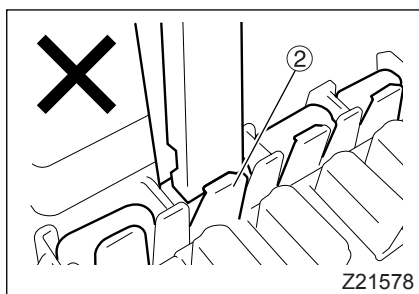

! CAUTION

Do not force the puller into the gap on the inner side of the fuse holder wall. Doing so will break the equipment and cause malfunctions or a fire.

<Fuse box>

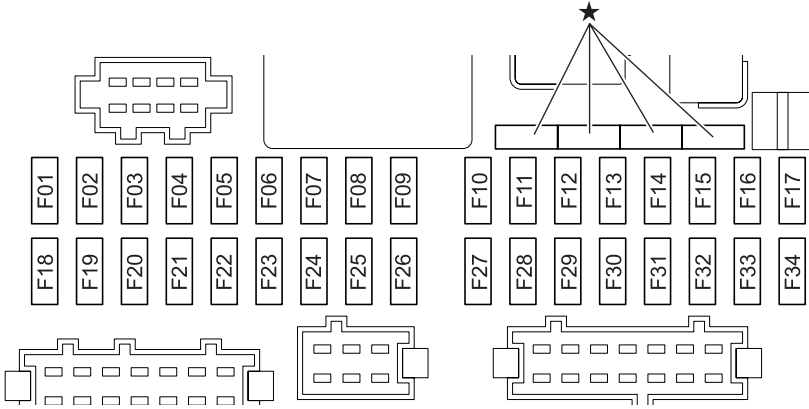

Z21425

<High-current fuse box>

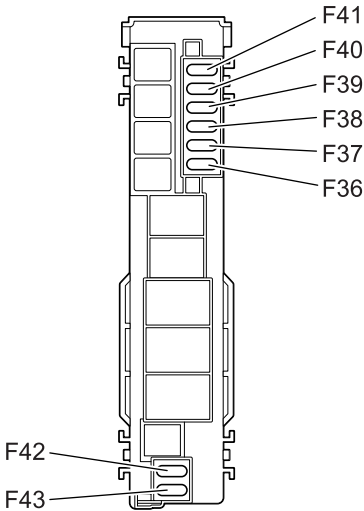

Z21747

Fuse No.	Amperage	Protected circuit
F01	10A	Starter
F02	10A	-
F03	10A	-
F04	10A	Accessory power supply (ignition circuit)
F05	30A	Power window (driver's)
F06	10A	-
F07	30A	Power window (assistant driver's)
F08	20A	Identification lamp
F09	10A	Meter cluster, diagnostic connector, combination switch
F10	30A	-
F11	30A	Air conditioner blower fan
F12	15A	Audio system, room lamp
F13	10A	Starter switch, engine immobilizer control unit

Fuse No.	Amperage	Protected circuit
F14	10A	Horn
F15	10A	Audio system, DUONIC® control unit
F16	20A	Cigarette lighter
F17	20A	Fuel heater
F18	10A	ABS control unit
F19	15A	Engine control unit
F20	10A	Front-wheel drive magnetic valve
F21	10A	–
F22	15A	Meter cluster, air conditioner control, rear air conditioner
F23	10A	–
F24	10A	DUONIC® control unit
F25	10A	Accessory power supply (starter switch ACC circuit)
F26	10A	Accessory power supply (battery circuit)
F27	20A	Van body dome lamp
F28	15A	Engine control unit
F29	20A	SCR system
F30	20A	SCR system
F31	20A	Engine control unit
F32	10A	Air conditioner compressor clutch
F33	–	–
F34	15A	Fuel pump
F35	–	–
F36	20A	DUONIC® control unit
F37	10A	Rear Blower fan motor
F38	15A	Rear condenser fan motor
F39	–	–
F40	20A	A/C condenser fan

Fuse No.	Amperage	Protected circuit
F41	30A	ABS control unit
F42	–	–
F43	–	–
*	10A	Spare fuse
	15A	
	20A	
	30A	

3 High-current fuse

The high-current fuses, which protect circuits in the same way as regular fuses, are fitted in a box next to the battery. If a high-current fuse is blown, most of the vehicle's electrical circuits become inoperative.

3.1 Inspection

- Place the starter switch in the "LOCK" position and turn all other switches OFF.
- Remove the high-current fuse box cover.

⇒  P. 13-11

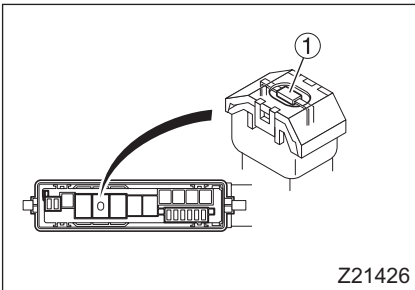

- Check for a blown high-current fuse by looking into the inside through inspection window ①. If it is blown, immediately call an authorized dealer and have them check your vehicle. The amperage of each fuse is shown on the inside of the high-current fuse box cover.

NOTE:

The high-current fuses may be hard to check depending on the position of a box.

If they are difficult to inspect, look into the inside through inspection window by tilting up the cab or using an appropriate mirror like a hand mirror.

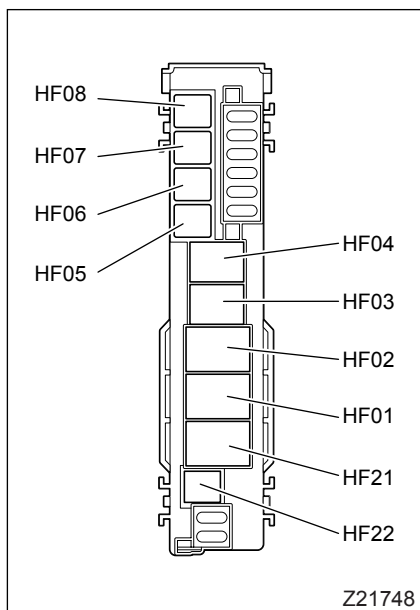

No.	Amperage (casing color)	Protected circuit
HF01	140A (russet)	SAM
HF02	–	–
HF03	80A (black)	SAM
HF04	–	–
HF05	60A (yellow)	Glow ECU
HF06	40A (green)	Starter relay
HF07	–	–
HF08	50A (red)	Hydraulic unit
HF21	–	–
HF22	40A (green)	SAM

! CAUTION

Close the cover completely to prevent water from entering the fuse box.

WHEN A LAMP HAS BURNED OUT

Whenever replacing a bulb, be sure to place the starter switch in the "LOCK" position and all other switches in the OFF position.



WARNING

- Use a bulb of the specified voltage and wattage shown in the following table. If a wrong bulb is used, an excessive current flowing through the wiring impairs the control functions of the electric equipment in the cab and of the rear body installations and eventually could cause a fire.
- Do not replace any lamp bulb immediately after it has gone out. The bulb is very hot then and could burn you. Be sure to wait long enough for the bulb to cool down before replacing it.
- Do not drop a lamp bulb. Flying fragments of glass could hurt you. Be especially careful when handling a halogen lamp bulb as its high inner pressure increases chance of injury.



CAUTION

- The turn signal lamps have plastic lenses. Do not clean these lenses with alcohol or thinner. Also, be careful not to splash brake fluid on them when adding it to the braking system. Contact with such a substance could discolor or crack the lenses. If such a substance gets on a plastic lens, immediately wipe it off or rinse it off with water.
- Burnt bulbs should be replaced as soon as possible.

NOTE:

In rainy weather and when the vehicle is washed, condensation can form on the inside surfaces of the headlamp lenses. Just as the windows mist up in rainy weather, the condensation forms owing to a temperature difference between the inside and outside. This phenomenon does not affect the headlamps' functionality. It disappears naturally.

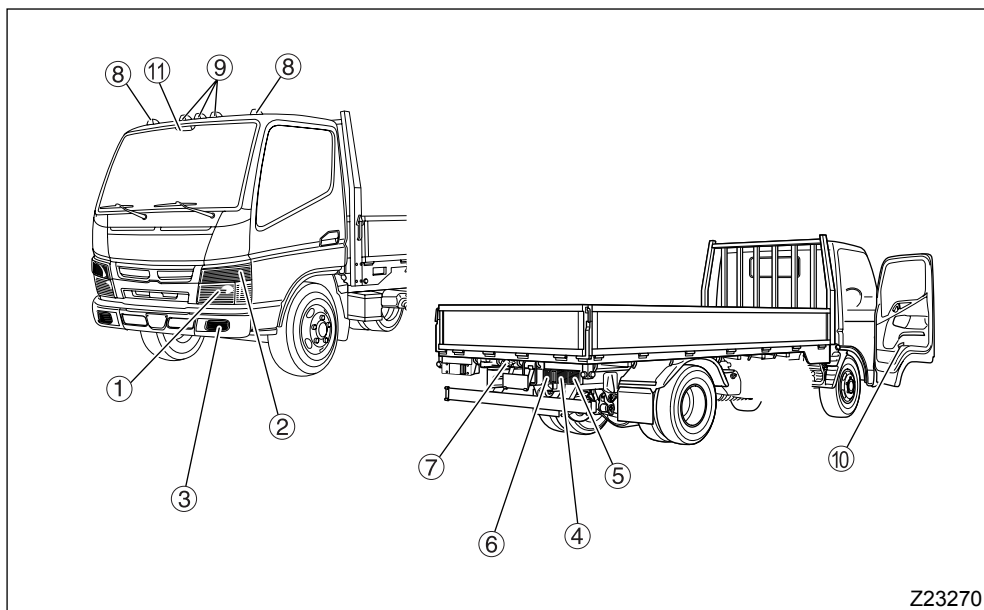

Z23270

Ref. No.	Lamp	Bulb wattage (bulb type)	Q'ty
①	Headlamp	12V-60/55W (HB2)	2
	Parking lamp	12V-5W (W5W)	2
②	Front and side turn signal lamp	12V-21W (W21W)	2
③	Front fog lamp*	12V-55W (H3)	2
④	Stop/tail lamp (double filament)	12V-21/5W (P21/5W)	2
⑤	Rear turn signal lamp	12V-21W (P21W)	2
⑥	Backup lamp	12V-21W (P21W)	2
⑦	License plate lamp	12V-10W (R10W)	1
⑧	Clearance and side marker lamp	12V-7.5W (A12V7.5W)	2
⑨	Identification lamp	12V-7.5W (A12V7.5W)	3
⑩	Step lamp	12V-5W (W5W)	2
⑪	Interior lamp <Type 1>	12V-10W	1
	Interior lamp <Type 2>	12V-8W	2

*: If equipped

1 Headlamp bulb replacement

For safety and simplicity, bulb replacement is performed with the headlamp removed. The radiator grill and the front and side turn signal lamp must be removed before the headlamp can be removed.

1.1 Headlamp removal and installation

• Removing the radiator grille

1. Remove the radiator grille screw ①.

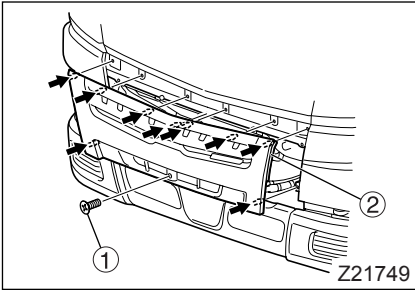

2. Remove the radiator grille by pulling outward on the clipped points in the order of the letters in the illustration.

NOTE:

Pull the grille straight forward and horizontally.

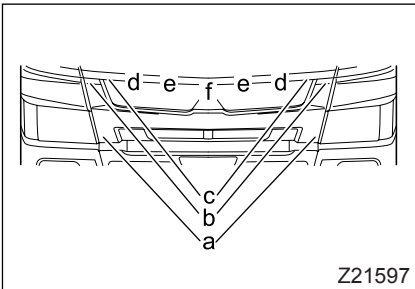

• Installing the radiator grille

1. Follow the removal procedure in reverse.
When installing the front grille, make sure the rubber packing ② at each side of the grille does not protrude from the clearance between the grille and lamp.
2. Install the screw.

NOTE:

After installing the front grille, check whether the rubber packing ② at each side of the grille is not protruding between the grille and lamp. If the packing is protruding, push it in so it can't be seen on the surface. Be careful not to damage the front grille or the lamps.

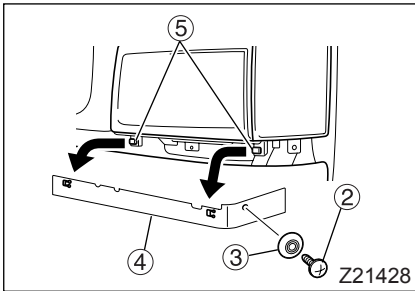

- **Headlamp removal**

1. Remove the screw ② and rivet ③, then move the lamp rubber ④ under the headlamp toward the centerline of the vehicle and release it from the tabs ⑤.

! CAUTION

When removing the lamp rubber, do not pull it with excessive force or the tabs could break.

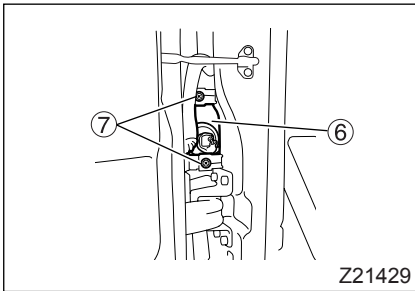

2. Open the door, then loosen the screws ⑦ behind the front and side turn signal lamp ⑥ until they spin freely.

NOTE:

Do not pull the screws hard. They are designed not to come out.

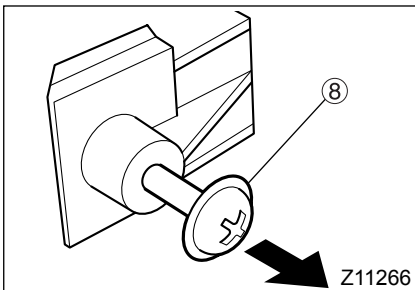

3. Pull out screw ⑧ toward you.

! CAUTION

Unless the screw is pulled out, the front and side turn signal lamp will catch on it and you will not be able to remove them.

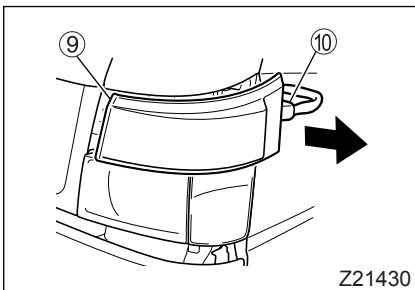

4. Close the door.
5. Remove the front and side turn signal lamp ⑨ toward the outside of the vehicle, then remove the socket ⑩.

! CAUTION

- When removing the front and side turn signal lamp, do not pull it forward (toward the front of the vehicle) or its tabs could break.
- Do not open the door with the front and side turn signal lamp moved outward (but not completely removed) or the door could hit and damage it.

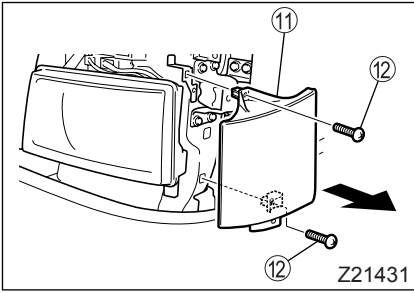

6. Remove the screws ⑫ of the garnish ⑪, then remove the garnish toward the outside of the vehicle.

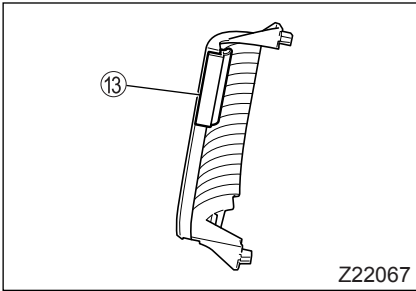

NOTE:
Do not remove the end rubber piece ⑬ from the garnish.

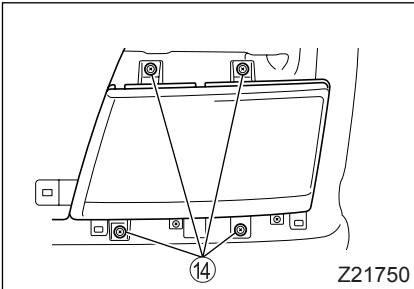

7. Remove the headlamp's bolts ⑭.

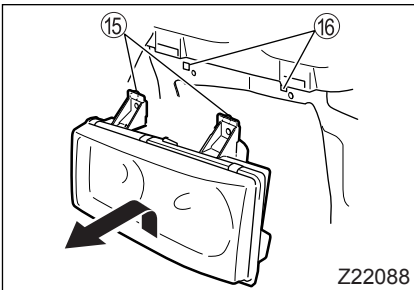

8. Raise the headlamp slightly to remove the tabs ⑮ from the holes ⑯, then pull it out toward you.

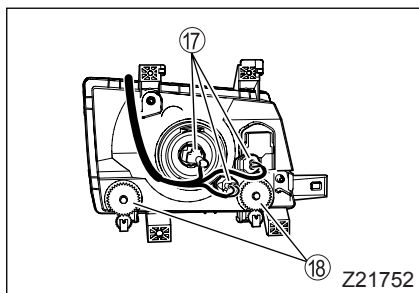

9. Remove the connectors ⑰ from the headlamp.

! CAUTION

- Do not turn the beam adjusting gear ⑱. Turning the beam adjusting gear would change the beam setting, thus creating a nuisance for drivers of other vehicles. If you accidentally turn the beam adjusting gear, have an authorized dealer perform necessary inspection.
- When setting down the removed headlamp, place it on a soft cloth to avoid scratching the lens.

• Headlamp installation

1. Install the connectors ① on the headlamp.

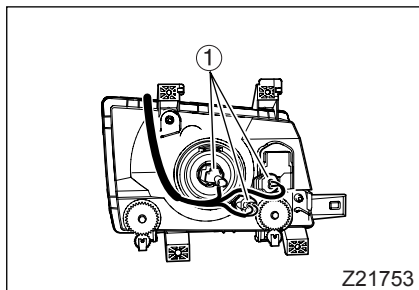

2. Insert the tabs ③ on the headlamp ② into the holes ④, and insert the headlamp in place.

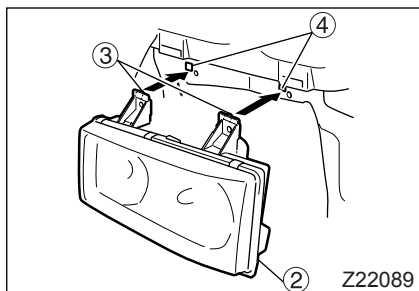

3. Install the headlamp's bolts ⑤.

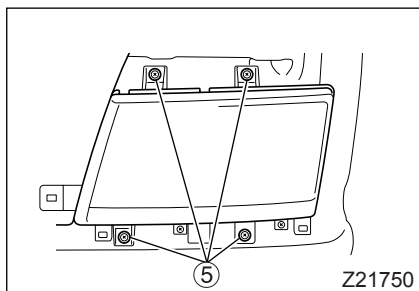

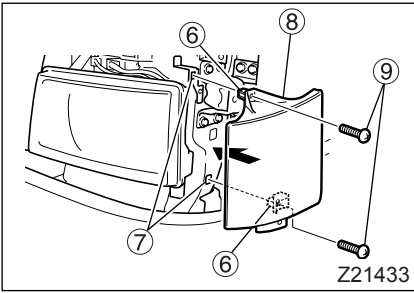

4. Insert the grommet ⑥ on the garnish ⑧ into the grommet hole ⑦, insert the garnish in place, and tighten the screws ⑨.

! CAUTION

Do not tighten the screw too tightly or the mounting could get damaged.

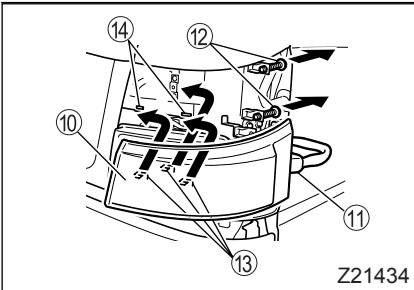

5. Install the socket ⑪ on the front and side turn signal lamp ⑩.
6. Pull out screws ⑫.
7. Align the tabs ⑬ with the holes ⑭, then press the lamp in toward the centerline of the vehicle.

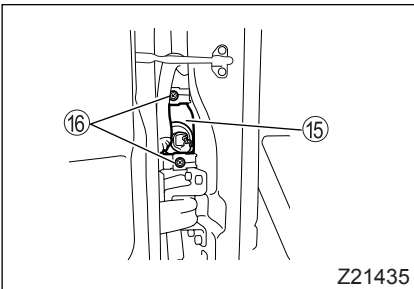

8. Open the door, then tighten the screws ⑯ behind the front and side turn signal lamp ⑮.

! CAUTION

- Press the front and side turn signal lamp fully in toward the centerline of the vehicle. If the lamp was not pressed fully into place and you opened the door, the door could hit the lamp and damage it.
- Do not tighten the screws too tightly or the mounting could get damaged.

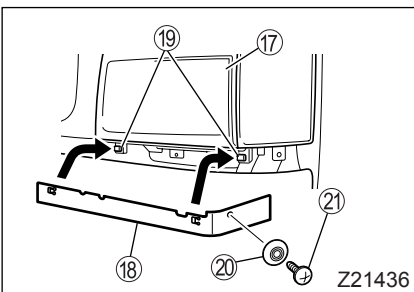

9. Insert the lamp rubber ⑱ under the headlamp ⑰ onto the tabs ⑲ by moving it toward the outside of the vehicle.
10. Install the rivet ⑳, then press in the screw ㉑.

1.2 Headlamp bulb replacement

⚠ CAUTION

- Do not directly touch the glass part of a halogen bulb with your fingers. Any oil and other substances contaminating the glass surface could shorten the bulb's service life.
- Do not clean lamps with alcohol and thinner, because their lenses are made of plastic.
- Do not attach any sticker or tape on the headlamp lens. Doing so may result in deformation of the lens by heat since the lens is made of plastic.

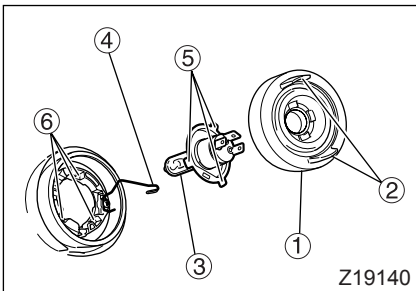

- **Removal**
 1. Remove the cover ① by pulling on the lugs ② of the cover.
 2. Detach the spring ④ retaining the bulb ③.
 3. Pull out the bulb.

• Installation

1. Install the bulb in the lamp unit while aligning the tabs ⑤ with the grooves ⑥, then secure the bulb with the spring.
2. Clean the inside of the cover, if necessary.
3. Install the cover by pushing it until the bulb end ⑦ is slightly exposed. Push the shaded area when installing the cover.

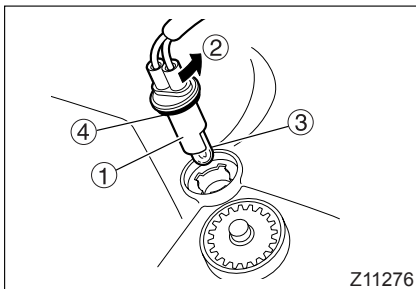
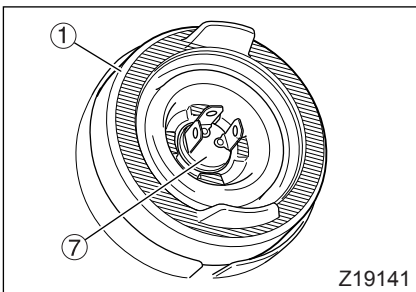

1.3 Parking lamp bulb replacement

1. Turn the socket ① in the direction of the arrow ② to remove it.
2. Remove the bulb ③.
3. Perform installation by following the removal steps in reverse.
4. If the packing ④ is dirty, clean it.

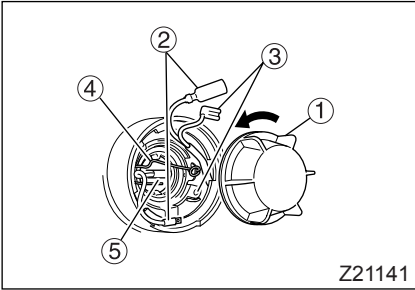

Z21141

2 Replacing the fog lamp bulb

• Removal

1. Tilt up the cab if it has a tilting mechanism.
2. Turn the cover ① counterclockwise to remove it.
3. Disconnect the bulb connector ②.
4. Disconnect the connector ③ from the lamp unit.
5. Unhook the spring ④, then pull out the bulb ⑤.

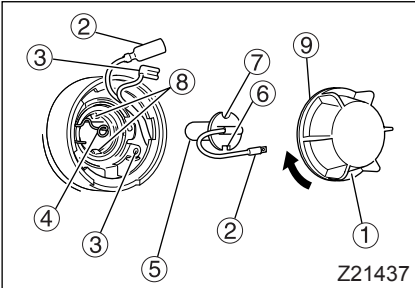

Z21437

• Installation

1. Hold the bulb with the square groove ⑥ at the top (with the circular groove ⑦ at the bottom), then align the bulb with the lugs ⑧ on the fog lamp unit, install it and fix it with the spring ④.
2. Reconnect the connector ② of the bulb.
3. Reconnect the connector ③ to the fog lamp unit.
4. Clean the packing ⑨ if necessary. Also straighten the packing if it is twisted.
5. Install the cover on the lamp unit and turn it clockwise.
6. Lower the cab if it was tilted up.

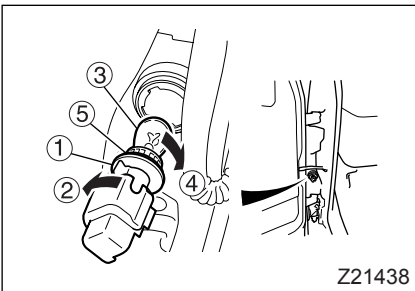

Z21438

3 Front and side turn signal lamp bulb replacement

1. Open the door.
2. Turn the socket ① in the direction of arrow ② to remove it.
3. Press the bulb ③ and turn it in the direction of arrow ④ to remove it.
4. Perform installation by following the removal steps in reverse.
5. If the packing ⑤ is dirty, clean it.

4 Interior lamp bulb replacement

4.1 Type 1 <front and rear seats>

1. Insert a flat-blade screwdriver ③ between the lens ① and the interior lamp ② and use it to release the tabs ④ on the bottom of the lens. Remove the lens.
2. Push the bulb retainer ⑥ rightward and remove the bulb ⑤.
3. To install the lens, insert the tabs ⑦ on the top of the lens and press the bottom of the lens into place.

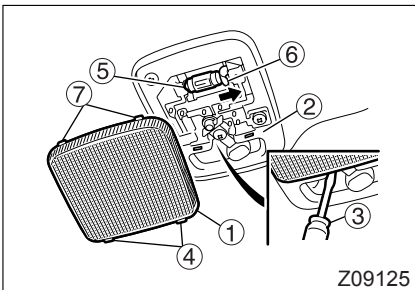

Z09125

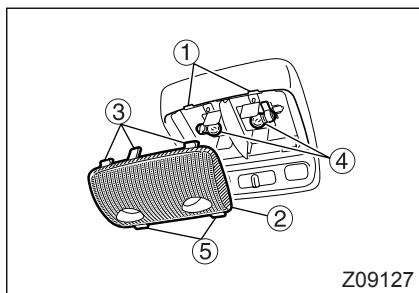

Z09127

4.2 Type 2 *

1. Insert a flat-blade screwdriver into the notches ① and use it to release the tabs ③ on the top end of the lens ②. Remove the lens.
2. Remove the bulb ④ by turning it counterclockwise while pushing inward.
3. Install the lens by inserting the tabs ⑤ at the bottom end of the lens into the slots and pushing the lens while aligning the tabs on the top end with the notches.

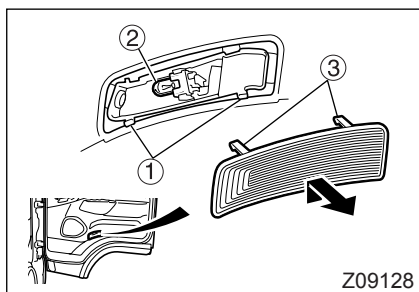

Z09128

5 Step lamp

1. Insert a flat-blade screwdriver into the tab ① locations at the bottom end of the lens and remove the lens by pulling it toward you while raising it.
2. Pull out the bulb ②.
3. Install the lens by inserting the tabs at the bottom end into the slots and then pushing the locations of the tabs ③ at the top end of the lens.

6 Replacing other lamp bulbs

1. Loosen the screw that secures the lens then remove the lens.
2. Turn the bulb counterclockwise while pressing it and remove it.
3. Insert a new bulb and turn it clockwise.
4. Install the lens, ensuring that the packing is correctly positioned. If the packing is incorrectly installed or twisted, water can enter the lamp and shorten its life. If the packing is dirty, clean it.
5. Uniformly tighten the screws that retain the lens.

WHEN BRAKING IS SLUGGISH

WARNING

- Never use the parking brake during driving except in an emergency. Pulling the parking brake lever with full force while driving could cause the vehicle to topple over.
- Never continue driving with the brake system malfunctioning or leaking fluid. Continuing to drive without taking necessary actions could lead to a serious accident.

Depress the brake pedal harder than usual, downshift to use engine braking and activate exhaust braking* to stop the vehicle. Apply the parking brake when necessary. After the vehicle has been brought to a stop, check each part. ⇨  P. 12-69

*: If equipped

IF THE ENGINE STALLS WHILE THE VEHICLE IS IN MOTION

The vehicle will be set into the following very dangerous conditions. Pull the vehicle over when safe to do so and try to start the engine.

- The braking force reduces extremely. You must exert additional force on the brake pedal to apply the brakes.
- The power steering system then becomes inoperative, making steering extremely difficult. Additional force must be used when turning the steering wheel.

IF A TIRE GOES FLAT WHILE THE VEHICLE IS IN MOTION

Avoid sudden braking. Hold the steering wheel firmly, and gradually slow down before pulling over at a safe place.

To replace the tire, select a flat surface where your vehicle will not hinder traffic. ⇨  P. 12-75

WHEN THE BATTERY HAS DIS-CHARGED

Perform the following procedure to start your engine by connecting your battery to the well charged battery of another vehicle with booster cables.

WARNING

- Check the battery's fluid level before connecting booster cables. If the fluid is below the "LOWER" level line, add battery fluid or distilled water. If the battery was charged with an excessively low fluid level, it would deteriorate rapidly and could overheat or explode.
- Be careful not to connect the booster cables in the wrong sequence. Sparks are often produced when you connect the booster cable to the vehicle's frame. Therefore, if the cable is connected to a section of the frame near the battery, the spark could set off the hydrogen given off by the battery to cause an explosion. Be sure to connect the cable end to a point as far away as possible from the battery. Also, keep cigarettes and open flames well away from the battery.
- Unless absolutely necessary, do not start the engine by towing or pushing the vehicle. Doing so is dangerous because the brakes work poorly and the steering wheel becomes very difficult to turn.

CAUTION

- Use booster cables able to handle large currents.
- Your vehicle's electrical system operates on a 12V power supply. Confirm that the vehicle giving the boost also has a battery or batteries connected for 12V power supply.
- When charging the battery, remove it from the vehicle.

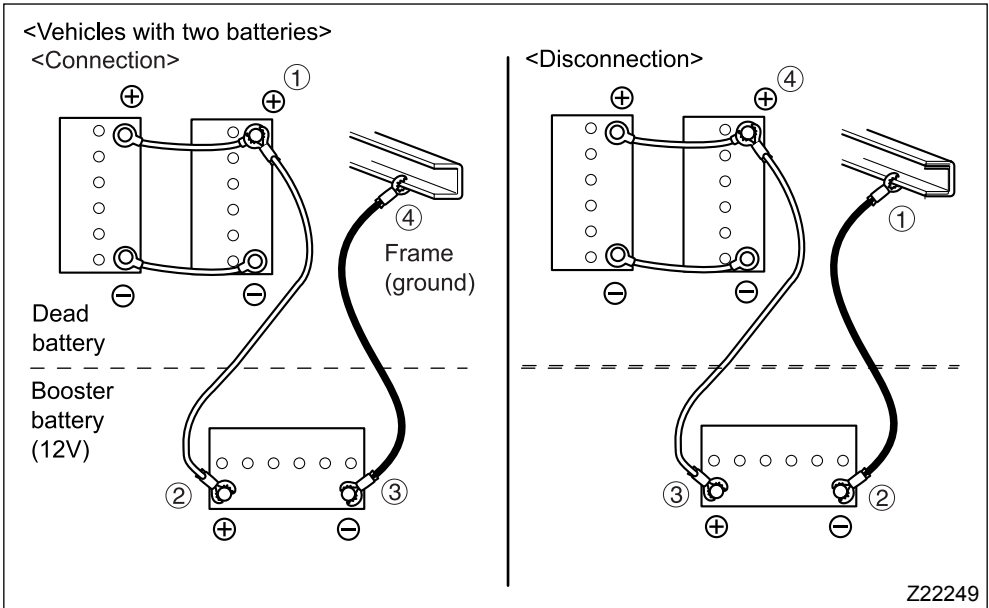

1. Stop the engine of the vehicle giving the boost.
2. Remove the battery cover of the vehicle with the dead battery. ⇒ P. 12-90
3. Connect one end of the red booster cable to the positive (+) terminal ① of the dead battery. Connect the other end of the red booster cable to the positive (+) terminal ② of the booster battery.
4. Connect one end of the black booster cable to the negative (-) terminal ③ of the booster battery and connect the other end of the black booster cable to a section of frame ④ (ground) on the vehicle with the dead battery at a point as far away as possible from the battery.
5. After the above connections have been completed, start the engine of the vehicle with the booster battery and let it run at an RPM slightly higher than idling speed. Then, attempt to start the engine of the vehicle with the dead battery. If the engine starts with difficulty because of cold weather or a dead battery, let it draw a charge for several minutes from the vehicle from which you are receiving the boost before attempting to turn over the engine.
6. After the engine of the vehicle with the dead battery has been started, disconnect the booster cables by reversing the order of connection.

TOWING

If you are forced to tow the vehicle, take the following precautions:

- On an FE model vehicle, disconnect either the propeller shaft or the rear axle shaft, whichever is easier.

If you disconnect the rear axle shaft, cover the opening to prevent oil and grease from escaping.

! CAUTION

- On an FE model vehicle, disconnect the propeller shaft or rear axle shaft. Alternatively, tow the vehicle with its rear wheels off the ground. Towing the vehicle without taking these precautions would damage the transmission.
- Before towing a 4WD vehicle, raise the front wheels and disconnect the propeller shaft at the rear.
- While disconnecting the propeller shaft, the engine brake and the exhaust brake cannot be applied.

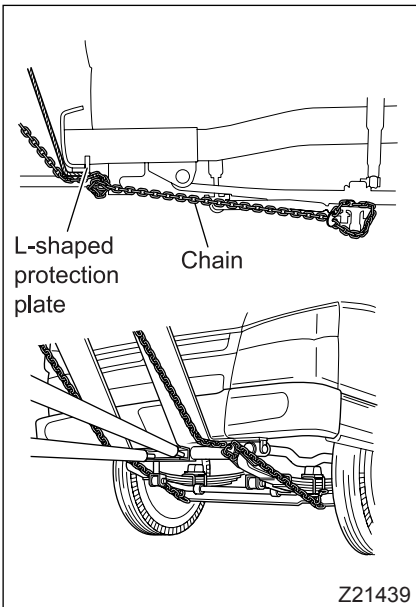

Z21439

- To prevent damage to the front bumper when raising the front wheels, attach an L-shaped protection plate.
- Attach the towing chain securely to the front axle.

! CAUTION

- Do not attach the chain to the bumper since the bumper would be damaged upon raising the front wheels or towing.
- Before raising the front wheels or towing, confirm that the chain will not damage the stabilizer or any other part of the vehicle. If the chain looks likely to cause damage, use thicker L-shaped protection plates to hold the chain further from the vehicle.
- Tow the vehicle only with a specially designed towing truck.
- If you disconnect the rear axle shaft to tow the vehicle, the axle housing gear oil may deplete. Check the axle housing gear oil and add more if necessary.

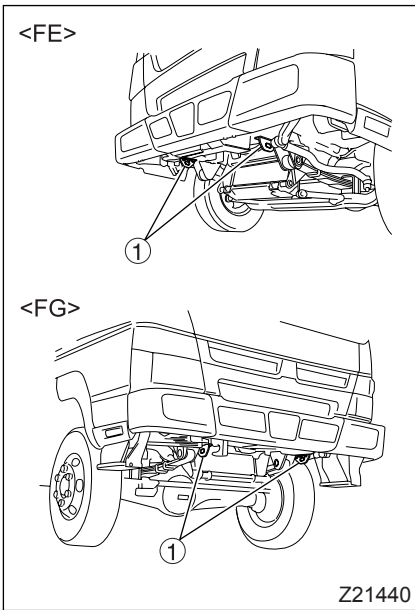

- Never use the tie-down hook(s) ① under the frame for towing purpose. The tie-down hook is to secure the vehicle when transporting it. If the hook is used for towing, damage to the front bumper or frame may result.

WHEN THE VEHICLE BECOMES STUCK IN SOFT GROUND

<FG>

If the vehicle becomes stuck in sand, mud, or snow, free it by driving forward and backward.

⇒  P. 7-14

If this method is not successful, free the vehicle by towing it as described below.

CAUTION

- Use the towing method described in this section only to free the vehicle from soft ground. To tow the vehicle in the event of a breakdown, use the procedure described in the previous section.
- The stranded vehicle must be unloaded of all cargo.

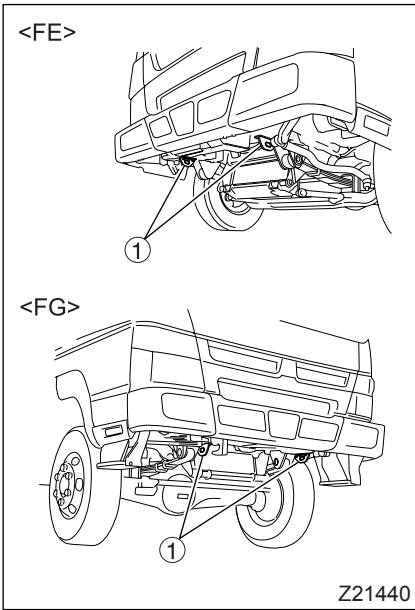

- Never use the tie-down hook(s) ① under the frame for towing purpose. The tie-down hook is to secure the vehicle when transporting it. If the hook is used for towing, damage to the front bumper or frame may result.

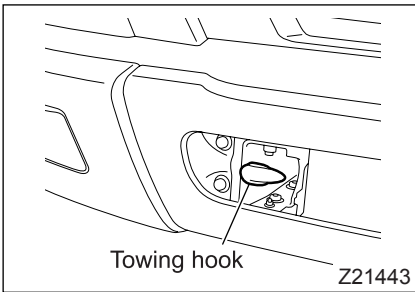

1. Tow the stranded vehicle using a vehicle whose gross weight is equal to that of the stranded vehicle (14,050 lbs., 6,375 kg). Attach the rope or wire rope to the towing hook of the towing vehicle.
2. Attach the other end of the rope or wire rope to the towing hook of the stranded vehicle. If necessary, use another towing hook that is located behind the left-hand side rail.

⚠ WARNING
To avoid the risk of a serious accident, make sure the rope or wire rope is strong enough to tow the stranded vehicle and make sure it does not slip off either vehicle's towing hook.

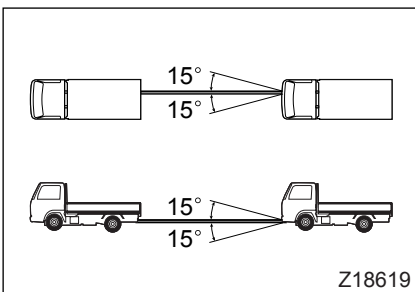

3. For the sake of safety, the angle formed by the tow rope when hooked up should be limited to the range indicated in the illustration. Do not tow a vehicle under conditions which could impose sudden undue stress on the hooks (for instance, towing a vehicle out of a ditch) as doing so could break the hooks.
4. Start each vehicle's engine and prepare to start driving.
5. If the rope or wire rope is slack, slowly move the towing vehicle until the slack is eliminated.

6. Slowly drive both vehicles forward. Do not race either vehicle's engine.
7. When the towed vehicle becomes free, promptly stop each vehicle by applying the brake pedal. To make the rope or wire rope easy to remove from the towing hooks, let it become slightly slack before stopping the towed vehicle.

14. VEHICLE SERVICE SPECIFICATIONS

RECOMMENDED LUBRICANTS/HYDRAULIC FLUIDS AND QUANTITIES 14-2
VEHICLE SERVICE SPECIFICATIONS 14-4

RECOMMENDED LUBRICANTS/HYDRAULIC FLUIDS AND QUANTITIES

1 Lubricant/hydraulic fluids and quantities

liters (qts)

Item			Quantity
Engine	FE	Replacing oil	Approx. 7.2 (7.6)
		Replace the oil and the filter at the same time	Approx. 7.7 (8.1)
	FG	Replacing oil	Approx. 5.5 (5.8)
		Replace the oil and the filter at the same time	Approx. 6 (6.3)
Clutch		Oil pan	Approx. 2.0 (2.1)
		Total (including clutch control fluid in oil pan, oil filter and clutch control fluid cooler)	Approx. 4.7 (5.0)
Transmission			Approx. 3.5 (3.7)
Transfer <FG>			Approx. 3.6 (3.8)
Axle housing	FE		Approx. 4.5 (4.8)
	FG	Front axle	Approx. 3.0 (3.2)
		Rear axle	Approx. 4.5 (4.8)
Power steering			Approx. 1.5 (1.6)
Brake fluid			As required

CAUTION

The indicated oil and fluid quantities should be used only as a guide at the time of replacement. To ensure correct oil and fluid levels, use the oil level gauge, inspection plug holes, and level lines as appropriate.

2 Recommended lubricants/hydraulic fluids

Be sure to use the specified lubricants and hydraulic fluids.

Parts	Category	Classification	Viscosity	
			Ambient temperature	SAE viscosity number
Engine	Engine oil	API CJ-4	–	5W-30 (Standard) 10W-30 (In emergency case)
		ACEA C2	–	5W-30
Transmission Transfer <FG>	Gear oil	API GL-3	General	80
			Warm region	90
		API GL-4	General	80
			Tropical region	90
Clutch	Automatic transmission fluid	FUSO ATF SP III or Exxon Mobil ATF 3309	–	–
Axle housing *1	Gear oil	API GL-5	Below 40°C (104°F)	90
			Above 40°C (104°F)	140
Limited-slip differential <vehicles with limited slip differential>	FUSO LSD GEAR OIL or an equivalent	API GL-5	–	90
Power steering	Automatic transmission fluid	DEXRON II or DEXRON III type	–	–
Brake	Brake fluid	SAE J1703, FMVSS No. 116 (Grade DOT3)	–	–
Chassis grease nipples (rear spring pin, king pin) Door hinges Anchor hooks <Vehicles other than Crew-cab models>	Chassis grease	NLGI No. 1 (Li soap) Consistency 310 to 340 (at 25°C or 77°F) Dropping point 130°C (266°F) or higher	–	–
Wheel hub bearing Propeller shaft (universal joint, slip joint, double cardan joint <FG>)	Wheel bearing grease (Multipurpose type grease)	NLGI No. 2 (Li soap) Consistency 265 to 295 (at 25°C or 77°F) Dropping point 185°C (365°F) or higher	–	–
Propeller shaft center bearing	Bearing grease	NLGI No. 3 (Li soap) Consistency 220 to 250 (at 20°C or 68°F) Dropping point 250°C (482°F) or higher Usable temperature range –40 to 150°C (–40 to 302°F)	–	–

*1: At ambient temperatures higher than 10°C (50°F), use an oil conforming to GL-5, SAE140 if the vehicle is used under such a heavy load conditions as continuous upgrade climbing.

VEHICLE SERVICE SPECIFICATIONS

Description			Standard value
Engine idling speed			800 rpm
Coolant quantity	Vehicles other than those specified below		Approx. 13.7 liters (14.5 qts)
	Crew cab (with rear air conditioner)		Approx. 14.8 liters (15.6 qts)
	Crew cab (with rear heater)		Approx. 14.9 liters (15.7 qts)
Brake pedal play (at center of pedal pad)			0.1 to 3 mm (0.0039 to 0.12 in.)
Fully depressed brake pedal to floor clearance			10 mm (0.39 in.) or more
Parking brake lever stroke (When pulled with a force of 294 N {66 lbs., 30 kgf}.)			7 to 9 notches
Steering wheel play (as measured on the periphery of steering wheel)	When engine is turned off		10 to 20 mm (0.39 to 0.79 in.)
	When engine is idling		5 to 50 mm (0.20 to 1.97 in.)
Tire tread groove depth			1.6 mm (0.06 in.) or more
Wheel nut tightening torque			440 to 540 N·m (325 to 398 ft.lbs., 45 to 55 kgf·m)
Tire inflation pressure	FEC5	LT215/85R16-10PR (Load Range E)	550 kPa (80 psi, 5.5 kgf/cm ²)
	FEC7 FEC9 FECX	215/75R17.5 124/123L (Load Range F)	690 kPa (100 psi, 7.0 kgf/cm ²)
	FG	LT235/85R16-10PR (Load Range E)	550 kPa (80 psi, 5.5 kgf/cm ²)

15. MAINTENANCE SCHEDULE

Regular maintenance is vital to maximizing your vehicle's performance, service life, and safety.

Following the maintenance schedule will give optimum results.

When doing inspections or replacing things, replace things that have both a use-by date and mileage limit at whichever comes first.

The preceding sections describe simple maintenance checks and procedures that can be carried out by the owner. If you have difficulty or your vehicle needs maintenance work that is not shown in this manual, please take the vehicle to an authorized dealer.

1 Maintenance schedule for severe use

In some maintenance items, the severe use maintenance schedule is recommended.

Perform each item of inspection or replacement according the "Severe use" interval if the type of severe use in Item column of the periodic inspection schedule table corresponds to one of the conditions in the following table (A) ~ (K).

Severe condition types	Conditions of severe use
A	Operating in slow vehicle speed (lower than 20 km/h (12 mph) in average and more than 30% of total operation) or operations involving frequent starts and stops.
B	Operations involving frequent engine starts and stops condition in 10 minutes and in 10 km (6 miles) distance.
C	Long time idling usage such as average vehicle speed of a day is 20 km/h (12 mph) or less.
D	Operating on over loading condition (more than 30% in total operation)
E	Operating on rough roads (more than 30% in total operation)
F	Operating in tropical region (above 46°C (114°F))
G	Operating in cold region (lower than -25°C (-13°F))
H	Operating in dusty areas
I	Operating on long distance (10,000 km/month (6,000 miles/month) or more)
J	Operating on frequent mountainous roads (more than 30% in total operation)
K	Operating on frequent uphill roads trip (more than 30% in total operation)

2 Maintenance schedule

For the lubricant and fluids replacement intervals, see the section entitled "Lubrication schedule".

Symbols used

I : Inspect, and correct or replace as necessary.

A : Adjust.

C : Clean.

R : Replace or change.

T : Tighten.

L : Lubricate.

•: No inspection is necessary.

Ⓔ: Exhaust emission items.

Ⓝ: Noise control items.

Item	Time of inspection and maintenance					Working procedures	
	Pre-operational checks	Inspection interval					
		Every 16,000 km (10,000 miles)	Every 32,000 km (20,000 miles)	Every 48,000 km (30,000 miles)	Every 64,000 km (40,000 miles)		Every 80,000 km (50,000 miles)
ENGINE							
Ⓔ Oil filter replacement	•	R:Every 16,000 km (10,000 miles) or 12 months				Replace oil filters. ⇒ P. 12-41	
Ⓔ PCV filter replacement	•	R:Every 48,000 km (30,000 miles) or 36 months				Replace PCV filter.	
Ⓔ Fuel filter replacement	•	R:Every 32,000 km (20,000 miles) or 12 months				Replace fuel filter. ⇒ P. 12-45	
Ⓔ Fuel line leakage and damage	Normal condition	•	I:Every 24 months			Check for leakage of fuel from the fuel line. Check the pipe, hose and tube for damage and loose installation.	
	Severe condition (type (D)~(F))*	•	I:Every 12 months				
ⒺⓃ V-belt tension and damage	I	I:Every 32,000 km (20,000 miles) or 12 months				Inspect belts for crack, wear and tension. ⇒ P. 12-66	
ⒺⓃ Alternator	•	I:Every 32,000 km (20,000 miles) or 12 months				Check bearing rotation condition of 1way clutch pulley for alternator.	
Ⓔ Cooling system	•	I:Every 32,000 km (20,000 miles) or 12 months				Check radiator and pressure cap for sealing performance and mounting condition. Inspect hoses for looseness, deterioration, damage causing leakage. Remove dust and foreign matter deposit from radiator and inter-cooler front.	
Coolant level	I	•	•	•	•	•	Check that the coolant level is between the "FULL" and "LOW" marks on the reservoir tank. ⇒ P. 12-61
Coolant replacement	•	R:Every 24 months				Replace coolant. ⇒ P. 12-57	
ⒺⓃ Air cleaner element replacement	•	•	R	•	•	•	Replace air cleaner element. ⇒ P. 12-52
ⒺⓃ Exhaust system	•	I:Every 32,000 km (20,000 miles) or 12 months				Inspect the exhaust system for damage, corrosion and loose connection causing leakage.	

* For about severe conditions, refer to the "For maintenance schedule in severe use". ⇒ P. 15-2

Item	Time of inspection and maintenance						Working procedures
	Pre-operational checks	Inspection interval					
		Every 16,000 km (10,000 miles)	Every 32,000 km (20,000 miles)	Every 48,000 km (30,000 miles)	Every 64,000 km (40,000 miles)	Every 80,000 km (50,000 miles)	
Ⓔ DPF	•	I:Every 32,000 km (20,000 miles) or 12 months					Check DPF for damage and for leaks of exhaust gases. Check mounting bolts and nuts for looseness. Check mounting brackets for damage.
Ⓔ DEF line leakage and damage	•	I:Every 32,000 km (20,000 miles) or 12 months					Check for leakage of DEF from the DEF line. Check the pipe, hose and tube for damage and loose installation.
ⒺⓃ Alternator tensioner replacement	•	R:Every 224,000 km (140,000 miles) or 72 months					Replace alternator tensioner.
Glow plug replacement	•	R:Every 224,000 km (140,000 miles) or 72 months					Replace glow plug.
POWER TRAIN							
Clutch control fluid filter replacement	•	•	•	•	R	•	Replace clutch control fluid filter.
Propeller shaft flange torque and universal joint looseness	•	•	I	•	•	•	Check flange yoke bolts for looseness and universal joint for play.
Propeller shaft center bearing	•	•	•	•	•	I	Check center bearing for wear, damage and play.
Propeller shaft bearing kit	•	R:Every 192,000 km (120,000 miles) or 120 months					Replace propeller shaft bearing kit.

Item		Time of inspection and maintenance						Working procedures
		Pre-operational checks	Inspection interval					
			Every 16,000 km (10,000 miles)	Every 32,000 km (20,000 miles)	Every 48,000 km (30,000 miles)	Every 64,000 km (40,000 miles)	Every 80,000 km (50,000 miles)	
FRONT AND REAR AXLE								
Wheel and tire		I	•	•	•	•	•	Check the disc wheels for cracks and other damage. Check the tires for inflation pressure, tread groove depth, foreign objects in grooves, cracks, and uneven wear. ⇒ P. 12-72, 12-84
		I	•	•	•	•	•	Check tire tread and side wall for cracks and damage. Measure tire tread groove depth to make sure it is deep enough. Check tire tread for uneven wear, stepped wear and other abnormal wear. ⇒ P. 12-72
		A	•	•	•	•	•	Measure inflation pressure with tire gauge. ⇒ P. 12-72
Tie rod ball joint dust boots	Normal condition	•	I:Every 32,000 km (20,000 miles) or 24 months					Check the ball joint dust boots for cracks and wear.
	Severe condition (type (D)~(K))*	•	I:Every 32,000 km (20,000 miles) or 12 months					
SUSPENSION SYSTEM								
Suspension springs		I	•	•	•	•	•	Check for broken springs and tilt of vehicle body toward either side.
Leaf suspension system		•	•	I	•	•	•	Check the leaf spring U-bolts, damage and looseness. Check the leaf springs for cracks and damage, or for displaced leaves. Check the front axle bumper and bump stopper for cracks and damage. Check the shock absorbers for oil leaks.
Stabilizer rod ball joint dust boots <Vehicles with stabilizer>		•	•	I	•	•	•	Check the ball joint dust boots for cracks and wear.

* For about severe conditions, refer to the "For maintenance schedule in severe use". ⇒ P. 15-2

Item		Time of inspection and maintenance						Working procedures
		Pre-operational checks	Inspection interval					
			Every 16,000 km (10,000 miles)	Every 32,000 km (20,000 miles)	Every 48,000 km (30,000 miles)	Every 64,000 km (40,000 miles)	Every 80,000 km (50,000 miles)	
BRAKING SYSTEM								
Service brake pedal			•	•	•	•	•	Make sure that the brake pedal has 0.1 to 3 mm (0.0039 to 0.12 in.) free play when pressed by finger. Check also that when the brake pedal is fully depressed, there is a gap of 10 mm (0.39 in.) or more between the pedal and the floor. ⇒ P. 12-70
Brake performance			•	•	•	•	•	Depress the brake pedal and check that the brakes work effectively and evenly on all wheels. ⇒ P. 12-70
Disc brake pad and disc	Normal condition	•	I:Every 32,000 km (20,000 miles) or 24 months					Check disc brake pad and disc for damage and wear.
	Severe condition (type (D)~(J))*	•	I:Every 32,000 km (20,000 miles) or 12 months					
Brake lining and drum		•	I:Every 32,000 km (20,000 miles) or 12 months					Check lining for wear through inspection hole. Disassemble and check drum for wear, crack and damage.
Parking brake lever stroke			•	•	•	•	•	Check that the parking brake lever stroke is 7 to 9 notches when the lever is pulled with a force of 294 N (66 lbs., 30 kgf). ⇒ P. 12-71

* For about severe conditions, refer to the "For maintenance schedule in severe use". ⇒ P. 15-2

Item		Time of inspection and maintenance					Working procedures	
		Pre-operational checks	Inspection interval					
			Every 16,000 km (10,000 miles)	Every 32,000 km (20,000 miles)	Every 48,000 km (30,000 miles)	Every 64,000 km (40,000 miles)		Every 80,000 km (50,000 miles)
Service brake system	Normal condition	•	I:Every 32,000 km (20,000 miles) or 24 months					Check the brake pedal for play and its clearance to the floor-board when it is pressed all the way. Check the brake system pipes, tubes and hoses for looseness and damage and check for brake fluid leaks. Perform braking tests in a safe place. After checking that warning lamp, is not illuminated, drive the vehicle at a low speed to make sure that braking power is sufficient and even. Check the vacuum hoses for damage. And using FUSO Diagnostics, check the condition of the brake control valve. Inspect brake fluid pressure.
	Severe condition (type (D)~(J))*	•	I:Every 32,000 km (20,000 miles) or 12 months					
STEERING SYSTEM								
Steering wheel free play		I	•	•	•	•	Gently turning the steering wheel, check that its play is more than 10 mm (0.39 in.) and less than 20 mm (0.79 in.). ⇒ P. 12-68	
Steering wheel operation		I	•	•	•	•	Check that the steering wheel does not vibrate or pull to one side and that it is not unduly heavy. Also make sure that the steering wheel returns to its neutral position smoothly. ⇒ P. 12-69	

* For about severe conditions, refer to the "For maintenance schedule in severe use". ⇒ P. 15-2

Item		Time of inspection and maintenance						Working procedures
		Pre-operational checks	Inspection interval					
			Every 16,000 km (10,000 miles)	Every 32,000 km (20,000 miles)	Every 48,000 km (30,000 miles)	Every 64,000 km (40,000 miles)	Every 80,000 km (50,000 miles)	
Steering system		•	•		•	•	•	<p>Check the steering wheel play and looseness. Also drive slowly and check for steering wheel shimmy, pulling, unusually heavy operation, and self-centering motion. Sound the horn and check the volume and tone of its sound. Also, remove the starter key, give the steering wheel half a turn to the left or right, and check whether the steering wheel locks in position and becomes immovable.</p> <p>Check the steering system sections for looseness. Also check for oil leaks from the steering gear box. Check the oil pipe and oil hose connections for looseness, damage and oil leaks. Also check the power steering system operation. Inspect power steering hose damage.</p> <p>⇒ P. 12-68</p>
Drag link ball joint dust boots	Normal condition	•	I:Every 32,000 km (20,000 miles) or 24 months					Check the ball joint dust boots for cracks and wear.
	Severe condition (type (D)~(K))*	•	I:Every 32,000 km (20,000 miles) or 12 months					
ELECTRICAL SYSTEM								
Lighting system			•	•	•	•	•	<p>Make sure that each lamp lights up or flashes properly. Check lamp lenses for dirt and damage.</p> <p>⇒ P. 5-16</p>
Gauge, warning/indicator lamp operation			•	•	•	•	•	<p>Check that gauges, warning lamps and indicators are working properly.</p> <p>⇒ P. 6-2</p>

* For about severe conditions, refer to the "For maintenance schedule in severe use". ⇒ P. 15-2

Item	Time of inspection and maintenance						Working procedures	
	Pre-operational checks	Inspection interval						
		Every 16,000 km (10,000 miles)	Every 32,000 km (20,000 miles)	Every 48,000 km (30,000 miles)	Every 64,000 km (40,000 miles)	Every 80,000 km (50,000 miles)		
Battery fluid level		•	•	•	•	•	Check that the battery fluid level is between the "UPPER" and "LOWER" level lines marked on the sides of the battery case. ⇒  P. 12-91	
OTHERS								
Leak -fuel, oil, coolant and fluid		•	•	•	•	•	Check the underneath of the vehicle for any sign of leakage.	
Chassis frame damage and looseness	•	I:Every 80,000 km (50,000 miles) or 48 months					•	Check the frame, cross member bolts and rivets for cracks, damage and looseness.

3 Lubrication schedule

Ⓔ: Exhaust emission items.

Item	Time of inspection and maintenance						Reference page
	Pre-operational checks	Inspection interval					
		Every 16,000 km (10,000 miles)	Every 32,000 km (20,000 miles)	Every 48,000 km (30,000 miles)	Every 64,000 km (40,000 miles)	Every 80,000 km (50,000 miles)	
Ⓔ Engine oil level		•	•	•	•	•	
Ⓔ Engine oil replacement	Normal condition	•	R:Every 16,000 km (10,000 miles) or 12 months				12-22
	Severe condition (type (A)~(C))*	•	R:Every 8,000 km (5,000 miles)				
Transmission oil replacement	•	•	•	•	R	•	12-30
Clutch control fluid replacement	•	•	•	•	R	•	—

* For about severe conditions, refer to the "For maintenance schedule in severe use". ⇒  P. 15-2

Item		Time of inspection and maintenance						Reference page
		Pre-operational checks	Inspection interval					
			Every 16,000 km (10,000 miles)	Every 32,000 km (20,000 miles)	Every 48,000 km (30,000 miles)	Every 64,000 km (40,000 miles)	Every 80,000 km (50,000 miles)	
Transfer gear oil replacement <FG>		•	•	•	•	R	•	12-33
Rear axle housing gear oil replacement		•	•	•	•	R	•	12-35
Front axle housing gear oil replacement <FG>		•	•	•	•	R	•	
Hub bearing grease replacement (Also replace the oil seal. Remove the front and rear wheel hubs and check for wear and damage of the wheel bearing.	Normal condition	•	R:Every 48,000 km (30,000 miles) or 24 months				-	
	Severe condition (type (D)~(K))*	•	R:Every 48,000 km (30,000 miles) or 12 months					
Front axle bir-field joint grease replacement <FG>	Normal condition	•	R:Every 32,000 km (20,000 miles) or 24 months				-	
	Severe condition (type (D)~(K))*	•	R:Every 32,000 km (20,000 miles) or 12 months					
Front axle king-pin bearing grease replacement <FG>	Normal condition	•	R:Every 32,000 km (20,000 miles) or 24 months				-	
	Severe condition (type (D)~(K))*	•	R:Every 32,000 km (20,000 miles) or 12 months					
Front axle steering knuckle grease replacement <FG>	Normal condition	•	R:Every 32,000 km (20,000 miles) or 24 months				-	
	Severe condition (type (D)~(K))*	•	R:Every 32,000 km (20,000 miles) or 12 months					

* For about severe conditions, refer to the "For maintenance schedule in severe use". ⇨  P. 15-2

Item		Time of inspection and maintenance					Reference page	
		Pre-operational checks	Inspection interval					
			Every 16,000 km (10,000 miles)	Every 32,000 km (20,000 miles)	Every 48,000 km (30,000 miles)	Every 64,000 km (40,000 miles)		Every 80,000 km (50,000 miles)
Brake fluid level			•	•	•	•	•	12-39
Brake fluid replacement		•	R:Every 24 months					–
Power steering fluid replacement		•	R:Every 32,000 km (20,000 miles) or 12 months					–
Lubrication of propeller shaft	Universal joint, slip joint	•	L:Every 32,000 km (20,000 miles) or 24 months					12-18
	Double cardan joint <FG>	•	L:Every 32,000 km (20,000 miles) or 24 months					12-18
Lubrication of rear suspension spring pin		•	L:Every 32,000 km (20,000 miles) or 24 months					12-18
Lubrication of kingpins	Normal condition	•	L:Every 32,000 km (20,000 miles) or 24 months					
	Severe condition (type (D)~(K))*	•	L:Every 32,000 km (20,000 miles) or 12 months					
Lubrication of door hinge		•	L:Every 80,000 km (50,000 miles) or 48 months					12-22
Lubrication of anchor hook <Vehicles other than Crew-cab mod- els>		•	L:Every 80,000 km (50,000 miles) or 48 months					12-22

* For about severe conditions, refer to the "For maintenance schedule in severe use". ⇨ P. 15-2

16. ALPHABETICAL INDEX

4WD operation <FG models>	8-1	Engine immobilizer starter key	3-3
Accelerator pedal	5-14	Engine number	1-2
Air cleaner	12-52	Engine oil	11-2, 12-22
Air conditioner	9-4, 9-10	Engine overheats	13-8
Air filters	12-94	Entering and exiting the vehicle	3-13
AM/FM radio & CD player	10-12	Exhaust brake	5-18
Antilock braking system (ABS)	7-9	Free-wheeling hub	8-5
Ashtrays	10-3	Front air outlets	9-2
Assistant driver's seat	4-4	Front drive switch	8-3
Axle housing gear oil	12-35	Front fog lamp switch	5-45
Battery	12-90	Fuel filter	12-45
Battery has discharged	13-29	Fuel gauge	6-4
BlueTec [®] system	5-50	Fuels	1-5, 11-2
Brake fluid	12-37	Fuse	13-10
Brake pedal	5-14	Greasing	12-18
Brakes	12-69	Hazard warning lamp switch	5-44
Braking	7-8, 13-28	Heated mirror switch	5-46
Chassis number	1-2	Horn switch	5-47
Cigarette lighter	10-2	Idle limiting system	5-67
Cleaning your vehicle	12-95	If fuel tank becomes empty	13-31
Clutch control fluid	12-30	Indicator lamps	6-28
Clutch control fluid filter	12-51	Interior lamp	10-5
Coat hooks	10-4	Jacking points	12-76
Combination switch	5-16	Lamp	13-18
Coolant	11-2, 12-57	Lane changer	5-17
Coolant temperature gauge	6-3	Lighting switch	5-16
Cruise control	5-38	Limited slip differential	7-18
Cup holder	10-9	Loading cargo	7-20
DEF level indicator	6-5	Lubrication	12-17
Diesel exhaust fluid (DEF)	1-8	Maintenance record	17-1
Dimmer switch	5-17	Maintenance schedule	15-1
Door locks	3-8	Obtaining service	1-14
Door window glass	3-15	Oil filter	12-41
Doors	3-6	On rough roads and in bad weather ...	7-14
Draining water from fuel filter	12-56	On uphill and downhill roads	7-12
Driver's seat	4-2	Parking	7-16
Driving precautions	7-3	Parking brake	12-71
DUONIC [®]	5-21	Parking brake lever	5-15

Passing signal	5-17	Vehicle service specification	14-4
Periodic inspection	1-4	Warming up the engine	5-10
Possible causes and solutions	13-2	Warning labels	2-1
Power steering fluid	12-40	Warning lamps	6-28
Power window switches	3-15	Washer switch	5-19
Precautions while shifting the vehicle into gear	7-2	Wheel nuts	12-84
Pre-operational check	1-4, 12-12	Windshield washer	12-89
Rear air outlets	9-3	Wiper blade	12-88
Rear heater	9-16	Wiper switch	5-19
Recommended lubricants	14-2, 14-3		
Recording, storing, and handling of the vehicle data	1-13		
Reporting safety defects	1-14		
Seat belts	4-5		
Seats	4-2		
Small article compartments	10-7		
Starter key	3-2		
Starter switch	5-3		
Starting the engine	5-5		
Steering wheel	4-9		
Step lamp	10-6		
Stopping the engine	5-12		
Sun visors	10-4		
Tachometer	6-2		
Tilting the cab	12-6		
Tips for improving fuel economy	7-7		
Tire chains	11-6		
Tire replacement	12-75		
Tire rotation	12-86		
Tires	12-72		
Towing	13-32		
Transmission gear oil	12-30		
Transmission PTO	5-47		
Turn signal lamp switch	5-17		
Van body dome light switch	5-45		
V-belts	12-66		
Vehicle identification number (VIN)	1-3		

17. MAINTENANCE RECORD

NOTE:

- The symbols ④ and ④ prefixed to some check items stand for Exhaust Emission Control item and Noise Control item respectively.
- The latter half of the maintenance record contains the maintenance record sheets used for periodic maintenance scheduled by time (months).

8,000 km / 5,000 miles
SERVICE OPERATIONS

Owner's name: _____

Date: _____

Address: _____

Total mileage: _____

Servicing dealer's name: _____

Address: _____

Signature: _____

8,000 km / 5,000 miles
SERVICE OPERATIONS

Owner's name: _____ Date: _____

Address: _____

Vehicle identification number: _____

Lubrication

⑤ Engine oil replacement *

*: If your vehicle use situation corresponds to one of the severe condition type (A)~(C), perform inspection or replacement according to this maintenance schedule.

⇒  P. 15-2

**16,000 km / 10,000 miles
SERVICE OPERATIONS**

Owner's name: _____

Date: _____

Address: _____

Total mileage: _____

Servicing dealer's name: _____

Address: _____

Signature: _____

**16,000 km / 10,000 miles
SERVICE OPERATIONS**

Owner's name: _____ Date: _____

Address: _____

Vehicle identification number: _____

Lubrication

- Ⓔ Engine oil replacement (or every 12 months)

Inspection and maintenance

Engine

- Ⓔ Oil filter replacement (or every 12 months)

24,000 km / 15,000 miles
SERVICE OPERATIONS

Owner's name: _____

Date: _____

Address: _____

Total mileage: _____

Servicing dealer's name: _____

Address: _____

Signature: _____

24,000 km / 15,000 miles
SERVICE OPERATIONS

Owner's name: _____ Date: _____

Address: _____

Vehicle identification number: _____

Lubrication

㊦ Engine oil replacement *

*: If your vehicle use situation corresponds to one of the severe condition type (A)~(C), perform inspection or replacement according to this maintenance schedule.

⇒  P. 15-2

32,000 km / 20,000 miles
SERVICE OPERATIONS

Owner's name: _____

Date: _____

Address: _____

Total mileage: _____

Servicing dealer's name: _____

Address: _____

Signature: _____

32,000 km / 20,000 miles
SERVICE OPERATIONS

Owner's name: _____ Date: _____

Address: _____

Vehicle identification number: _____

Lubrication

- ⑤ Engine oil replacement (or every 12 months)
- Front axle birfield joint grease replacement <FG> (or every 24 months (every 12 months *))
- Front axle kingpin bearing grease replacement <FG> (or every 24 months (every 12 months *))
- Front axle steering knuckle grease replacement <FG> (or every 24 months (every 12 months *))
- Power steering fluid replacement (or every 12 months)
- Lubrication of universal joints, slip joint (or every 24 months)
- Lubrication of double cardan joint <FG> (or every 24 months)
- Lubrication of rear suspension spring pin (or every 24 months)
- Lubrication of king pins (or every 24 months (every 12 months *))

*: If your vehicle use situation corresponds to one of the severe condition type (D)~(K), perform inspection or replacement according to this maintenance schedule.

⇒  P. 15-2

Inspection and maintenance

Engine

- ⑤ Oil filter replacement (or every 12 months)
- ⑤ Fuel filter replacement (or every 12 months)
- ⑤⑨ V-belts tension and damage (or every 12 months)
- ⑤⑨ Alternator (or every 12 months)
- ⑤ Cooling system (or every 12 months)
- ⑤⑨ Air cleaner element replacement
- ⑤⑨ Exhaust system (or every 12 months)
- ⑤ DPF (or every 12 months)
- ⑤ DEF line leakage and damage (or every 12 months)

Power train

- Propeller shaft flange torque and universal joint looseness

Front and rear axle

- Tie rod ball joint dust boots (or every 24 months (every 12 months *1))

Suspension system

- Leaf suspension system
- Stabilizer rod ball joint dust boots <Vehicles with stabilizer>

Braking system

- Disc brake pad and disc (or every 24 months (every 12 months *2))
- Brake lining and drum (or every 12 months)
- Service brake system (or every 24 months (every 12 months *2))

Steering system

- Steering system
- Drag link ball joint dust boots (or every 24 months (every 12 months *1))

*1: If your vehicle use situation corresponds to one of the severe condition type (D)~(K), perform inspection or replacement according to this maintenance schedule.

*2: If your vehicle use situation corresponds to one of the severe condition type (D)~(J), perform inspection or replacement according to this maintenance schedule.

⇒  P. 15-2

40,000 km / 25,000 miles
SERVICE OPERATIONS

Owner's name: _____

Date: _____

Address: _____

Total mileage: _____

Servicing dealer's name: _____

Address: _____

Signature: _____

40,000 km / 25,000 miles
SERVICE OPERATIONS

Owner's name: _____ Date: _____

Address: _____

Vehicle identification number: _____

Lubrication

 Engine oil replacement *

*: If your vehicle use situation corresponds to one of the severe condition type (A)~(C), perform inspection or replacement according to this maintenance schedule.

⇒  P. 15-2

48,000 km / 30,000 miles
SERVICE OPERATIONS

Owner's name: _____

Date: _____

Address: _____

Total mileage: _____

Servicing dealer's name: _____

Address: _____

Signature: _____

48,000 km / 30,000 miles
SERVICE OPERATIONS

Owner's name: _____ Date: _____

Address: _____

Vehicle identification number: _____

Lubrication

- ㊦ Engine oil replacement (or every 12 months)
- ㊦ Hub bearing grease replacement (or every 24 months (every 12 months *))

*: If your vehicle use situation corresponds to one of the severe condition type (D)~(K), perform inspection or replacement according to this maintenance schedule.

⇒  P. 15-2

Inspection and maintenance

Engine

- ㊦ Oil filter replacement (or every 12 months)
- ㊦ PCV filter replacement (or every 36 months)

56,000 km / 35,000 miles
SERVICE OPERATIONS

Owner's name: _____

Date: _____

Address: _____

Total mileage: _____

Servicing dealer's name: _____

Address: _____

Signature: _____

56,000 km / 35,000 miles
SERVICE OPERATIONS

Owner's name: _____ Date: _____

Address: _____

Vehicle identification number: _____

Lubrication

Ⓔ Engine oil replacement *

*: If your vehicle use situation corresponds to one of the severe condition type (A)~(C), perform inspection or replacement according to this maintenance schedule.

⇒  P. 15-2

64,000 km / 40,000 miles
SERVICE OPERATIONS

Owner's name: _____

Date: _____

Address: _____

Total mileage: _____

Servicing dealer's name: _____

Address: _____

Signature: _____

64,000 km / 40,000 miles
SERVICE OPERATIONS

Owner's name: _____ Date: _____

Address: _____

Vehicle identification number: _____

Lubrication

- Ⓔ Engine oil replacement (or every 12 months)
- Transmission oil replacement
- Clutch control fluid replacement
- Transfer gear oil replacement <FG>
- Rear axle housing gear oil replacement
- Front axle housing gear oil replacement <FG>
- Front axle birfield joint grease replacement <FG> (or every 24 months (every 12 months *))
- Front axle kingpin bearing grease replacement <FG> (or every 24 months (every 12 months *))
- Front axle steering knuckle grease replacement <FG> (or every 24 months (every 12 months *))
- Power steering fluid replacement (or every 12 months)
- Lubrication of universal joints, slip joint (or every 24 months)
- Lubrication of double cardan joint <FG> (or every 24 months)
- Lubrication of rear suspension spring pin (or every 24 months)
- Lubrication of king pins (or every 24 months (every 12 months *))

*: If your vehicle use situation corresponds to one of the severe condition type (D)~(K), perform inspection or replacement according to this maintenance schedule.

⇒  P. 15-2

Inspection and maintenance

Engine

- ④ Oil filter replacement (or every 12 months)
- ④ Fuel filter replacement (or every 12 months)
- ④⑨ V-belts tension and damage (or every 12 months)
- ④⑨ Alternator (or every 12 months)
- ④ Cooling system (or every 12 months)
- ④⑨ Air cleaner element replacement
- ④⑨ Exhaust system (or every 12 months)
- ④ DPF (or every 12 months)
- ④ DEF line leakage and damage (or every 12 months)

Power train

- Clutch control fluid filter replacement
- Propeller shaft flange torque and universal joint looseness

Front and rear axle

- Tie rod ball joint dust boots (or every 24 months (every 12 months *1))

Suspension system

- Leaf suspension system
- Stabilizer rod ball joint dust boots <Vehicles with stabilizer>

Braking system

- Disc brake pad and disc (or every 24 months (every 12 months *2))
- Brake lining and drum (or every 12 months)
- Service brake system (or every 24 months (every 12 months *2))

Steering system

- Steering system
- Drag link ball joint dust boots (or every 24 months (every 12 months *1))

*1: If your vehicle use situation corresponds to one of the severe condition type (D)~(K), perform inspection or replacement according to this maintenance schedule.

*2: If your vehicle use situation corresponds to one of the severe condition type (D)~(J), perform inspection or replacement according to this maintenance schedule.

⇒  P. 15-2

72,000 km / 45,000 miles
SERVICE OPERATIONS

Owner's name: _____

Date: _____

Address: _____

Total mileage: _____

Servicing dealer's name: _____

Address: _____

Signature: _____

72,000 km / 45,000 miles
SERVICE OPERATIONS

Owner's name: _____ Date: _____

Address: _____

Vehicle identification number: _____

Lubrication

⑤ Engine oil replacement *

*: If your vehicle use situation corresponds to one of the severe condition type (A)~(C), perform inspection or replacement according to this maintenance schedule.

⇒  P. 15-2

80,000 km / 50,000 miles
SERVICE OPERATIONS

Owner's name: _____

Date: _____

Address: _____

Total mileage: _____

Servicing dealer's name: _____

Address: _____

Signature: _____

80,000 km / 50,000 miles
SERVICE OPERATIONS

Owner's name: _____ Date: _____

Address: _____

Vehicle identification number: _____

Lubrication

- Ⓔ Engine oil replacement (or every 12 months)
- Lubrication of door hinge (or every 48 months)
- Lubrication of anchor hook (or every 48 months) <Vehicles other than Crew-cab models>

Inspection and maintenance

Engine

- Ⓔ Oil filter replacement (or every 12 months)

Power train

- Propeller shaft center bearing

Others

- Chassis frame damage and looseness (or every 48 months)

88,000 km / 55,000 miles
SERVICE OPERATIONS

Owner's name: _____

Date: _____

Address: _____

Total mileage: _____

Servicing dealer's name: _____

Address: _____

Signature: _____

88,000 km / 55,000 miles
SERVICE OPERATIONS

Owner's name: _____ Date: _____

Address: _____

Vehicle identification number: _____

Lubrication

⑤ Engine oil replacement *

*: If your vehicle use situation corresponds to one of the severe condition type (A)~(C), perform inspection or replacement according to this maintenance schedule.

⇒  P. 15-2

96,000 km / 60,000 miles
SERVICE OPERATIONS

Owner's name: _____

Date: _____

Address: _____

Total mileage: _____

Servicing dealer's name: _____

Address: _____

Signature: _____

96,000 km / 60,000 miles
SERVICE OPERATIONS

Owner's name: _____ Date: _____

Address: _____

Vehicle identification number: _____

Lubrication

- ⑤ Engine oil replacement (or every 12 months)
- Hub bearing grease replacement (or every 24 months (every 12 months *))
- Front axle birfield joint grease replacement <FG> (or every 24 months (every 12 months *))
- Front axle kingpin bearing grease replacement <FG> (or every 24 months (every 12 months *))
- Front axle steering knuckle grease replacement <FG> (or every 24 months (every 12 months *))
- Power steering fluid replacement (or every 12 months)
- Lubrication of universal joints, slip joint (or every 24 months)
- Lubrication of double cardan joint <FG> (or every 24 months)
- Lubrication of rear suspension spring pin (or every 24 months)
- Lubrication of king pins (or every 24 months (every 12 months *))

*: If your vehicle use situation corresponds to one of the severe condition type (D)~(K), perform inspection or replacement according to this maintenance schedule.

⇒  P. 15-2

Inspection and maintenance

Engine

- ⑤ Oil filter replacement (or every 12 months)
- ⑤ Fuel filter replacement (or every 12 months)
- ⑤ PCV filter replacement (or every 36 months)
- ⑤⑨ V-belts tension and damage (or every 12 months)
- ⑤⑨ Alternator (or every 12 months)
- ⑤ Cooling system (or every 12 months)
- ⑤⑨ Air cleaner element replacement
- ⑤⑨ Exhaust system (or every 12 months)
- ⑤ DPF (or every 12 months)
- ⑤ DEF line leakage and damage (or every 12 months)

Power train

- Propeller shaft flange torque and universal joint looseness

Front and rear axle

- Tie rod ball joint dust boots (or every 24 months (every 12 months *1))

Suspension system

- Leaf suspension system
- Stabilizer rod ball joint dust boots <Vehicles with stabilizer>

Braking system

- Disc brake pad and disc (or every 24 months (every 12 months *2))
- Brake lining and drum (or every 12 months)
- Service brake system (or every 24 months (every 12 months *2))

Steering system

- Steering system
- Drag link ball joint dust boots (or every 24 months (every 12 months *1))

*1: If your vehicle use situation corresponds to one of the severe condition type (D)~(K), perform inspection or replacement according to this maintenance schedule.

*2: If your vehicle use situation corresponds to one of the severe condition type (D)~(J), perform inspection or replacement according to this maintenance schedule.

⇒  P. 15-2

104,000 km / 65,000 miles
SERVICE OPERATIONS

Owner's name: _____

Date: _____

Address: _____

Total mileage: _____

Servicing dealer's name: _____

Address: _____

Signature: _____

104,000 km / 65,000 miles
SERVICE OPERATIONS

Owner's name: _____ Date: _____

Address: _____

Vehicle identification number: _____

Lubrication

 Engine oil replacement *

*: If your vehicle use situation corresponds to one of the severe condition type (A)~(C), perform inspection or replacement according to this maintenance schedule.

⇒  P. 15-2

112,000 km / 70,000 miles
SERVICE OPERATIONS

Owner's name: _____

Date: _____

Address: _____

Total mileage: _____

Servicing dealer's name: _____

Address: _____

Signature: _____

112,000 km / 70,000 miles
SERVICE OPERATIONS

Owner's name: _____ Date: _____

Address: _____

Vehicle identification number: _____

Lubrication

- Ⓔ Engine oil replacement (or every 12 months)

Inspection and maintenance

Engine

- Ⓔ Oil filter replacement (or every 12 months)

120,000 km / 75,000 miles
SERVICE OPERATIONS

Owner's name: _____

Date: _____

Address: _____

Total mileage: _____

Servicing dealer's name: _____

Address: _____

Signature: _____

120,000 km / 75,000 miles
SERVICE OPERATIONS

Owner's name: _____ Date: _____

Address: _____

Vehicle identification number: _____

Lubrication

 Engine oil replacement *

*: If your vehicle use situation corresponds to one of the severe condition type (A)~(C), perform inspection or replacement according to this maintenance schedule.

⇒  P. 15-2

128,000 km / 80,000 miles
SERVICE OPERATIONS

Owner's name: _____

Date: _____

Address: _____

Total mileage: _____

Servicing dealer's name: _____

Address: _____

Signature: _____

128,000 km / 80,000 miles
SERVICE OPERATIONS

Owner's name: _____ Date: _____

Address: _____

Vehicle identification number: _____

Lubrication

- ① Engine oil replacement (or every 12 months)
- Transmission oil replacement
- Clutch control fluid replacement
- Transfer gear oil replacement <FG>
- Rear axle housing gear oil replacement
- Front axle housing gear oil replacement <FG>
- Front axle birfield joint grease replacement <FG> (or every 24 months (every 12 months *))
- Front axle kingpin bearing grease replacement <FG> (or every 24 months (every 12 months *))
- Front axle steering knuckle grease replacement <FG> (or every 24 months (every 12 months *))
- Power steering fluid replacement (or every 12 months)
- Lubrication of universal joints, slip joint (or every 24 months)
- Lubrication of double cardan joint <FG> (or every 24 months)
- Lubrication of rear suspension spring pin (or every 24 months)
- Lubrication of king pins (or every 24 months (every 12 months *))

*: If your vehicle use situation corresponds to one of the severe condition type (D)~(K), perform inspection or replacement according to this maintenance schedule.

⇒  P. 15-2

Inspection and maintenance

Engine

- ⑤ Oil filter replacement (or every 12 months)
- ⑤ Fuel filter replacement (or every 12 months)
- ⑤⑨ V-belts tension and damage (or every 12 months)
- ⑤⑨ Alternator (or every 12 months)
- ⑤ Cooling system (or every 12 months)
- ⑤⑨ Air cleaner element replacement
- ⑤⑨ Exhaust system (or every 12 months)
- ⑤ DPF (or every 12 months)
- ⑤ DEF line leakage and damage (or every 12 months)

Power train

- Clutch control fluid filter replacement
- Propeller shaft flange torque and universal joint looseness

Front and rear axle

- Tie rod ball joint dust boots (or every 24 months (every 12 months *1))

Suspension system

- Leaf suspension system
- Stabilizer rod ball joint dust boots <Vehicles with stabilizer>

Braking system

- Disc brake pad and disc (or every 24 months (every 12 months *2))
- Brake lining and drum (or every 12 months)
- Service brake system (or every 24 months (every 12 months *2))

Steering system

- Steering system
- Drag link ball joint dust boots (or every 24 months (every 12 months *1))

*1: If your vehicle use situation corresponds to one of the severe condition type (D)~(K), perform inspection or replacement according to this maintenance schedule.

*2: If your vehicle use situation corresponds to one of the severe condition type (D)~(J), perform inspection or replacement according to this maintenance schedule.

⇒  P. 15-2

136,000 km / 85,000 miles
SERVICE OPERATIONS

Owner's name: _____

Date: _____

Address: _____

Total mileage: _____

Servicing dealer's name: _____

Address: _____

Signature: _____

136,000 km / 85,000 miles
SERVICE OPERATIONS

Owner's name: _____ Date: _____

Address: _____

Vehicle identification number: _____

Lubrication

⑤ Engine oil replacement *

*: If your vehicle use situation corresponds to one of the severe condition type (A)~(C), perform inspection or replacement according to this maintenance schedule.

⇒  P. 15-2

144,000 km / 90,000 miles
SERVICE OPERATIONS

Owner's name: _____

Date: _____

Address: _____

Total mileage: _____

Servicing dealer's name: _____

Address: _____

Signature: _____

144,000 km / 90,000 miles
SERVICE OPERATIONS

Owner's name: _____ Date: _____

Address: _____

Vehicle identification number: _____

Lubrication

- ㊦ Engine oil replacement (or every 12 months)
- ㊦ Hub bearing grease replacement (or every 24 months (every 12 months *))

*: If your vehicle use situation corresponds to one of the severe condition type (D)~(K), perform inspection or replacement according to this maintenance schedule.

⇒  P. 15-2

Inspection and maintenance

Engine

- ㊦ Oil filter replacement (or every 12 months)
- ㊦ PCV filter replacement (or every 36 months)

152,000 km / 95,000 miles
SERVICE OPERATIONS

Owner's name: _____

Date: _____

Address: _____

Total mileage: _____

Servicing dealer's name: _____

Address: _____

Signature: _____

152,000 km / 95,000 miles
SERVICE OPERATIONS

Owner's name: _____ Date: _____

Address: _____

Vehicle identification number: _____

Lubrication

⑤ Engine oil replacement *

*: If your vehicle use situation corresponds to one of the severe condition type (A)~(C), perform inspection or replacement according to this maintenance schedule.

⇒  P. 15-2

160,000 km / 100,000 miles
SERVICE OPERATIONS

Owner's name: _____

Date: _____

Address: _____

Total mileage: _____

Servicing dealer's name: _____

Address: _____

Signature: _____

160,000 km / 100,000 miles
SERVICE OPERATIONS

Owner's name: _____ Date: _____

Address: _____

Vehicle identification number: _____

Lubrication

- ④ Engine oil replacement (or every 12 months)
- Front axle birfield joint grease replacement <FG> (or every 24 months (every 12 months *))
- Front axle kingpin bearing grease replacement <FG> (or every 24 months (every 12 months *))
- Front axle steering knuckle grease replacement <FG> (or every 24 months (every 12 months *))
- Power steering fluid replacement (or every 12 months)
- Lubrication of universal joints, slip joint (or every 24 months)
- Lubrication of double cardan joint <FG> (or every 24 months)
- Lubrication of rear suspension spring pin (or every 24 months)
- Lubrication of king pins (or every 24 months (every 12 months *))
- Lubrication of door hinge (or every 48 months)
- Lubrication of anchor hook (or every 48 months) <Vehicles other than Crew-cab models>

*: If your vehicle use situation corresponds to one of the severe condition type (D)~(K), perform inspection or replacement according to this maintenance schedule.

⇒  P. 15-2

Inspection and maintenance

Engine

- ⑤ Oil filter replacement (or every 12 months)
- ⑤ Fuel filter replacement (or every 12 months)
- ⑤⑨ V-belts tension and damage (or every 12 months)
- ⑤⑨ Alternator (or every 12 months)
- ⑤ Cooling system (or every 12 months)
- ⑤⑨ Air cleaner element replacement
- ⑤⑨ Exhaust system (or every 12 months)
- ⑤ DPF (or every 12 months)
- ⑤ DEF line leakage and damage (or every 12 months)

Power train

- Propeller shaft flange torque and universal joint looseness
- Propeller shaft center bearing

Front and rear axle

- Tie rod ball joint dust boots (or every 24 months (every 12 months *1))

Suspension system

- Leaf suspension system
- Stabilizer rod ball joint dust boots <Vehicles with stabilizer>

Braking system

- Disc brake pad and disc (or every 24 months (every 12 months *2))
- Brake lining and drum (or every 12 months)
- Service brake system (or every 24 months (every 12 months *2))

Steering system

- Steering system
- Drag link ball joint dust boots (or every 24 months (every 12 months *1))

Others

- Chassis frame damage and looseness (or every 48 months)

*1: If your vehicle use situation corresponds to one of the severe condition type (D)~(K), perform inspection or replacement according to this maintenance schedule.

*2: If your vehicle use situation corresponds to one of the severe condition type (D)~(J), perform inspection or replacement according to this maintenance schedule.

⇒  P. 15-2

168,000 km / 105,000 miles
SERVICE OPERATIONS

Owner's name: _____

Date: _____

Address: _____

Total mileage: _____

Servicing dealer's name: _____

Address: _____

Signature: _____

168,000 km / 105,000 miles
SERVICE OPERATIONS

Owner's name: _____ Date: _____

Address: _____

Vehicle identification number: _____

Lubrication

⑤ Engine oil replacement *

*: If your vehicle use situation corresponds to one of the severe condition type (A)~(C), perform inspection or replacement according to this maintenance schedule.

⇒  P. 15-2

176,000 km / 110,000 miles
SERVICE OPERATIONS

Owner's name: _____

Date: _____

Address: _____

Total mileage: _____

Servicing dealer's name: _____

Address: _____

Signature: _____

176,000 km / 110,000 miles
SERVICE OPERATIONS

Owner's name: _____ Date: _____

Address: _____

Vehicle identification number: _____

Lubrication

- Ⓔ Engine oil replacement (or every 12 months)

Inspection and maintenance

Engine

- Ⓔ Oil filter replacement (or every 12 months)

184,000 km / 115,000 miles
SERVICE OPERATIONS

Owner's name: _____

Date: _____

Address: _____

Total mileage: _____

Servicing dealer's name: _____

Address: _____

Signature: _____

184,000 km / 115,000 miles
SERVICE OPERATIONS

Owner's name: _____ Date: _____

Address: _____

Vehicle identification number: _____

Lubrication

 Engine oil replacement *

*: If your vehicle use situation corresponds to one of the severe condition type (A)~(C), perform inspection or replacement according to this maintenance schedule.

⇒  P. 15-2

192,000 km / 120,000 miles
SERVICE OPERATIONS

Owner's name: _____

Date: _____

Address: _____

Total mileage: _____

Servicing dealer's name: _____

Address: _____

Signature: _____

192,000 km / 120,000 miles
SERVICE OPERATIONS

Owner's name: _____ Date: _____

Address: _____

Vehicle identification number: _____

Lubrication

- Ⓔ Engine oil replacement (or every 12 months)
- Transmission oil replacement
- Clutch control fluid replacement
- Transfer gear oil replacement <FG>
- Rear axle housing gear oil replacement
- Front axle housing gear oil replacement <FG>
- Hub bearing grease replacement (or every 24 months (every 12 months *))
- Front axle birfield joint grease replacement <FG> (or every 24 months (every 12 months *))
- Front axle kingpin bearing grease replacement <FG> (or every 24 months (every 12 months *))
- Front axle steering knuckle grease replacement <FG> (or every 24 months (every 12 months *))
- Power steering fluid replacement (or every 12 months)
- Lubrication of universal joints, slip joint (or every 24 months)
- Lubrication of double cardan joint <FG> (or every 24 months)
- Lubrication of rear suspension spring pin (or every 24 months)
- Lubrication of king pins (or every 24 months (every 12 months *))

*: If your vehicle use situation corresponds to one of the severe condition type (D)~(K), perform inspection or replacement according to this maintenance schedule.

⇒  P. 15-2

Inspection and maintenance

Engine

- Ⓔ Oil filter replacement (or every 12 months)
- Ⓔ Fuel filter replacement (or every 12 months)
- Ⓔ PCV filter replacement (or every 36 months)
- ⒺⓃ V-belts tension and damage (or every 12 months)
- ⒺⓃ Alternator (or every 12 months)
- Ⓔ Cooling system (or every 12 months)
- ⒺⓃ Air cleaner element replacement
- ⒺⓃ Exhaust system (or every 12 months)
- Ⓔ DPF (or every 12 months)
- Ⓔ DEF line leakage and damage (or every 12 months)

Power train

- Clutch control fluid filter replacement
- Propeller shaft flange torque and universal joint looseness
- Propeller shaft bearing kit (or every 120 months)

Front and rear axle

- Tie rod ball joint dust boots (or every 24 months (every 12 months *1))

Suspension system

- Leaf suspension system
- Stabilizer rod ball joint dust boots <Vehicles with stabilizer>

Braking system

- Disc brake pad and disc (or every 24 months (every 12 months *2))
- Brake lining and drum (or every 12 months)
- Service brake system (or every 24 months (every 12 months *2))

Steering system

- Steering system
- Drag link ball joint dust boots (or every 24 months (every 12 months *1))

*1: If your vehicle use situation corresponds to one of the severe condition type (D)~(K), perform inspection or replacement according to this maintenance schedule.

*2: If your vehicle use situation corresponds to one of the severe condition type (D)~(J), perform inspection or replacement according to this maintenance schedule.

⇒  P. 15-2

200,000 km / 125,000 miles
SERVICE OPERATIONS

Owner's name: _____

Date: _____

Address: _____

Total mileage: _____

Servicing dealer's name: _____

Address: _____

Signature: _____

200,000 km / 125,000 miles
SERVICE OPERATIONS

Owner's name: _____ Date: _____

Address: _____

Vehicle identification number: _____

Lubrication

㊦ Engine oil replacement *

*: If your vehicle use situation corresponds to one of the severe condition type (A)~(C), perform inspection or replacement according to this maintenance schedule.

⇒  P. 15-2

208,000 km / 130,000 miles
SERVICE OPERATIONS

Owner's name: _____

Date: _____

Address: _____

Total mileage: _____

Servicing dealer's name: _____

Address: _____

Signature: _____

208,000 km / 130,000 miles
SERVICE OPERATIONS

Owner's name: _____ Date: _____

Address: _____

Vehicle identification number: _____

Lubrication

- Ⓔ Engine oil replacement (or every 12 months)

Inspection and maintenance

Engine

- Ⓔ Oil filter replacement (or every 12 months)

216,000 km / 135,000 miles
SERVICE OPERATIONS

Owner's name: _____

Date: _____

Address: _____

Total mileage: _____

Servicing dealer's name: _____

Address: _____

Signature: _____

216,000 km / 135,000 miles
SERVICE OPERATIONS

Owner's name: _____ Date: _____

Address: _____

Vehicle identification number: _____

Lubrication

㊦ Engine oil replacement *

*: If your vehicle use situation corresponds to one of the severe condition type (A)~(C), perform inspection or replacement according to this maintenance schedule.

⇒  P. 15-2

224,000 km / 140,000 miles
SERVICE OPERATIONS

Owner's name: _____

Date: _____

Address: _____

Total mileage: _____

Servicing dealer's name: _____

Address: _____

Signature: _____

224,000 km / 140,000 miles
SERVICE OPERATIONS

Owner's name: _____ Date: _____

Address: _____

Vehicle identification number: _____

Lubrication

- ⑤ Engine oil replacement (or every 12 months)
- Front axle birfield joint grease replacement <FG> (or every 24 months (every 12 months *))
- Front axle kingpin bearing grease replacement <FG> (or every 24 months (every 12 months *))
- Front axle steering knuckle grease replacement <FG> (or every 24 months (every 12 months *))
- Power steering fluid replacement (or every 12 months)
- Lubrication of universal joints, slip joint (or every 24 months)
- Lubrication of double cardan joint <FG> (or every 24 months)
- Lubrication of rear suspension spring pin (or every 24 months)
- Lubrication of king pins (or every 24 months (every 12 months *))

*: If your vehicle use situation corresponds to one of the severe condition type (D)~(K), perform inspection or replacement according to this maintenance schedule.

⇒  P. 15-2

Inspection and maintenance

Engine

- ④ Oil filter replacement (or every 12 months)
- ④ Fuel filter replacement (or every 12 months)
- ④⑨ V-belts tension and damage (or every 12 months)
- ④⑨ Alternator (or every 12 months)
- ④ Cooling system (or every 12 months)
- ④⑨ Air cleaner element replacement
- ④⑨ Exhaust system (or every 12 months)
- ④ DPF (or every 12 months)
- ④ DEF line leakage and damage (or every 12 months)
- ④⑨ Alternator tensioner replacement (or every 72 months)
- Glow plug replacement (or every 72 months)

Power train

- Propeller shaft flange torque and universal joint looseness

Front and rear axle

- Tie rod ball joint dust boots (or every 24 months (every 12 months *1))

Suspension system

- Leaf suspension system
- Stabilizer rod ball joint dust boots <Vehicles with stabilizer>

Braking system

- Disc brake pad and disc (or every 24 months (every 12 months *2))
- Brake lining and drum (or every 12 months)
- Service brake system (or every 24 months (every 12 months *2))

Steering system

- Steering system
- Drag link ball joint dust boots (or every 24 months (every 12 months *1))

*1: If your vehicle use situation corresponds to one of the severe condition type (D)~(K), perform inspection or replacement according to this maintenance schedule.

*2: If your vehicle use situation corresponds to one of the severe condition type (D)~(J), perform inspection or replacement according to this maintenance schedule.

⇒  P. 15-2

232,000 km / 145,000 miles
SERVICE OPERATIONS

Owner's name: _____

Date: _____

Address: _____

Total mileage: _____

Servicing dealer's name: _____

Address: _____

Signature: _____

232,000 km / 145,000 miles
SERVICE OPERATIONS

Owner's name: _____ Date: _____

Address: _____

Vehicle identification number: _____

Lubrication

⑤ Engine oil replacement *

*: If your vehicle use situation corresponds to one of the severe condition type (A)~(C), perform inspection or replacement according to this maintenance schedule..

⇒  P. 15-2

240,000 km / 150,000 miles
SERVICE OPERATIONS

Owner's name: _____

Date: _____

Address: _____

Total mileage: _____

Servicing dealer's name: _____

Address: _____

Signature: _____

240,000 km / 150,000 miles
SERVICE OPERATIONS

Owner's name: _____ Date: _____

Address: _____

Vehicle identification number: _____

Lubrication

- ⑤ Engine oil replacement (or every 12 months)
- Hub bearing grease replacement (or every 24 months (every 12 months *))
- Lubrication of door hinge (or every 48 months)
- Lubrication of anchor hook (or every 48 months) <Vehicles other than Crew-cab models>

*: If your vehicle use situation corresponds to one of the severe condition type (D)~(K), perform inspection or replacement according to this maintenance schedule.

⇒  P. 15-2

Inspection and maintenance

Engine

- ⑤ Oil filter replacement (or every 12 months)
- ⑤ PCV filter replacement (or every 36 months)

POWER TRAIN

- Propeller shaft center bearing

Others

- Chassis frame damage and looseness (or every 48 months)

248,000 km / 155,000 miles
SERVICE OPERATIONS

Owner's name: _____

Date: _____

Address: _____

Total mileage: _____

Servicing dealer's name: _____

Address: _____

Signature: _____

248,000 km / 155,000 miles
SERVICE OPERATIONS

Owner's name: _____ Date: _____

Address: _____

Vehicle identification number: _____

Lubrication

㊦ Engine oil replacement *

*: If your vehicle use situation corresponds to one of the severe condition type (A)~(C), perform inspection or replacement according to this maintenance schedule.

⇒  P. 15-2

256,000 km / 160,000 miles
SERVICE OPERATIONS

Owner's name: _____

Date: _____

Address: _____

Total mileage: _____

Servicing dealer's name: _____

Address: _____

Signature: _____

256,000 km / 160,000 miles
SERVICE OPERATIONS

Owner's name: _____ Date: _____

Address: _____

Vehicle identification number: _____

Lubrication

- Ⓔ Engine oil replacement (or every 12 months)
- Transmission oil replacement
- Clutch control fluid replacement
- Transfer gear oil replacement <FG>
- Rear axle housing gear oil replacement
- Front axle housing gear oil replacement <FG>
- Front axle birfield joint grease replacement <FG> (or every 24 months (every 12 months *))
- Front axle kingpin bearing grease replacement <FG> (or every 24 months (every 12 months *))
- Front axle steering knuckle grease replacement <FG> (or every 24 months (every 12 months *))
- Power steering fluid replacement (or every 12 months)
- Lubrication of universal joints, slip joint (or every 24 months)
- Lubrication of double cardan joint <FG> (or every 24 months)
- Lubrication of rear suspension spring pin (or every 24 months)
- Lubrication of king pins (or every 24 months (every 12 months *))

*: If your vehicle use situation corresponds to one of the severe condition type (D)~(K), perform inspection or replacement according to this maintenance schedule.

⇒  P. 15-2

Inspection and maintenance

Engine

- ⑤ Oil filter replacement (or every 12 months)
- ⑤ Fuel filter replacement (or every 12 months)
- ⑤⑨ V-belts tension and damage (or every 12 months)
- ⑤⑨ Alternator (or every 12 months)
- ⑤ Cooling system (or every 12 months)
- ⑤⑨ Air cleaner element replacement
- ⑤⑨ Exhaust system (or every 12 months)
- ⑤ DPF (or every 12 months)
- ⑤ DEF line leakage and damage (or every 12 months)

Power train

- Clutch control fluid filter replacement
- Propeller shaft flange torque and universal joint looseness

Front and rear axle

- Tie rod ball joint dust boots (or every 24 months (every 12 months *1))

Suspension system

- Leaf suspension system
- Stabilizer rod ball joint dust boots <Vehicles with stabilizer>

Braking system

- Disc brake pad and disc (or every 24 months (every 12 months *2))
- Brake lining and drum (or every 12 months)
- Service brake system (or every 24 months (every 12 months *2))

Steering system

- Steering system
- Drag link ball joint dust boots (or every 24 months (every 12 months *1))

*1: If your vehicle use situation corresponds to one of the severe condition type (D)~(K), perform inspection or replacement according to this maintenance schedule.

*2: If your vehicle use situation corresponds to one of the severe condition type (D)~(J), perform inspection or replacement according to this maintenance schedule.

⇒  P. 15-2

264,000 km / 165,000 miles
SERVICE OPERATIONS

Owner's name: _____

Date: _____

Address: _____

Total mileage: _____

Servicing dealer's name: _____

Address: _____

Signature: _____

264,000 km / 165,000 miles
SERVICE OPERATIONS

Owner's name: _____ Date: _____

Address: _____

Vehicle identification number: _____

Lubrication

㊦ Engine oil replacement *

*: If your vehicle use situation corresponds to one of the severe condition type (A)~(C), perform inspection or replacement according to this maintenance schedule.

⇒  P. 15-2

272,000 km / 170,000 miles
SERVICE OPERATIONS

Owner's name: _____

Date: _____

Address: _____

Total mileage: _____

Servicing dealer's name: _____

Address: _____

Signature: _____

272,000 km / 170,000 miles
SERVICE OPERATIONS

Owner's name: _____ Date: _____

Address: _____

Vehicle identification number: _____

Lubrication

- Ⓔ Engine oil replacement (or every 12 months)

Inspection and maintenance

Engine

- Ⓔ Oil filter replacement (or every 12 months)

280,000 km / 175,000 miles
SERVICE OPERATIONS

Owner's name: _____

Date: _____

Address: _____

Total mileage: _____

Servicing dealer's name: _____

Address: _____

Signature: _____

280,000 km / 175,000 miles
SERVICE OPERATIONS

Owner's name: _____ Date: _____

Address: _____

Vehicle identification number: _____

Lubrication

㊦ Engine oil replacement *

*: If your vehicle use situation corresponds to one of the severe condition type (A)~(C), perform inspection or replacement according to this maintenance schedule.

⇒  P. 15-2

288,000 km / 180,000 miles
SERVICE OPERATIONS

Owner's name: _____

Date: _____

Address: _____

Total mileage: _____

Servicing dealer's name: _____

Address: _____

Signature: _____

288,000 km / 180,000 miles
SERVICE OPERATIONS

Owner's name: _____ Date: _____

Address: _____

Vehicle identification number: _____

Lubrication

- ⑤ Engine oil replacement (or every 12 months)
- Hub bearing grease replacement (or every 24 months (every 12 months *))
- Front axle birfield joint grease replacement <FG> (or every 24 months (every 12 months *))
- Front axle kingpin bearing grease replacement <FG> (or every 24 months (every 12 months *))
- Front axle steering knuckle grease replacement <FG> (or every 24 months (every 12 months *))
- Power steering fluid replacement (or every 12 months)
- Lubrication of universal joints, slip joint (or every 24 months)
- Lubrication of double cardan joint <FG> (or every 24 months)
- Lubrication of rear suspension spring pin (or every 24 months)
- Lubrication of king pins (or every 24 months (every 12 months *))

*: If your vehicle use situation corresponds to one of the severe condition type (D)~(K), perform inspection or replacement according to this maintenance schedule.

⇒  P. 15-2

Inspection and maintenance

Engine

- ⑤ Oil filter replacement (or every 12 months)
- ⑤ Fuel filter replacement (or every 12 months)
- ⑤ PCV filter replacement (or every 36 months)
- ⑤⑨ V-belts tension and damage (or every 12 months)
- ⑤⑨ Alternator (or every 12 months)
- ⑤ Cooling system (or every 12 months)
- ⑤⑨ Air cleaner element replacement
- ⑤⑨ Exhaust system (or every 12 months)
- ⑤ DPF (or every 12 months)
- ⑤ DEF line leakage and damage (or every 12 months)

Power train

- Propeller shaft flange torque and universal joint looseness

Front and rear axle

- Tie rod ball joint dust boots (or every 24 months (every 12 months *1))

Suspension system

- Leaf suspension system
- Stabilizer rod ball joint dust boots <Vehicles with stabilizer>

Braking system

- Disc brake pad and disc (or every 24 months (every 12 months *2))
- Brake lining and drum (or every 12 months)
- Service brake system (or every 24 months (every 12 months *2))

Steering system

- Steering system
- Drag link ball joint dust boots (or every 24 months (every 12 months *1))

*1: If your vehicle use situation corresponds to one of the severe condition type (D)~(K), perform inspection or replacement according to this maintenance schedule.

*2: If your vehicle use situation corresponds to one of the severe condition type (D)~(J), perform inspection or replacement according to this maintenance schedule.

⇒  P. 15-2

296,000 km / 185,000 miles
SERVICE OPERATIONS

Owner's name: _____

Date: _____

Address: _____

Total mileage: _____

Servicing dealer's name: _____

Address: _____

Signature: _____

296,000 km / 185,000 miles
SERVICE OPERATIONS

Owner's name: _____ Date: _____

Address: _____

Vehicle identification number: _____

Lubrication

㊦ Engine oil replacement *

*: If your vehicle use situation corresponds to one of the severe condition type (A)~(C), perform inspection or replacement according to this maintenance schedule.

⇒  P. 15-2

**12 months (1 year)
SERVICE OPERATIONS**

Owner's name: _____

Date: _____

Address: _____

Total mileage: _____

Servicing dealer's name: _____

Address: _____

Signature: _____

**12 months (1 year)
SERVICE OPERATIONS**

Owner's name: _____ Date: _____

Address: _____

Vehicle identification number: _____

Inspection and maintenance

Engine

㊦ Fuel line leakage and damage *

*: If your vehicle use situation corresponds to one of the severe condition type (D)~(F), perform inspection or replacement according to this maintenance schedule.

⇒  P. 15-2

**24 months (2 years)
SERVICE OPERATIONS**

Owner's name: _____

Date: _____

Address: _____

Total mileage: _____

Servicing dealer's name: _____

Address: _____

Signature: _____

**24 months (2 years)
SERVICE OPERATIONS**

Owner's name: _____ Date: _____

Address: _____

Vehicle identification number: _____

Lubrication

Brake fluid replacement

Inspection and maintenance

Engine

⑤ Fuel line leakage and damage

⑤ Coolant replacement

**36 months (3 years)
SERVICE OPERATIONS**

Owner's name: _____

Date: _____

Address: _____

Total mileage: _____

Servicing dealer's name: _____

Address: _____

Signature: _____

**36 months (3 years)
SERVICE OPERATIONS**

Owner's name: _____ Date: _____

Address: _____

Vehicle identification number: _____

Inspection and maintenance

Engine

⑤ Fuel line leakage and damage *

*: If your vehicle use situation corresponds to one of the severe condition type (D)~(F), perform inspection or replacement according to this maintenance schedule.

⇒  P. 15-2

**48 months (4 years)
SERVICE OPERATIONS**

Owner's name: _____

Date: _____

Address: _____

Total mileage: _____

Servicing dealer's name: _____

Address: _____

Signature: _____

**48 months (4 years)
SERVICE OPERATIONS**

Owner's name: _____ Date: _____

Address: _____

Vehicle identification number: _____

Lubrication

Brake fluid replacement

Inspection and maintenance

Engine

⑤ Fuel line leakage and damage

⑤ Coolant replacement

**60 months (5 years)
SERVICE OPERATIONS**

Owner's name: _____

Date: _____

Address: _____

Total mileage: _____

Servicing dealer's name: _____

Address: _____

Signature: _____

**60 months (5 years)
SERVICE OPERATIONS**

Owner's name: _____ Date: _____

Address: _____

Vehicle identification number: _____

Inspection and maintenance

Engine

⑤ Fuel line leakage and damage *

*: If your vehicle use situation corresponds to one of the severe condition type (D)~(F), perform inspection or replacement according to this maintenance schedule.

⇒  P. 15-2

**72 months (6 years)
SERVICE OPERATIONS**

Owner's name: _____

Date: _____

Address: _____

Total mileage: _____

Servicing dealer's name: _____

Address: _____

Signature: _____

**72 months (6 years)
SERVICE OPERATIONS**

Owner's name: _____ Date: _____

Address: _____

Vehicle identification number: _____

Lubrication

Brake fluid replacement

Inspection and maintenance

Engine

⑤ Fuel line leakage and damage

⑤ Coolant replacement

84 months (7 years)
SERVICE OPERATIONS

Owner's name: _____

Date: _____

Address: _____

Total mileage: _____

Servicing dealer's name: _____

Address: _____

Signature: _____

84 months (7 years)
SERVICE OPERATIONS

Owner's name: _____ Date: _____

Address: _____

Vehicle identification number: _____

Inspection and maintenance

Engine

⑤ Fuel line leakage and damage *

*: If your vehicle use situation corresponds to one of the severe condition type (D)~(F), perform inspection or replacement according to this maintenance schedule.

⇒  P. 15-2

**96 months (8 years)
SERVICE OPERATIONS**

Owner's name: _____

Date: _____

Address: _____

Total mileage: _____

Servicing dealer's name: _____

Address: _____

Signature: _____

**96 months (8 years)
SERVICE OPERATIONS**

Owner's name: _____ Date: _____

Address: _____

Vehicle identification number: _____

Lubrication

Brake fluid replacement

Inspection and maintenance

Engine

⑤ Fuel line leakage and damage

⑤ Coolant replacement

**108 months (9 years)
SERVICE OPERATIONS**

Owner's name: _____

Date: _____

Address: _____

Total mileage: _____

Servicing dealer's name: _____

Address: _____

Signature: _____

**108 months (9 years)
SERVICE OPERATIONS**

Owner's name: _____ Date: _____

Address: _____

Vehicle identification number: _____

Inspection and maintenance

Engine

㊦ Fuel line leakage and damage *

*: If your vehicle use situation corresponds to one of the severe condition type (D)~(F), perform inspection or replacement according to this maintenance schedule.

⇒  P. 15-2

**120 months (10 years)
SERVICE OPERATIONS**

Owner's name: _____

Date: _____

Address: _____

Total mileage: _____

Servicing dealer's name: _____

Address: _____

Signature: _____

**120 months (10 years)
SERVICE OPERATIONS**

Owner's name: _____ Date: _____

Address: _____

Vehicle identification number: _____

Lubrication

Brake fluid replacement

Inspection and maintenance

Engine

⑤ Fuel line leakage and damage

⑤ Coolant replacement

**132 months (11 years)
SERVICE OPERATIONS**

Owner's name: _____

Date: _____

Address: _____

Total mileage: _____

Servicing dealer's name: _____

Address: _____

Signature: _____

**132 months (11 years)
SERVICE OPERATIONS**

Owner's name: _____ Date: _____

Address: _____

Vehicle identification number: _____

Inspection and maintenance

Engine

⑤ Fuel line leakage and damage *

*: If your vehicle use situation corresponds to one of the severe condition type (D)~(F), perform inspection or replacement according to this maintenance schedule.

⇒  P. 15-2

**144 months (12 years)
SERVICE OPERATIONS**

Owner's name: _____

Date: _____

Address: _____

Total mileage: _____

Servicing dealer's name: _____

Address: _____

Signature: _____

**144 months (12 years)
SERVICE OPERATIONS**

Owner's name: _____ Date: _____

Address: _____

Vehicle identification number: _____

Lubrication

Brake fluid replacement

Inspection and maintenance

Engine

⑤ Fuel line leakage and damage

⑤ Coolant replacement

**156 months (13 years)
SERVICE OPERATIONS**

Owner's name: _____

Date: _____

Address: _____

Total mileage: _____

Servicing dealer's name: _____

Address: _____

Signature: _____

**156 months (13 years)
SERVICE OPERATIONS**

Owner's name: _____ Date: _____

Address: _____

Vehicle identification number: _____

Inspection and maintenance

Engine

㊦ Fuel line leakage and damage *

*: If your vehicle use situation corresponds to one of the severe condition type (D)~(F), perform inspection or replacement according to this maintenance schedule.

⇒  P. 15-2

**168 months (14 years)
SERVICE OPERATIONS**

Owner's name: _____

Date: _____

Address: _____

Total mileage: _____

Servicing dealer's name: _____

Address: _____

Signature: _____

**168 months (14 years)
SERVICE OPERATIONS**

Owner's name: _____ Date: _____

Address: _____

Vehicle identification number: _____

Lubrication

Brake fluid replacement

Inspection and maintenance

Engine

⑤ Fuel line leakage and damage

⑤ Coolant replacement

**180 months (15 years)
SERVICE OPERATIONS**

Owner's name: _____

Date: _____

Address: _____

Total mileage: _____

Servicing dealer's name: _____

Address: _____

Signature: _____

**180 months (15 years)
SERVICE OPERATIONS**

Owner's name: _____ Date: _____

Address: _____

Vehicle identification number: _____

Inspection and maintenance

Engine

⑤ Fuel line leakage and damage *

*: If your vehicle use situation corresponds to one of the severe condition type (D)~(F), perform inspection or replacement according to this maintenance schedule.

⇒  P. 15-2

**192 months (16 years)
SERVICE OPERATIONS**

Owner's name: _____

Date: _____

Address: _____

Total mileage: _____

Servicing dealer's name: _____

Address: _____

Signature: _____

**192 months (16 years)
SERVICE OPERATIONS**

Owner's name: _____ Date: _____

Address: _____

Vehicle identification number: _____

Lubrication

Brake fluid replacement

Inspection and maintenance

Engine

⑤ Fuel line leakage and damage

⑤ Coolant replacement

**204 months (17 years)
SERVICE OPERATIONS**

Owner's name: _____

Date: _____

Address: _____

Total mileage: _____

Servicing dealer's name: _____

Address: _____

Signature: _____

**204 months (17 years)
SERVICE OPERATIONS**

Owner's name: _____ Date: _____

Address: _____

Vehicle identification number: _____

Inspection and maintenance

Engine

⑤ Fuel line leakage and damage *

*: If your vehicle use situation corresponds to one of the severe condition type (D) ~ (F), perform inspection or replacement according to this maintenance schedule.

⇒  P. 15-2

**216 months (18 years)
SERVICE OPERATIONS**

Owner's name: _____

Date: _____

Address: _____

Total mileage: _____

Servicing dealer's name: _____

Address: _____

Signature: _____

**216 months (18 years)
SERVICE OPERATIONS**

Owner's name: _____ Date: _____

Address: _____

Vehicle identification number: _____

Lubrication

Brake fluid replacement

Inspection and maintenance

Engine

⑤ Fuel line leakage and damage

⑤ Coolant replacement

**228 months (19 years)
SERVICE OPERATIONS**

Owner's name: _____

Date: _____

Address: _____

Total mileage: _____

Servicing dealer's name: _____

Address: _____

Signature: _____

**228 months (19 years)
SERVICE OPERATIONS**

Owner's name: _____ Date: _____

Address: _____

Vehicle identification number: _____

Inspection and maintenance

Engine

④ Fuel line leakage and damage *

*: If your vehicle use situation corresponds to one of the severe condition type (D)~(F), perform inspection or replacement according to this maintenance schedule.

⇒  P. 15-2

**240 months (20 years)
SERVICE OPERATIONS**

Owner's name: _____

Date: _____

Address: _____

Total mileage: _____

Servicing dealer's name: _____

Address: _____

Signature: _____

**240 months (20 years)
SERVICE OPERATIONS**

Owner's name: _____ Date: _____

Address: _____

Vehicle identification number: _____

Lubrication

Brake fluid replacement

Inspection and maintenance

Engine

⑤ Fuel line leakage and damage

⑤ Coolant replacement

For U.S.A.

 **MITSUBISHI FUSO TRUCK OF AMERICA, Inc.**

June '16 Printed in Japan